

# Tri CTR

## Three Port Valve 1/2" ...2"



The Tri CTR is a three port valve which can be used as a diverting or a mixing valve. When used as a diverting valve the Tri CTR has one inlet (AB) and two outlets (A and B). Depending on the stem position the flow is diverted to either outlet A or outlet B.

When used as a mixing valve the Tri CTR has two inlets (A and B) and one outlet (AB). Depending on the stem position the flow is mixed between inlets A and B.

The Tri CTR can be used with on/off, floating or modulating actuators; or with thermostats with remote water temperature sensor in which case no auxiliary energy is needed for actuation.

The Tri CTR is supplied with union nuts for use with flat sealing tailpieces.

### Features

- + Use as diverting or mixing valve
- + Control with on/off, floating or modulating actuators
- + Body made of red bronze

### Specifications

Sizes	1/2" to 2"		
Versions	external threads to NPT		
Operating temperature	14...248°F		
Operating pressure	max. 232 psi		
Medium	Heating and chilled system water, for example according to VDI 2035 Water glycol mixtures with max. 50% glycol content		
Cv values and maximum differential pressure	1/2"	: 2.9	43.5 psi
	3/4"	: 5.1	29.0 psi
	1"	: 6.6	14.5 psi
	1 1/4"	: 8.4	14.5 psi
	1 1/2"	: 9.9	14.5 psi
	2"	: 11.7	10.9 psi
Actuator connection	M30 x 1.5		
Stroke	0.11 inch		
Closing force	90...150 N		

## Design and materials

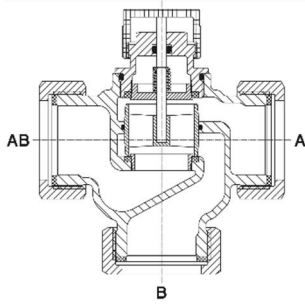

Item	Material
Body	Red bronze Rg5
Internal parts	Brass or stainless steel
Control sleeve	Plastic
Seals	EPDM
O-rings	EPDM

## Dimensions

	Size	D	L [inch]	H [inch]	H1 [inch]	SW [inch]	Weight [lbs]
	1/2"	G 3/4	2.76	2.99	1.50	1.18	1.32
	3/4"	G 1	3.15	3.46	1.85	1.46	1.76
	1"	G 1 1/4	3.54	3.58	1.97	1.81	2.65
	1 1/4"	G 1 1/2	4.33	3.78	2.17	2.05	3.31
	1 1/2"	G 1 3/4	4.53	4.17	2.52	2.68	4.85
	2"	G 2 3/8	5.12	4.41	2.56	2.95	6.39

## Item Nos.



Size	Connection size	Cv	Item No.
1/2"	G 3/4	2.9	113 12 04
3/4"	G 1	5.1	113 12 06
1"	G 1 1/4	6.6	113 12 08
1 1/4"	G 1 1/2	8.4	113 12 10
1 1/2"	G 1 3/4	9.9	113 12 12
2"	G 2 3/8	11.7	113 12 16

## Accessories

### Tailpieces

Set of three threaded tailpieces, flat sealing

Size	Item No.
NPT 1/2"	170 60 04
NPT 3/4"	170 60 06
NPT 1"	170 60 08
NPT 1 1/4"	170 60 10
NPT 1 1/2"	170 60 12
NPT 2"	170 60 16



Set of three sweat tailpieces, flat sealing

Size	Item No.
Sweat 3/4"	198 76 72
Sweat 1"	198 76 73
Sweat 1 1/2"	198 76 75



## Suitable actuators and controllers

All listed actuators and controllers are suitable for all sizes of the Tri CTR. Detailed specifications are listed in the data sheets of the products.

### Actuators

#### Aktor T thermal actuators, on/off

	Version	Item No.
	<b>24Vac</b>	
	NC, cable 3.2 ft	101 24 16
	NC, cable 6.5 ft	101 24 42
	NO, cable 3.2 ft	101 24 26

#### Aktor T thermal actuator, 0...10V modulating

	Version	Item No.
	<b>24Vac</b>	
	NC, cable 3.2 ft	101 29 53

#### Aktor M motorized actuators

	Version	Item No.
	<b>24Vac</b>	
	on/off, floating, modulating 0...10V	101 27 25
	modulating 0...10V	101 27 26
	modulating 0...10V	101 27 17
	on/off, high speed	101 27 11
	Modbus RTU	101 27 45

### Temperature controllers

#### Temperature controllers with remote sensor and immersion pocket

	Setting range	Item No.
	Capillary tube length: 6.5 ft	
	68...122°F	114 05 61
	104...158°F	114 05 62
	122...176°F	114 05 63
	158...212°F	114 05 64
	Capillary tube length: 16 ft	
	68...122°	114 05 71
	104...158°F	114 05 72
	158...212°F	114 05 74

#### Temperature controllers with strap on sensor and heat conducting base

	Setting range	Item No.
	Capillary tube length: 6.5 ft	
	68...122°F	114 28 61
	86...140°F	114 28 62
	104...158°F	114 28 63
	122...176°F	114 28 64

# Pressure loss chart

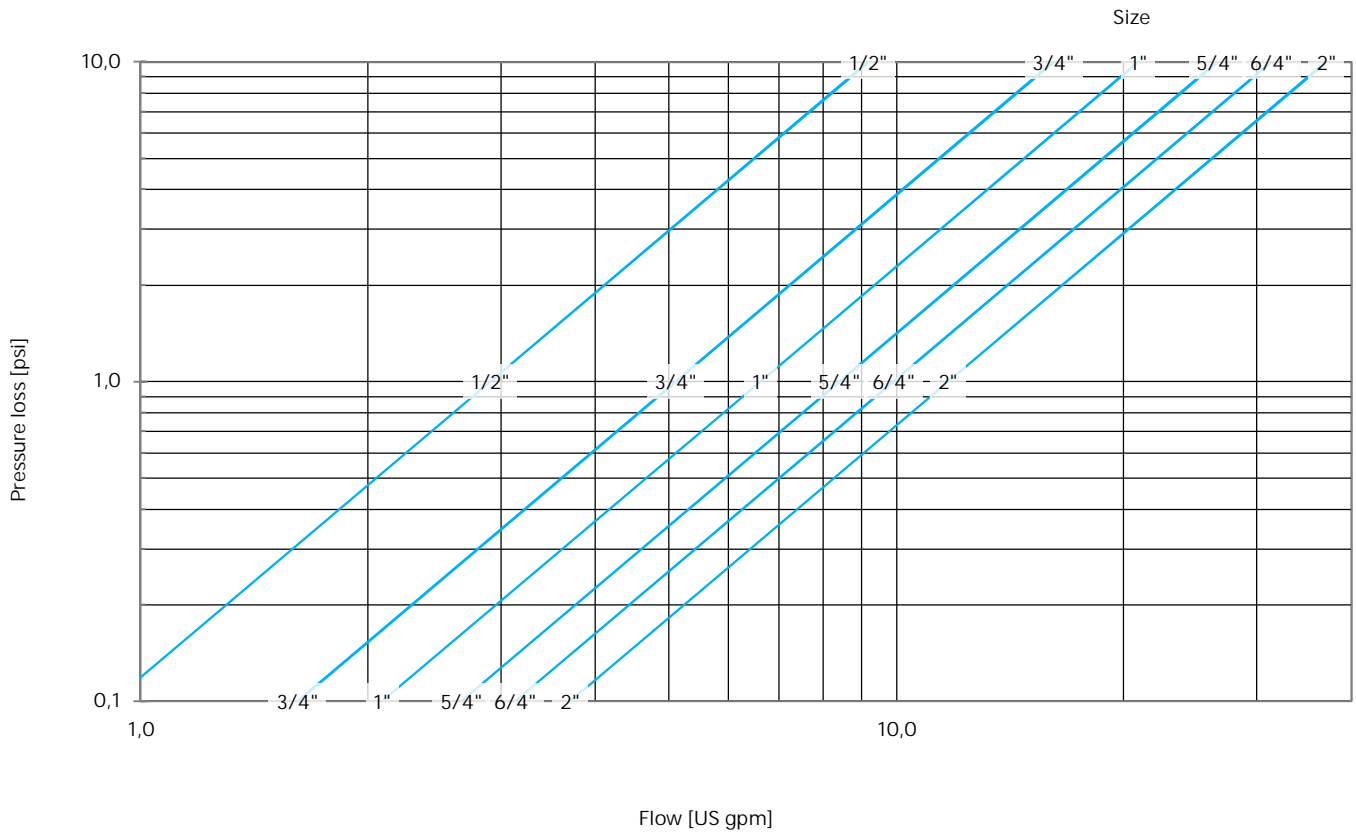

## Cv values and maximum pressure loss

	1/2"	3/4"	1"	1 1/4"	1 1/2"	2"
Cv	2.9	5.1	6.6	8.4	9.9	11.7
max. ΔP	43.5 psi	29 psi	14.5 psi	14.5 psi	14.5 psi	10.9 psi

- Cv values are valid for diverting and mixing valve
- Maximum differential pressure for positive shutoff at end positions

Subject to change • All rights reserved • © 2021 Oventrop GmbH & Co. KG  
 US-03112-11312-DB-V2125 – June 2021