

Hydraulic layouts for

Oventrop **REGTRONIC PC**

Important!

Please read the instructions carefully before installing and operating the unit!

Failure to do this can void product warranty!
Please keep the instructions in a safe place!

The unit described has been manufactured and inspected according to CE regulations.

Changes to the system

Note: 3300 is the initial software set!

Example: change system from 3300 to 3331

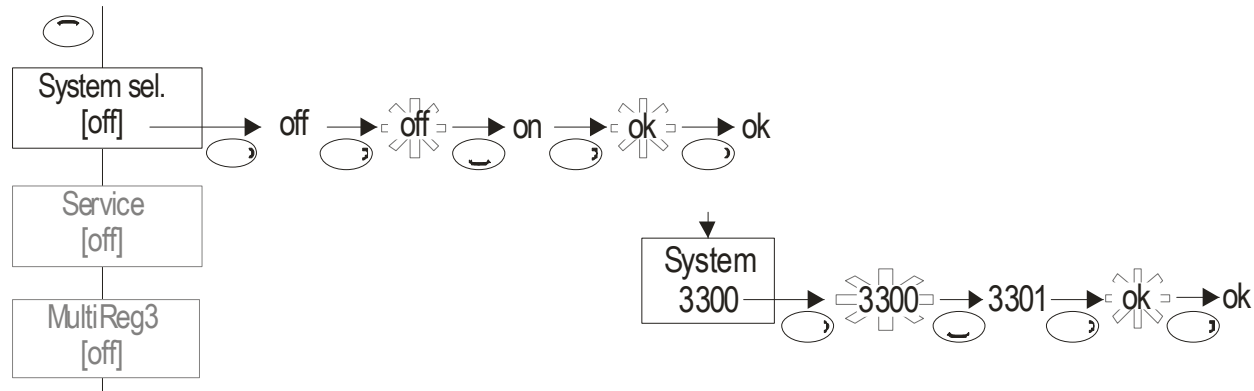

Overview of individual layouts for Regtronic PC

Layout	System	Solar circuit	Ancillary features
PC0	3330	1 collector, 1 storage tank, 1 pump	3 multi-function regulators
PC1	3331	1 collector, 2 storage tanks, 1 pump, 1 changeover valve	2 multi-function regulators
PC2	3332	1 collector, 2 storage tanks, 2 pumps	2 multi-function regulators
PC3	3333	2 collectors, 1 storage tank, 1 pump, 1 changeover valve	2 multi-function regulators
PC4	3334	2 collectors, 1 storage tank, 2 pumps	2 multi-function regulators

Note: The following layout schematics do not represent complete hydraulic system diagrams.

Layout REGUSOL PC0, system no: 3330

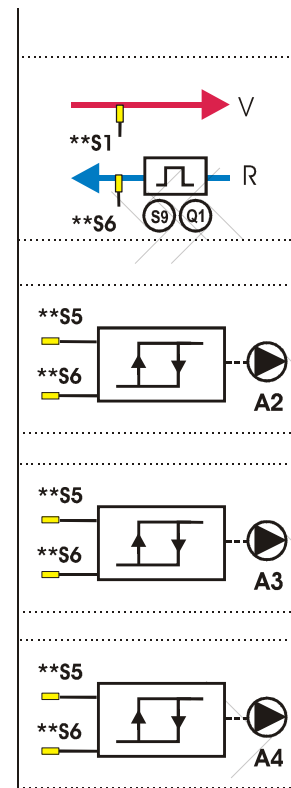
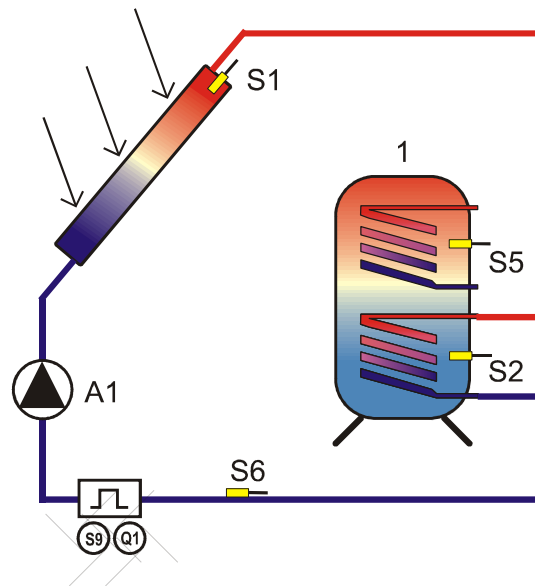
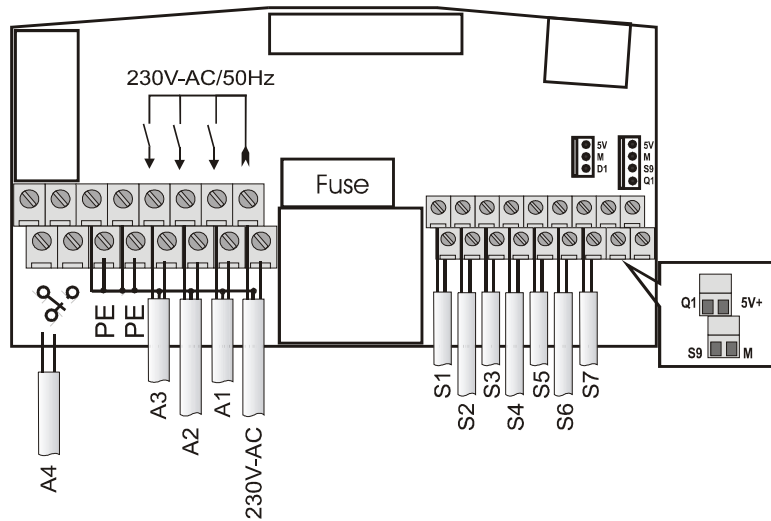

Ancillary features for Multi-function regulator

Heating, cooling, threshold switch, increased return flow, wood boiler feature, difference regulator, circulation function, alarm and timer

All sensors can be used for switching and control functions (included those already in use)
Only the output assignments are fixed.

Tx** - Select as required

Regtronic PC

Sensor connections for PC0 layout:

230 V connections for PC0 layout:

Description	Reference		Comment
	Connection terminal	Plan no.	
Collector temperature sensor	1	S1	Required for measuring the collector temperature
Temperature sensor storage tank (lower)	2	S2	Required for measuring the lower storage tank temperature
Temperature sensor	3	S3	Select as required. Not used here.
Temperature sensor	4	S4	Select as required. Not used here.
Temperature sensor storage tank (upper)	5	S5	Required for measuring the upper storage tank temperature. Sensor available for the multi-function regulator.
Return flow temperature sensor	6	S6	Optional: can be used instead of S9 for return flow yield measurement, if "Yield Measurement" function selected. Sensor available for the multi-function regulator.
Temperature sensor	7	S7	Select as required. Not used here.
VFS Grundfos sensor	VFS	VFS	Energy yield measurement with Grundfos sensor. Necessary if "Yield Measurement" activated.

Description	Reference		Comment
	Connection terminal	Plan no.	
Mains power	L1	Main s	Ensure it can be switched off. (by removing a plug or double-pole isolation)
Switched output for solar circuit pump	A1	A1	230 V connection for pump <i>RPM controlled</i> if RPM min programmed < 100%
Switched output for multi-function regulator	A2	A2	230 V connection for pump or valve If "MFR1" activated
Switched output for multi-function regulator	A3	A3	230 V connection for pump or valve If "MFR2" activated
Switched output for multi-function regulator	A4	A4	Potential-free N/O contact If "MFR3" activated. RPM control cannot be used.

Layout REGUSOL PC1, system no: 3331

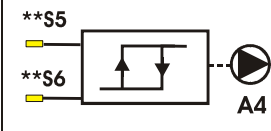
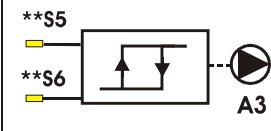
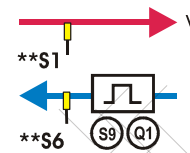
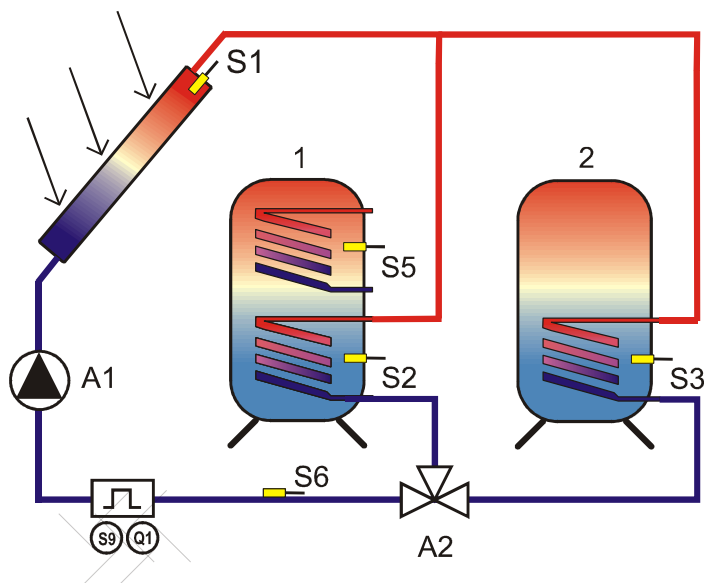
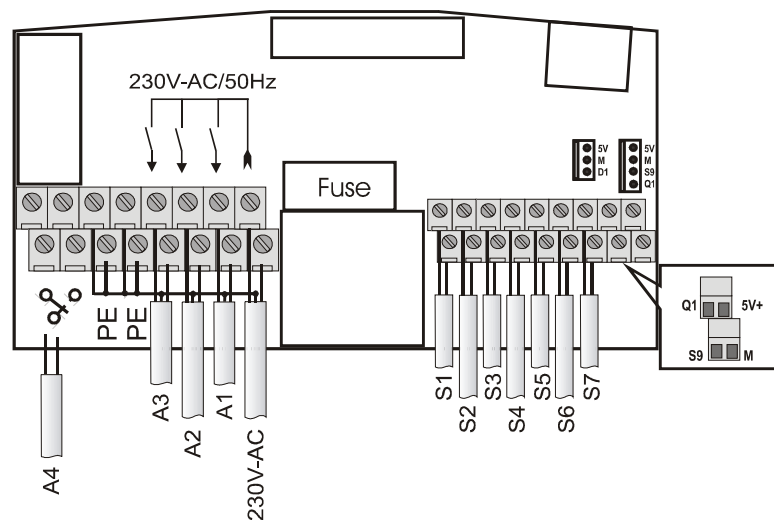

Ancillary features for Multi-function regulator

Heating, cooling, threshold switch, increased return flow, wood boiler feature, difference regulator, circulation function, alarm and timer

All sensors can be used for switching and control functions (included those already in use)
Only the output assignments are fixed.

Tx** - Select as required

Regtronic PC

Sensor connections for PC1 layout:

230 V connections for PC1 layout:

Description	Reference		Comment
	Connection terminal	Plan no.	
Collector temperature sensor	1	S1	Required for measuring the collector temperature
Storage tank 1 (lower) temperature sensor	2	S2	Required for measuring the lower storage tank temperature
Storage tank 2 (lower) temperature sensor	3	S3	Required for measuring the lower storage tank temperature
Temperature sensor	4	S4	Select as required. Not used here.
Temperature sensor storage tank (upper)	5	S5	Required for measuring the upper storage tank temperature. Sensor available for the multi-function regulator.
Return flow temperature sensor	6	S6	Optional: can be used instead of S9 for return flow yield measurement, if "Yield Measurement" function selected Sensor available for the multi-function regulator.
Temperature sensor	7	S7	Select as required. Not used here.
VFS Grundfos sensor	VFS	VFS	Energy yield measurement with Grundfos sensor. Necessary if "Yield Measurement" activated.

Description	Reference		Comment
	Connection terminal	Plan no.	
Mains power	L1	Mains	Ensure it can be switched off. (by removing a plug or double-pole isolation)
Switched output for solar circuit pump	A1	A1	230 V connection for pump <i>RPM controlled</i> if RPM min programmed < 100%
Switched output for valve	A2	A2	230 V connection for changeover valve
Switched output for multi-function regulator	A3	A3	230 V connection for pump or valve If "MFR1" activated
Switched output for multi-function regulator	A4	A4	Potential-free N/O contact If "MFR2" activated. RPM control cannot be used.

Layout REGUSOL PC2, system no: 3332

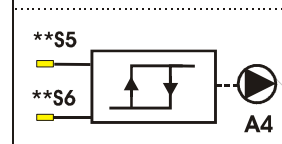
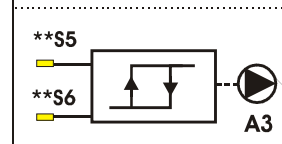
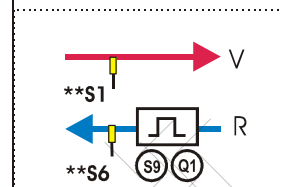
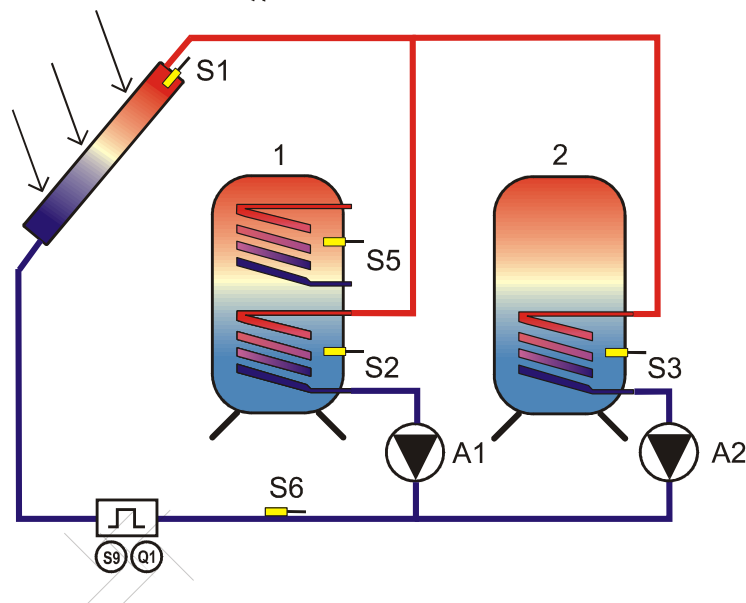
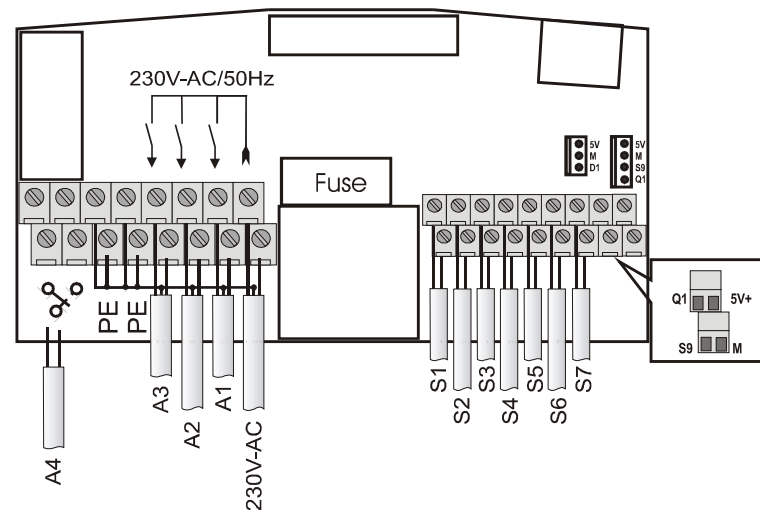

Ancillary features for Multi-function regulator

Heating, cooling, threshold switch, increased return flow, wood boiler feature, difference regulator, circulation function, alarm and timer

All sensors can be used for switching and control functions (included those already in use)

Only the output assignments are fixed.

Tx** - Select as required

Regtronic PC

Sensor connections for PC2 layout:

230 V connections for PC2 layout:

Description	Reference		Comment
	Connection terminal	Plan no.	
Collector temperature sensor	1	S1	Required for measuring the collector temperature
Storage tank 1 (lower) temperature sensor	2	S2	Required for measuring the lower storage tank temperature
Storage tank 2 (lower) temperature sensor	3	S3	Required for measuring the lower storage tank temperature
Temperature sensor	4	S4	Select as required. Not used here.
Temperature sensor storage tank (upper)	5	S5	Required for measuring the upper storage tank temperature. Sensor available for the multi-function regulator.
Return flow temperature sensor	6	S6	Optional: can be used instead of S9 for return flow yield measurement, if "Yield Measurement" function selected. Sensor available for the multi-function regulator.
Temperature sensor	7	S7	Select as required. Not used here.
VFS Grundfos sensor	VFS	VFS	Energy yield measurement with Grundfos sensor. Necessary if "Yield Measurement" activated.

Description	Reference		Comment
	Connection terminal	Plan no.	
Mains power	L1	Mains	Ensure it can be switched off. (by removing a plug or double-pole isolation)
Switched output for solar circuit pump	A1	A1	230 V connection for pump <i>RPM controlled</i> if RPM min programmed < 100%
Switched output for solar circuit pump	A2	A2	230 V connection for pump <i>RPM controlled</i> if RPM min programmed < 100%
Switched output for multi-function regulator	A3	A3	230 V connection for pump or valve If "MFR1" activated
Switched output for multi-function regulator	A4	A4	Potential-free N/O contact If "MFR2" activated. RPM control cannot be used.

Layout REGUSOL PC3, system no: 3333

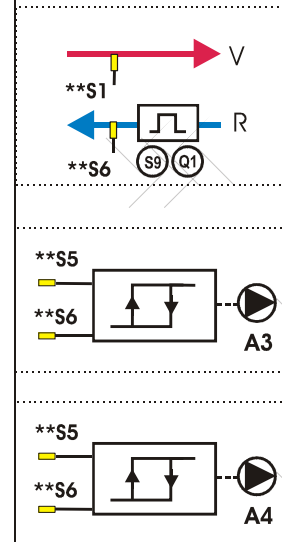
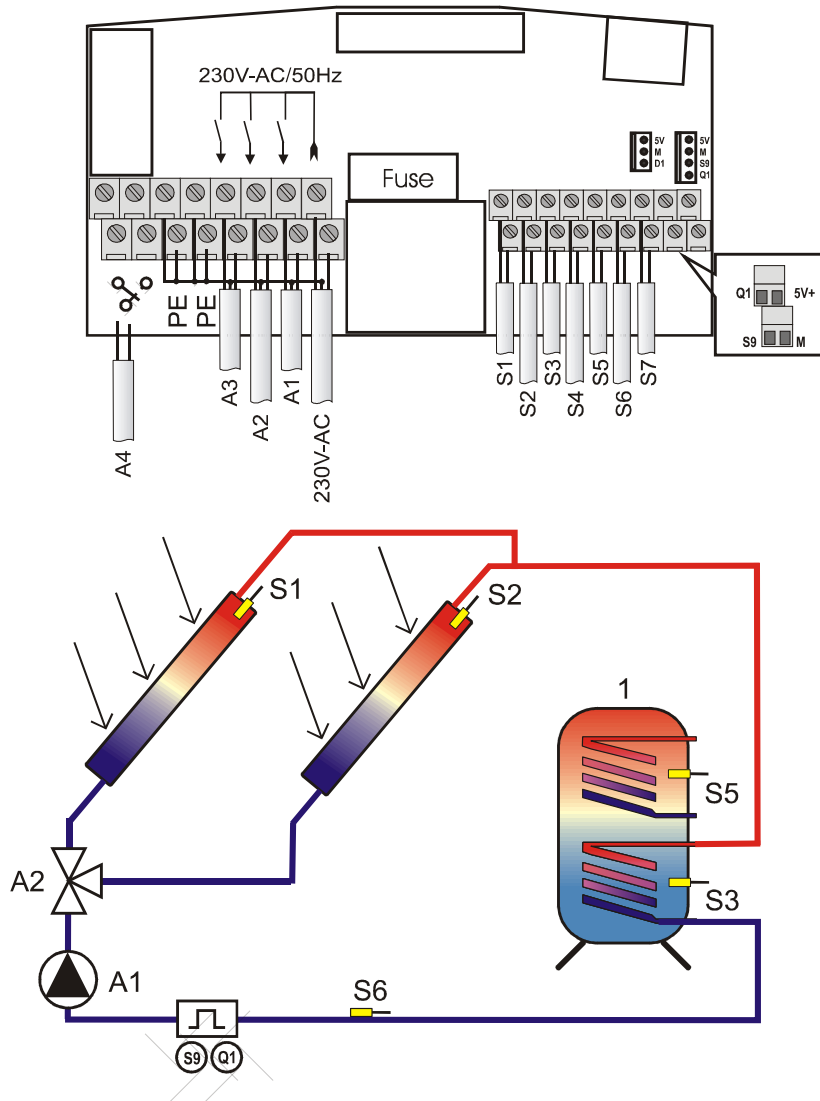

Ancillary features for Multi-function regulator

Heating, cooling, threshold switch, increased return flow, wood boiler feature, difference regulator, circulation function, alarm and timer

All sensors can be used for switching and control functions (included those already in use) Only the output assignments are fixed.

Tx** - Select as required

Regtronic PC

Sensor connections for PC3 layout:

230 V connections for PC3 layout:

Description	Reference		Comment
	Connection terminal	Plan no.	
Collector 1 temperature sensor	1	S1	Required for measuring the collector temperature
Collector 2 temperature sensor	2	S2	Required for measuring the collector temperature
Temperature sensor storage tank (lower)	3	S3	Required for measuring the lower storage tank temperature
Temperature sensor	4	S4	Select as required. Not used here.
Temperature sensor storage tank (upper)	5	S5	Required for measuring the upper storage tank temperature. Sensor available for the multi-function regulator.
Return flow temperature sensor	6	S6	Optional: can be used instead of S9 for return flow yield measurement, if "Yield Measurement" function selected Sensor available for the multi-function regulator.
Temperature sensor	7	S7	Select as required. Not used here.
VFS Grundfos sensor	VFS	VFS	Energy yield measurement with Grundfos sensor. Necessary if "Yield Measurement" activated.

Description	Reference		Comment
	Connection terminal	Plan no.	
Mains power	L1	Main s	Ensure it can be switched off. (by removing a plug or double-pole isolation)
Switched output for solar circuit pump	A1	A1	230 V connection for pump <i>RPM controlled</i> if RPM min programmed < 100%
Switched output for valve	A2	A2	230 V connection for changeover valve
Switched output for multi-function regulator	A3	A3	230 V connection for pump or valve If "MFR1" activated
Switched output for multi-function regulator	A4	A4	Potential-free N/O contact If "MFR2" activated. RPM control cannot be used.

Layout REGUSOL PC4, system no: 3334

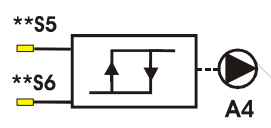
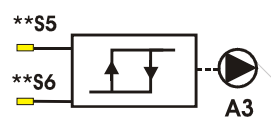
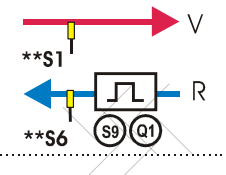
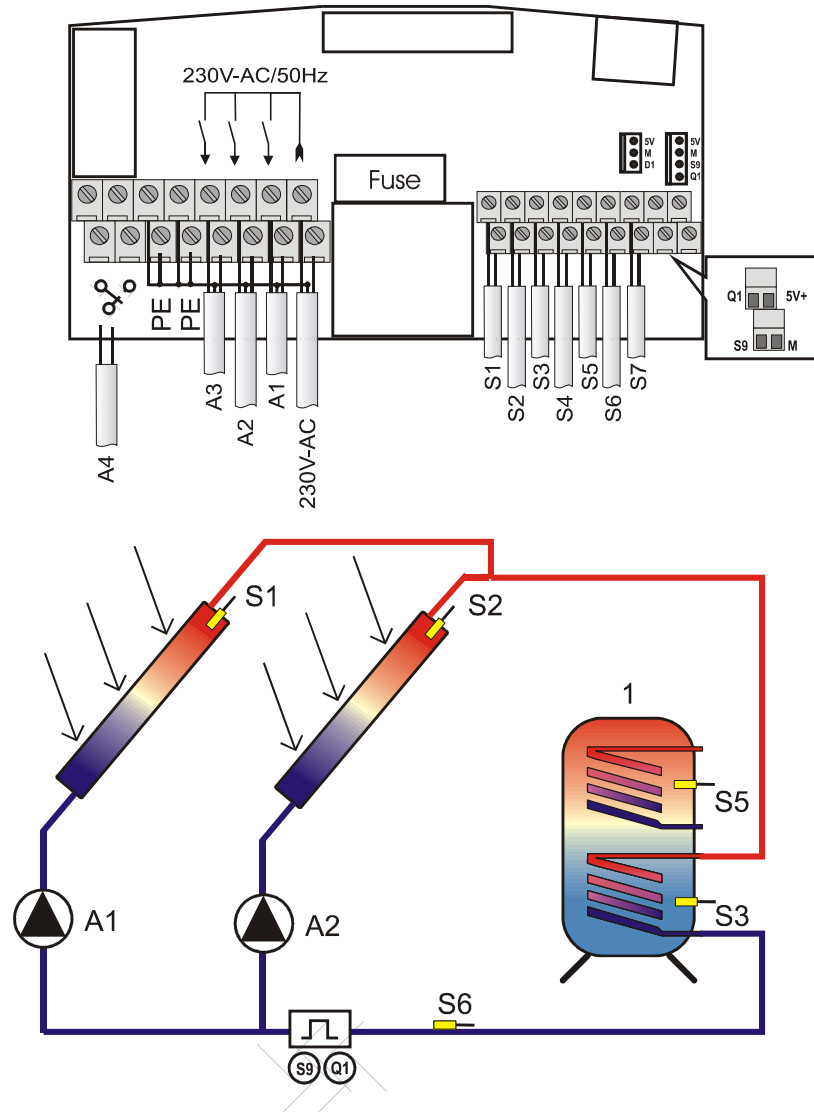

Ancillary features for Multi-function regulator

Heating, cooling, threshold switch, increased return flow, wood boiler feature, difference regulator, circulation function, alarm and timer

All sensors can be used for switching and control functions (included those already in use)

Only the output assignments are fixed.

Tx** - Select as required

Regtronic PC

Sensor connections for PC4 layout:

230 V connections for PC4 layout:

Description	Reference		Comment
	Connection terminal	Plan no.	
Collector 1 temperature sensor	1	S1	Required for measuring the collector temperature
Collector 2 temperature sensor	2	S2	Required for measuring the collector temperature
Temperature sensor storage tank (lower)	3	S3	Required for measuring the lower storage tank temperature
Temperature sensor	4	S4	Select as required. Not used here.
Temperature sensor storage tank (upper)	5	S5	Required for measuring the upper storage tank temperature. Sensor available for the multi-function regulator.
Return flow temperature sensor	6	S6	Optional: can be used instead of S9 for return flow yield measurement, if "Yield Measurement" function selected. Sensor available for the multi-function regulator.
Temperature sensor	7	S7	Select as required. Not used here.
VFS Grundfos sensor	VFS	VFS	Energy yield measurement with Grundfos sensor. Necessary if "Yield Measurement" activated.

Description	Reference		Comment
	Connection terminal	Plan no.	
Mains power	L1	Main s	Ensure it can be switched off. (by removing a plug or double-pole isolation)
Switched output for solar circuit pump	A1	A1	230 V connection for pump <i>RPM controlled</i> if RPM min programmed < 100%
Switched output for solar circuit pump	A2	A2	230 V connection for pump <i>RPM controlled</i> if RPM min programmed < 100%
Switched output for multi-function regulator	A3	A3	230 V connection for pump or valve If "MFR1" activated
Switched output for multi-function regulator	A4	A4	Potential-free N/O contact If "MFR2" activated. RPM control cannot be used.