

Regumaq X-25

Fresh Water Station



The Regumaq X-25 fresh water station is an electronically controlled product assembly with heat exchanger for the hygienic heating of potable water according to the continuous flow principle for connection to a buffer storage cylinder. Depending on the temperature and the volume flow on the potable water side, the circulation pump on the heating side is speed controlled. When selecting the fresh water station, it is necessary to consider the water quality of the area of use.

The stations consist of a plate heat exchanger, a controller box, a circulation pump, a backflow preventer, a volume flow sensor, a safety valve, temperature sensors, fill and drain ball valves and ball valves.

The compact stations are characterized by high draw-off capacities at low excess temperatures. The control technology is particularly fast and precise due to turbine sensor technology and LIN pump technology. A circulation pump can be controlled permanently, thermally or on demand.

Features

- + Compact and powerful
- + System parameters adjustable via DIP switch
- + Suitable for low temperature systems
- + Fast control technology through turbine sensor technology and LIN pump technology
- + Simple one-man installation

General data

Variants	With copper brazed heat exchanger or copper brazed heat exchanger with Sealix® protective layer
Max. operating temperature	95 °C
Max. operating pressure	10 bar
Weight	13 kg

Product Details

Technical Data

Dimensions and connections

Width x Height x Depth	400 x 625 x 240 mm
Primary and secondary circuit connections	G 1 ET, flat sealing
Circulation connection	G 1 ET, flat sealing
Flush, fill and drain ball valve connections	G ¾ ET, for hose fitting
Distance between pipe centres - primary circuit connections	100 mm
Distance between pipe centres - secondary circuit connections	250 mm
Centre distance to wall - primary circuit	105 mm
Centre distance to wall - secondary circuit	65 mm
Distance between sealing surfaces - primary to secondary side	565 mm

Hydraulic data: Primary circuit

Medium	Heating water according to VDI 2035/Ö-Norm H 5195-1, fluid category ≤ 3 according to EN 1717. Observe the specifications of the Oventrop information sheet on corrosion protection.
Kv value	2.67

Hydraulic data: Secondary circuit

Medium	Potable water. Observe the specifications of the Oventrop information sheet on corrosion protection.
Kv value	1.88
Safety valve	10 bar
Setting range potable water temperature	20...75 °C

Electrical data: Pump

Pump	Wilo Para 15-130/8-75/LIN-9
Power consumption	2...75 W

Material

Heat exchanger copper brazed	Plate material: Stainless steel 1.4401 Connections: Stainless steel 1.4404 Brazing material: Copper
Heat exchanger copper brazed with Sealix® protective layer	Plate material: Stainless steel 1.4401 Connections: Stainless steel 1.4404 Brazing material: Copper Protective layer: SiO2 basis
Pipes	Stainless steel 1.4404
Valves and fittings	Brass / DZR brass
Seals	Fibre material, EPDM
Insulation	EPP

Applications

Operating safety is only guaranteed if the product is used correctly.

The station is an electronically controlled product assembly with heat exchanger for domestic use (e.g. rental units in residential and commercial buildings). The product assembly serves the supply of heated potable water (hot water). Use the product:

- In a technically perfect condition.
- At installation locations which are directly connected to the public low-voltage network

The passage of media other than heating water through the storage cylinder and fresh water through the potable water circuit will be considered incorrect. A direct connection of the fresh water station to local and/or district heating networks may lead to malfunctions. Parallel operation with other heating system components such as heating circuit stations is not permitted.

Any other use of the product will be considered incorrect use. Claims of any kind against the manufacturer and/or its authorised representatives due to damage caused by incorrect use will not be accepted. Observance of all operating instructions is part of compliance with correct use.

Dimensions

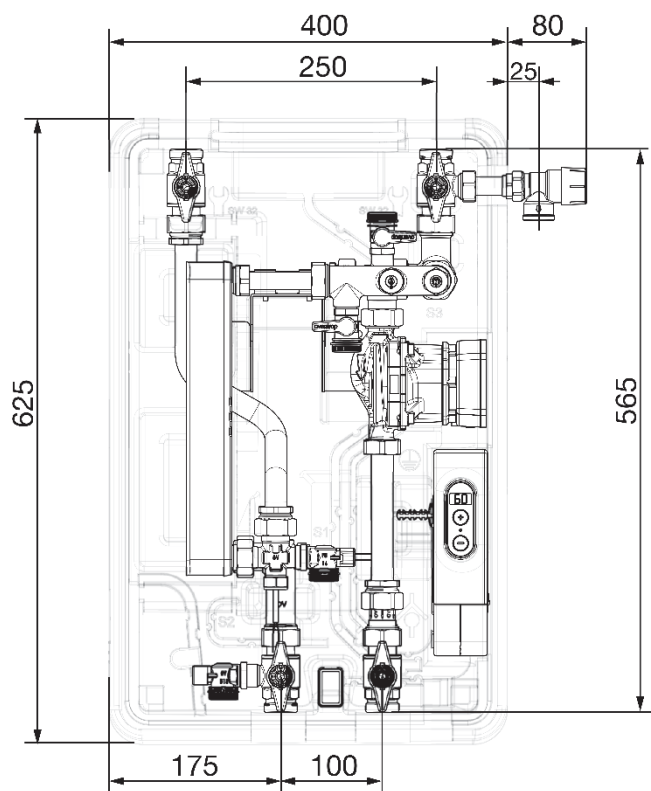

Dimension Regumaq X-25 (front view)

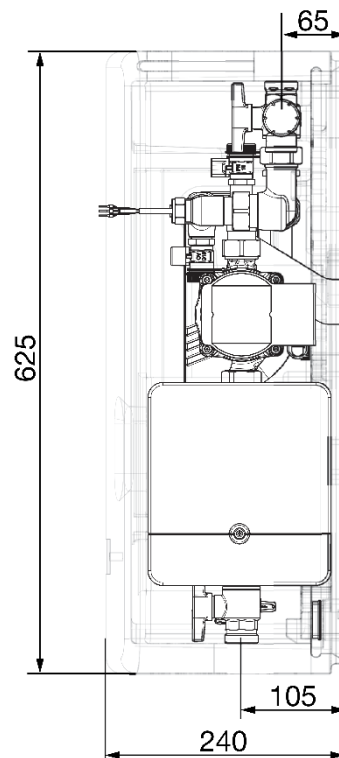

Dimensions Regumaq X-25 (side view)

Selection

Item Numbers

Regumaq X-25

Description	Item no.
Heat exchanger copper brazed	1381125
Heat exchanger copper brazed with Sealix® protective layer	1381127



Accessories

Selected accessories for the Regumaq X-25 station. For a complete overview, see product catalogue.

Description	Art.-Nr.
Potable water circulation set for Regumaq X-25, with circulation pump Wilo PARA BZ Z 15-130/7-50/SC	1381150
Potable water circulation set for Regumaq X-25, without circulation pump	1381152
Earthing clamp, DN 20...32	1359995
Strainer, both sides flat sealing external thread, with double screen insert 250 µm, PN 25, DN 20	1141006
Aquastrom P water sampling valve, DN 8, PN 10, flame resistant, bronze/stainless steel, G ¼	4209102
Aquastrom P water sampling valve, DN 10, PN 10, flame resistant, bronze/stainless steel, G ⅜	4209103

Spare Parts

Selected spare parts for the Regumaq X-25 station. For a complete overview, see product catalogue.

Designation	Item no.
Heat exchanger copper brazed	1344084
Heat exchanger copper brazed with Sealix® protective layer	1344094
Volume flow sensor, housing with slide-in turbine and hall effect sensor	1381174
Potable water temperature sensor	1381163
Check valve for Regumaq X-25 primary circuit	1381167
High-efficiency pump for Regumaq X-25 primary circuit, Wilo PARA 15-130/8-75/LIN-9	1381166
Power supply cable for Wilo PARA, with right-angle plug	1358172
Sealing ring for junction G ¾	1344497
Sealing ring for junction G 1	1344498
Controller for Regumaq X-25, cabled	1381162

Design Charts

Characteristic line Wilo Para 15-130/8-75/LIN-9

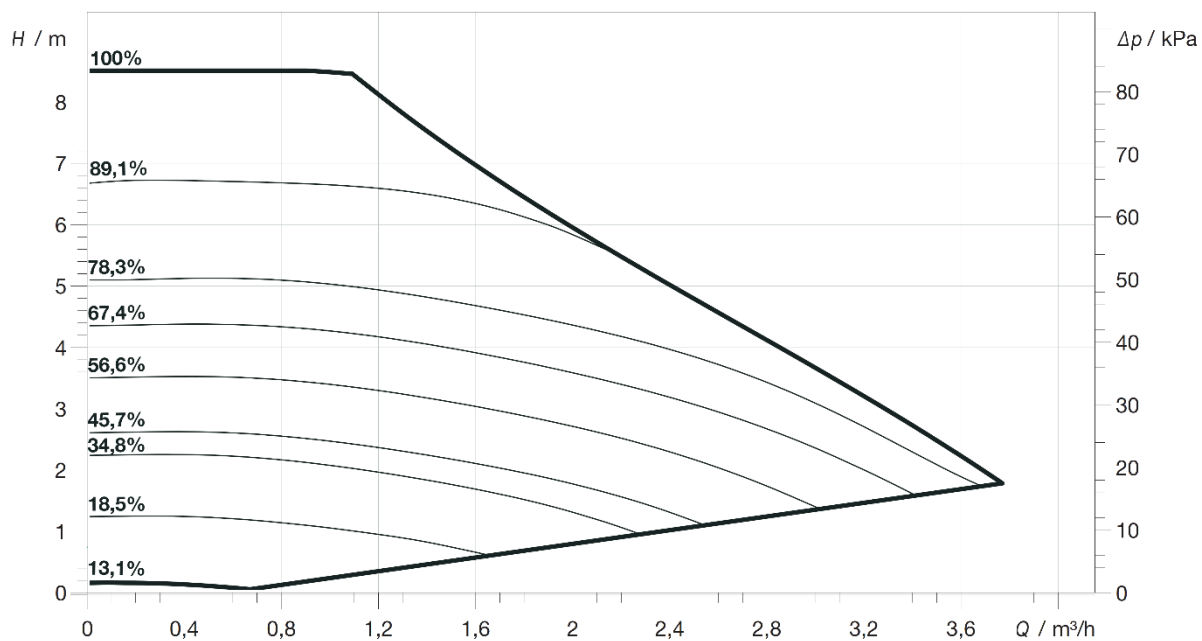

Pressure loss of the potable water circuit for potable water heating

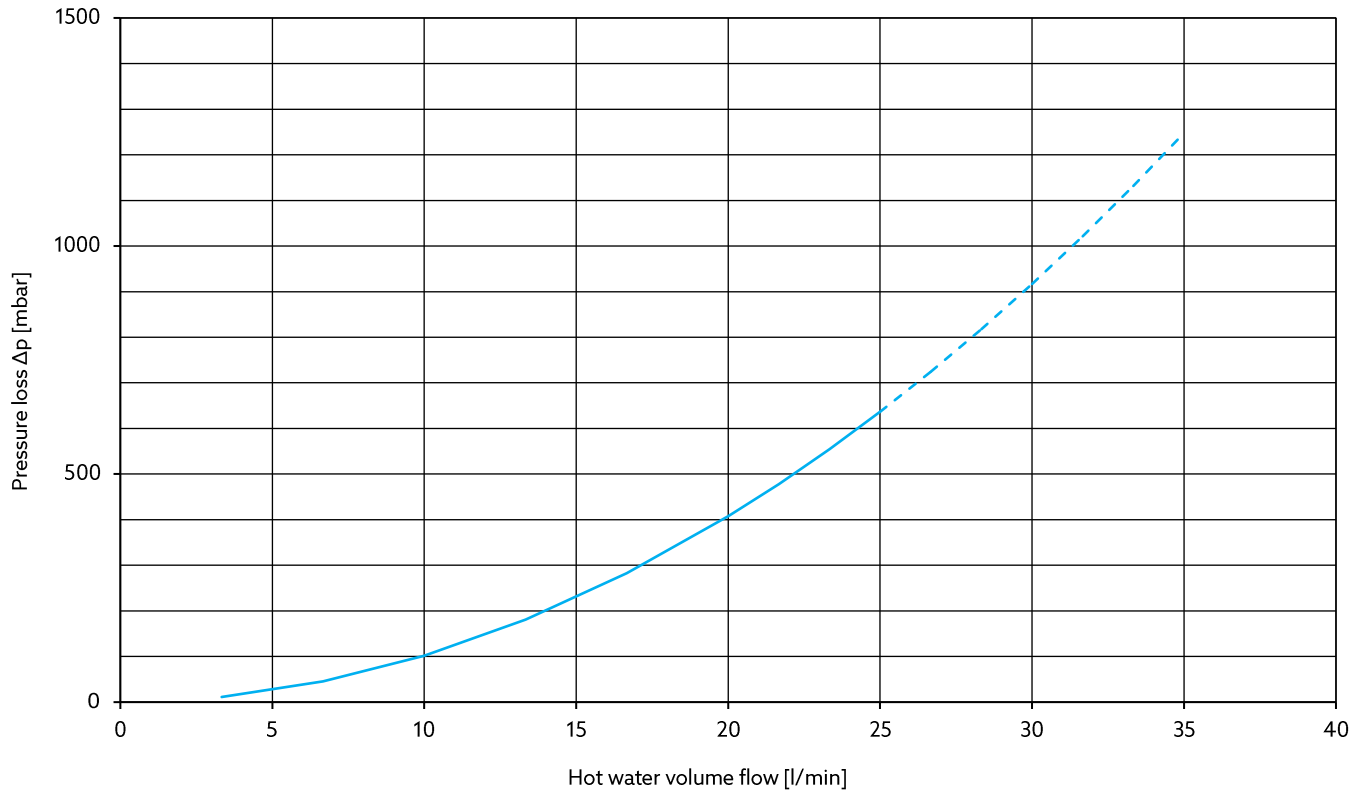

Pressure loss of the primary circuit for potable water heating

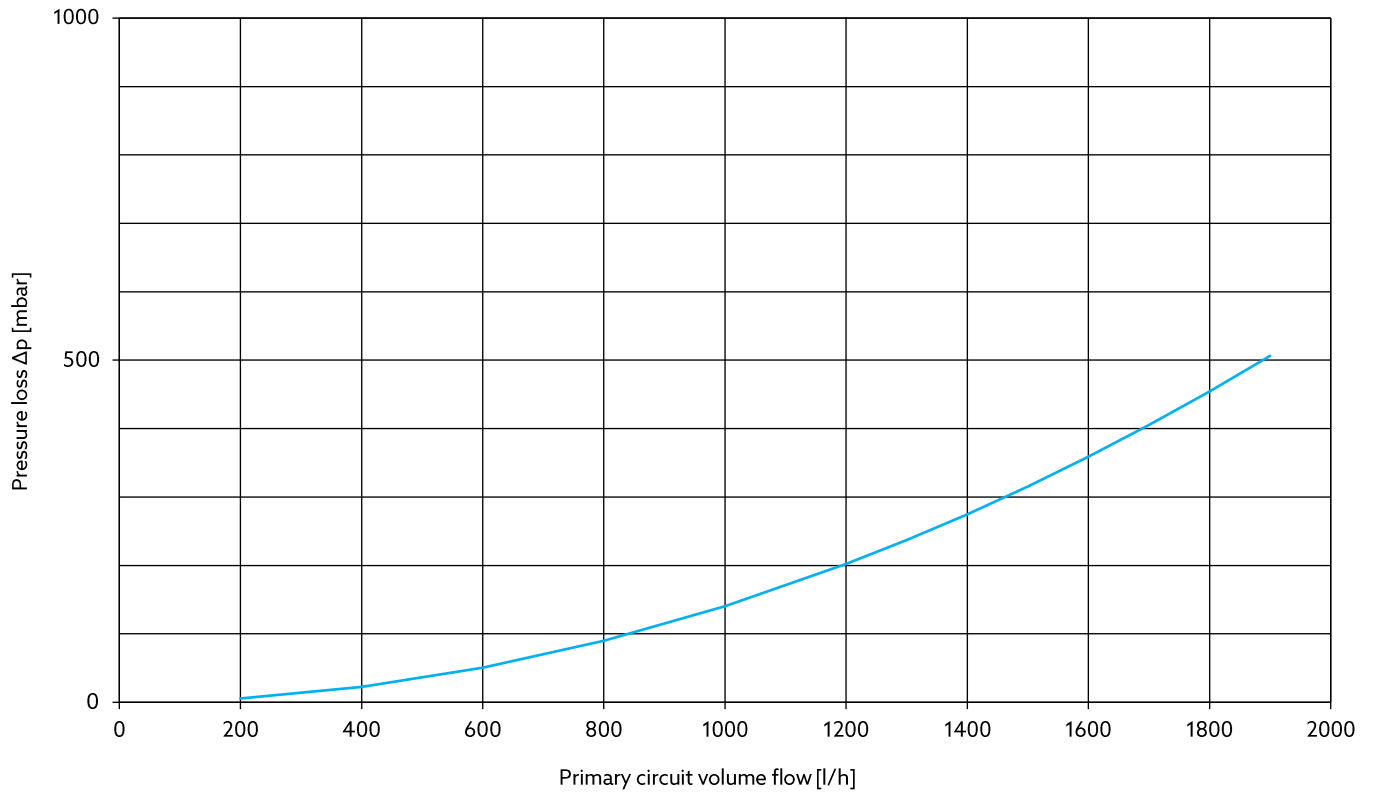

Heating of potable water from 10 °C to 45 °C

(Performance data according to SPF test procedure)

Volume flow of the storage cylinder circuit at different flow temperatures

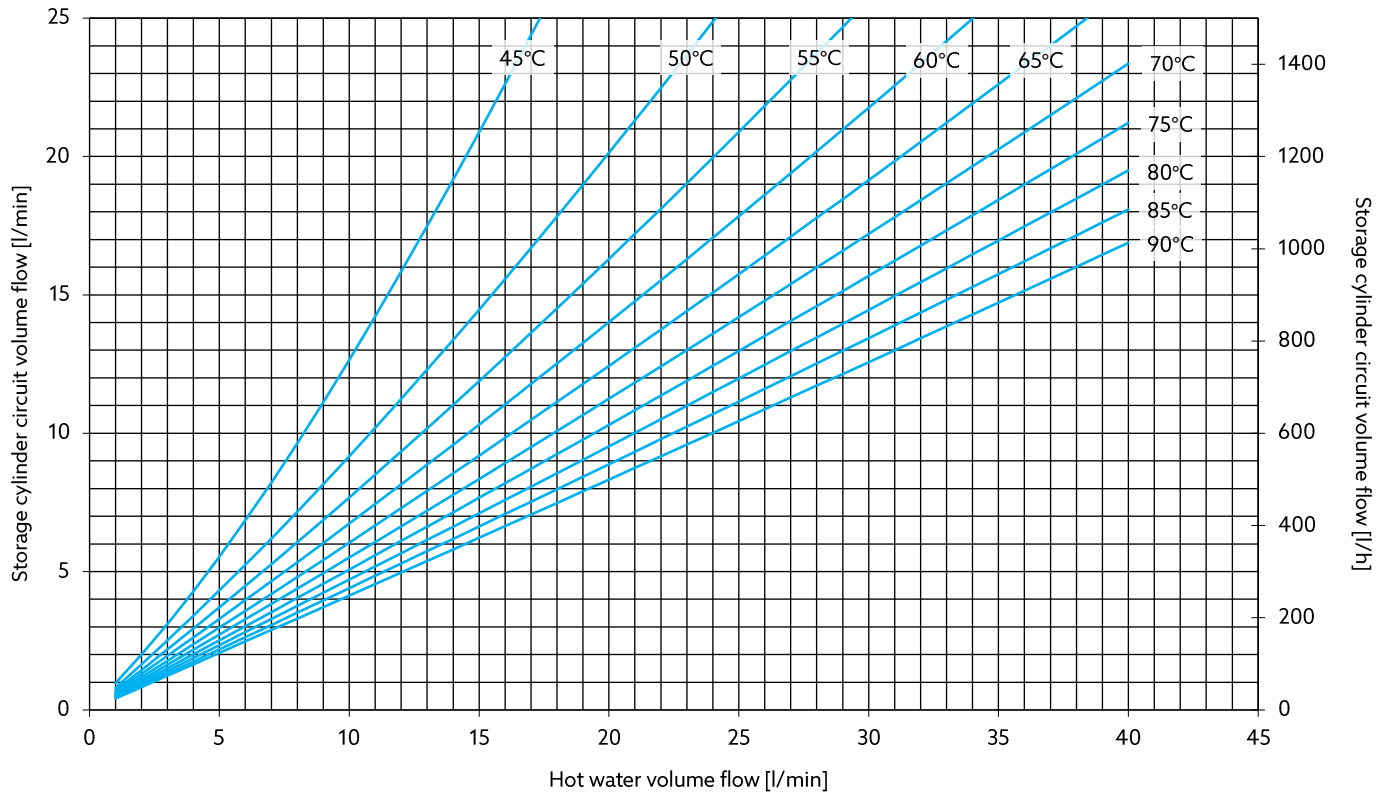

Return temperature of the storage cylinder circuit at different flow temperatures

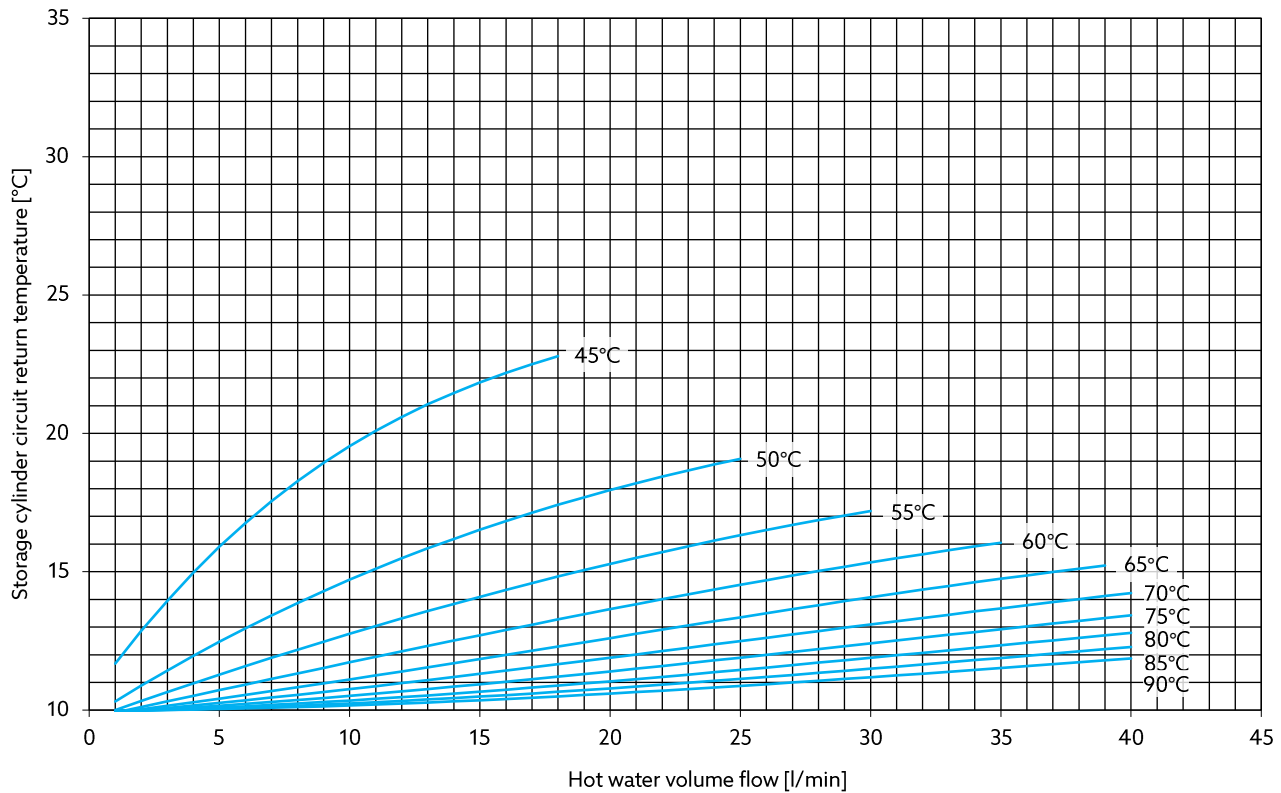

Heating of potable water from 10 °C to 50 °C

(Performance data according to SPF test procedure)

Volume flow of the storage cylinder circuit at different flow temperatures

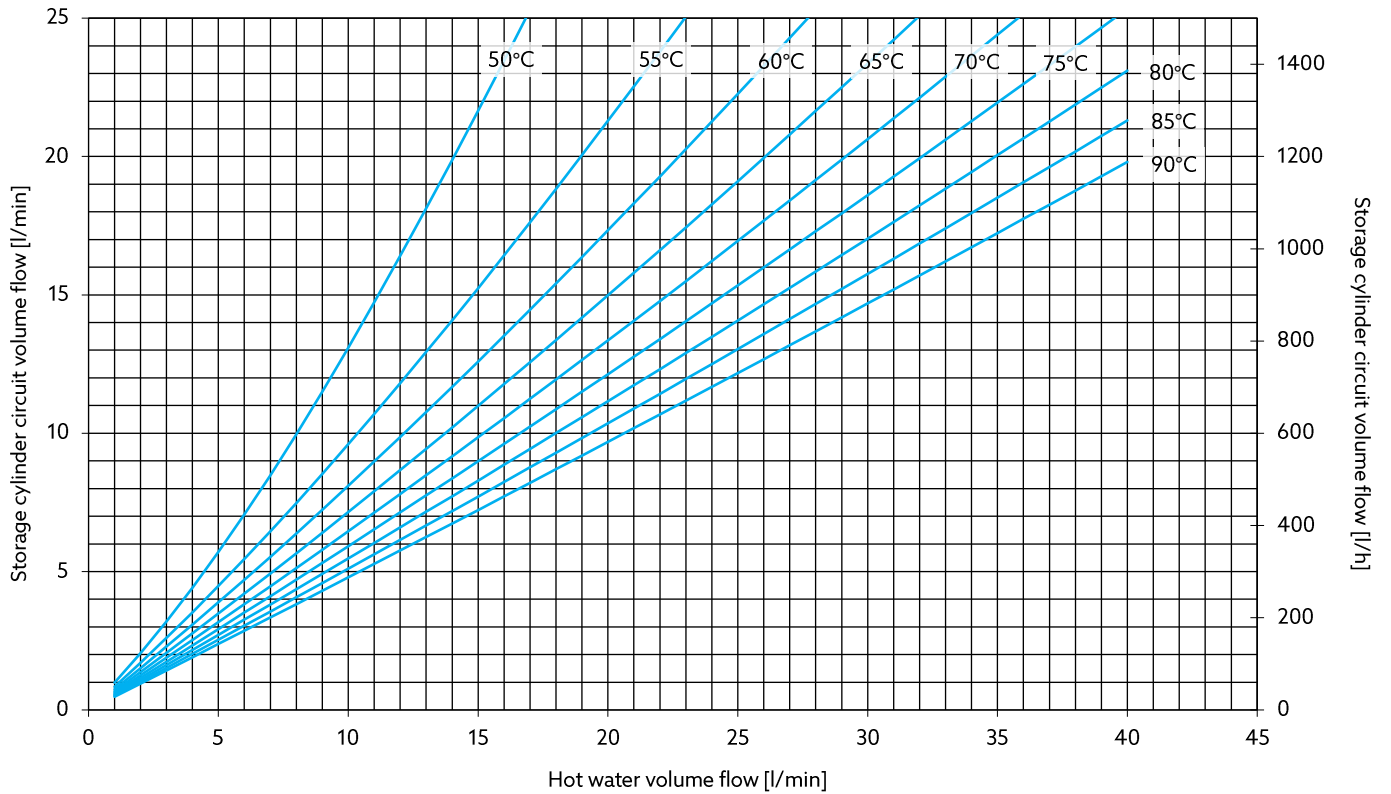

Return temperature of the storage cylinder circuit at different flow temperatures

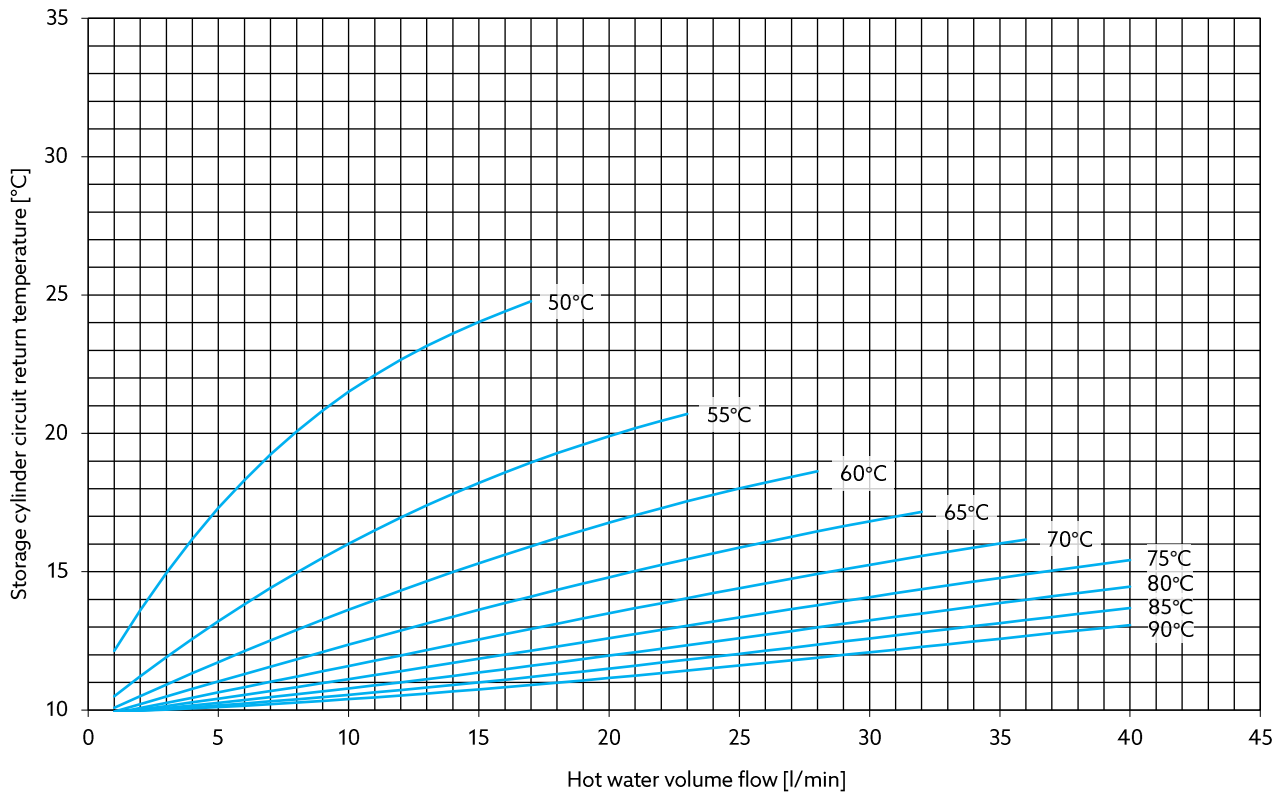

Heating of potable water from 10 °C to 55 °C

(Performance data according to SPF test procedure)

Volume flow of the storage cylinder circuit at different flow temperatures

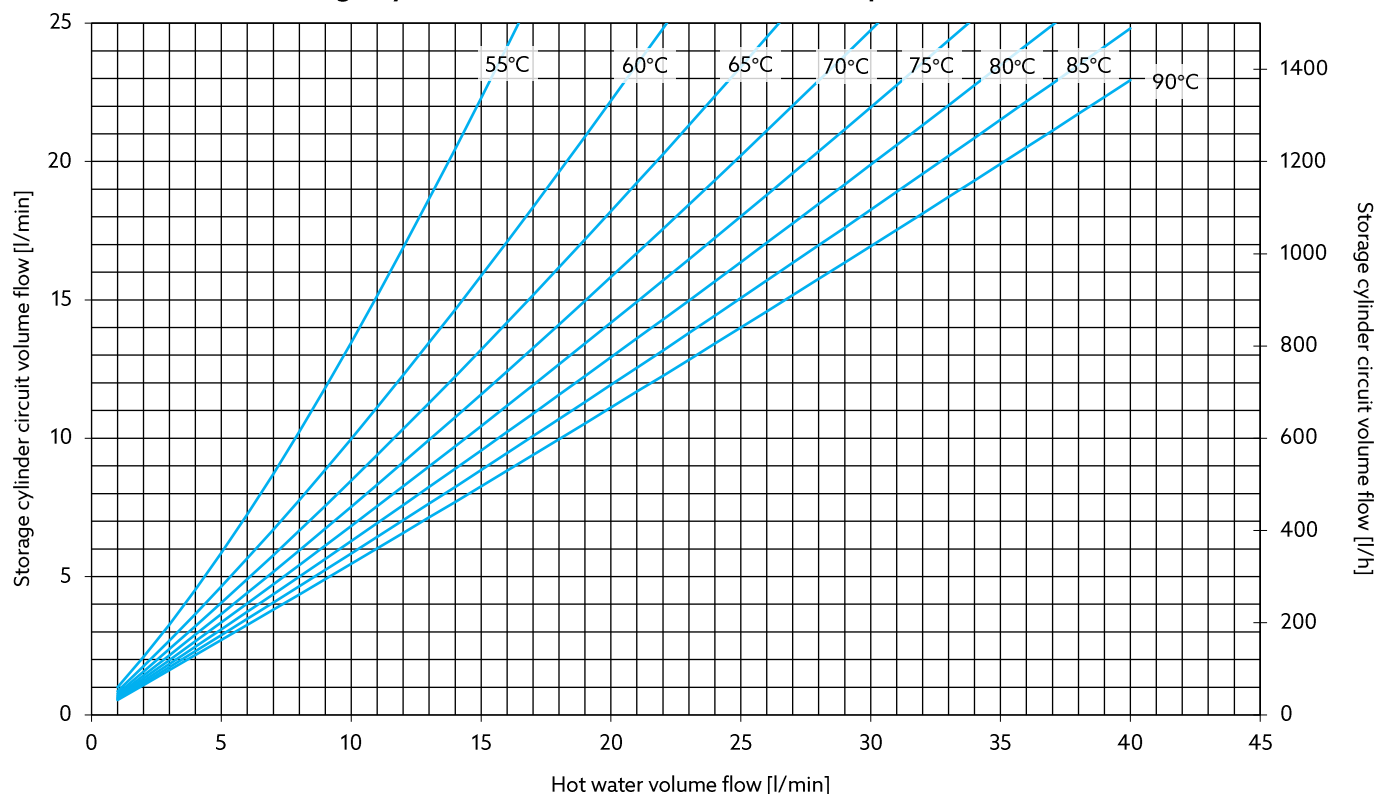

Return temperature of the storage cylinder circuit at different flow temperatures

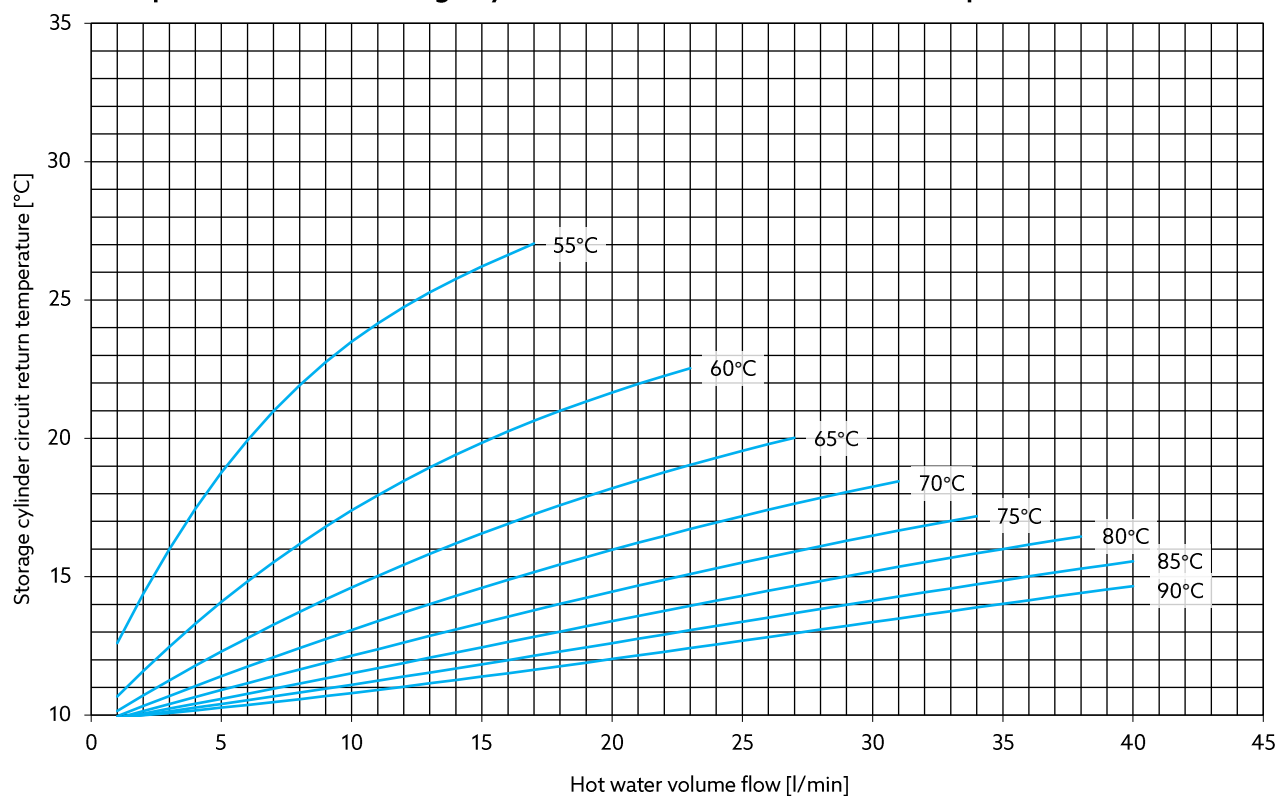

Heating of potable water from 10 °C to 60 °C

(Performance data according to SPF test procedure)

Volume flow of the storage cylinder circuit at different flow temperatures

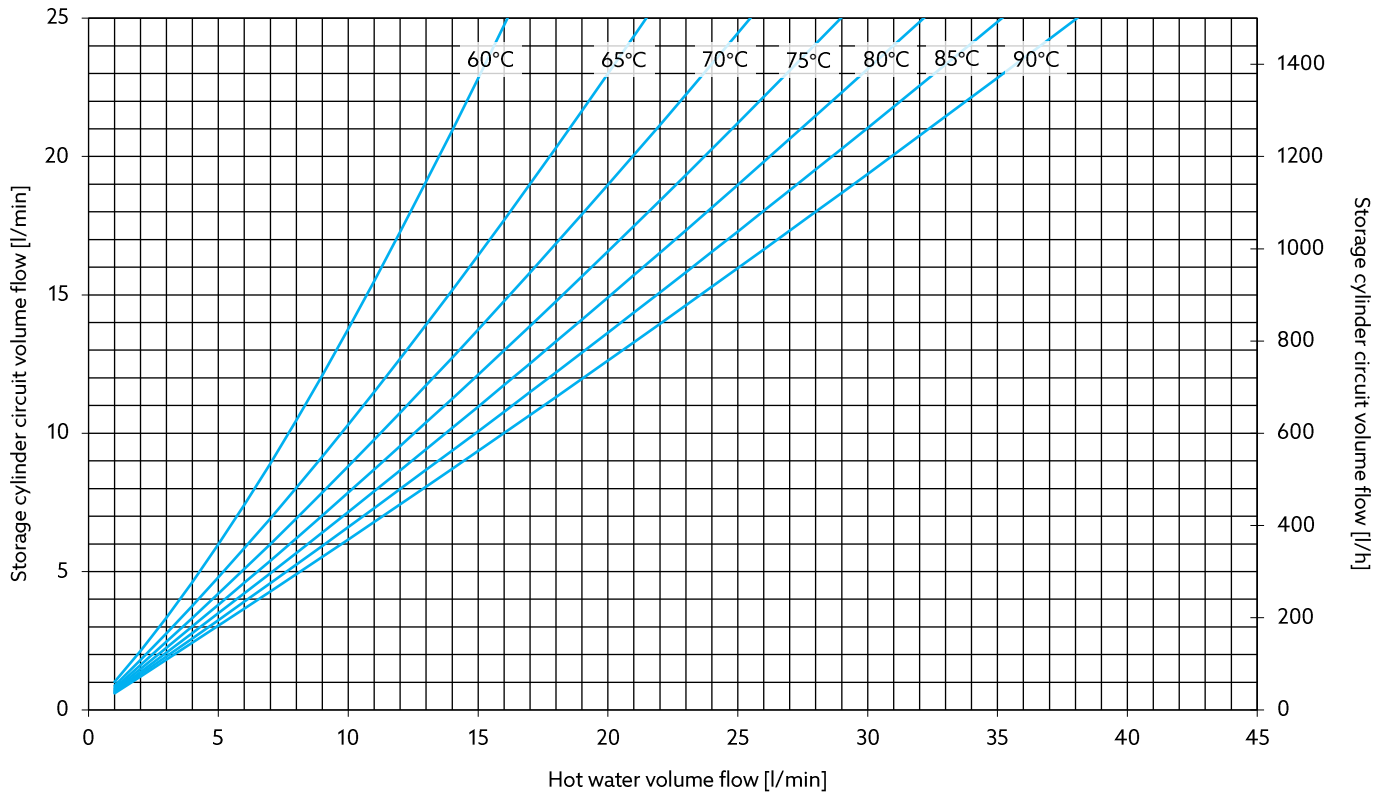

Return temperature of the storage cylinder circuit at different flow temperatures

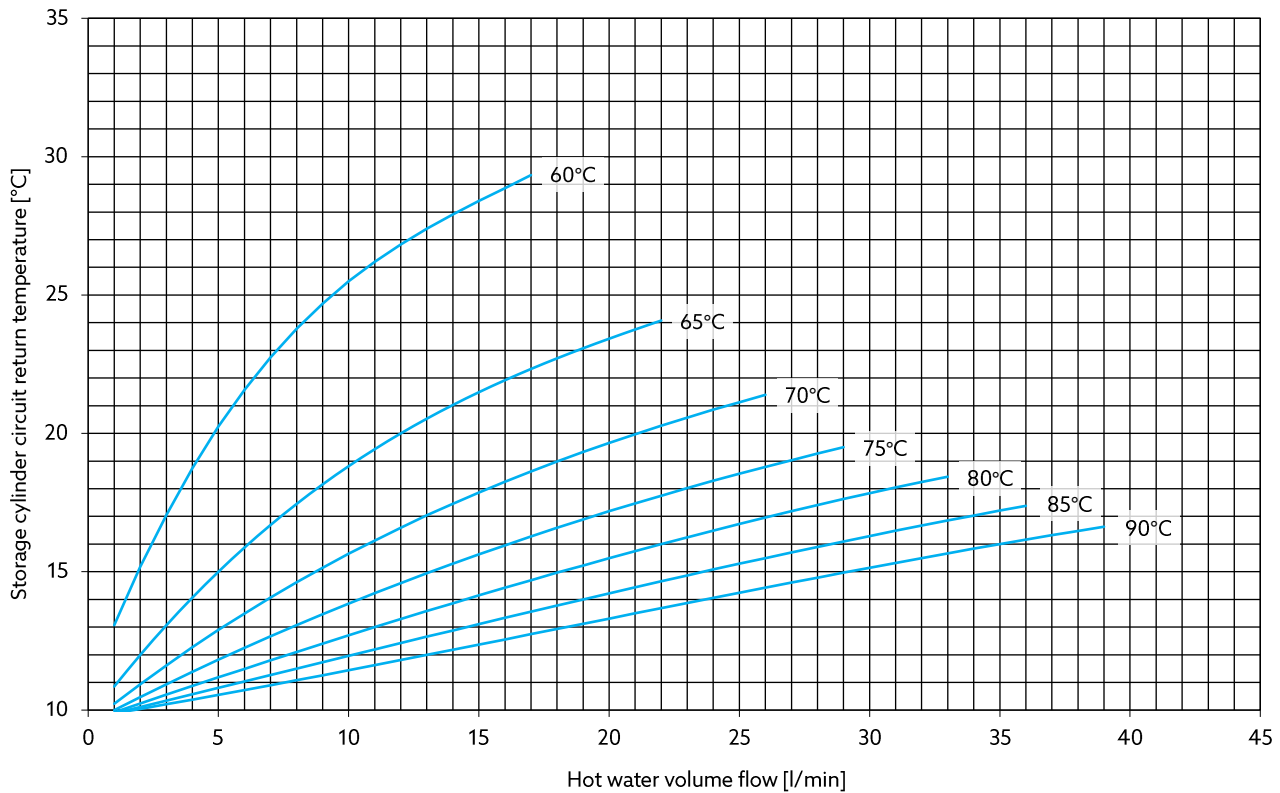

Heating of potable water from 10 °C to 65 °C

(Performance data according to SPF test procedure)

Volume flow of the storage cylinder circuit at different flow temperatures

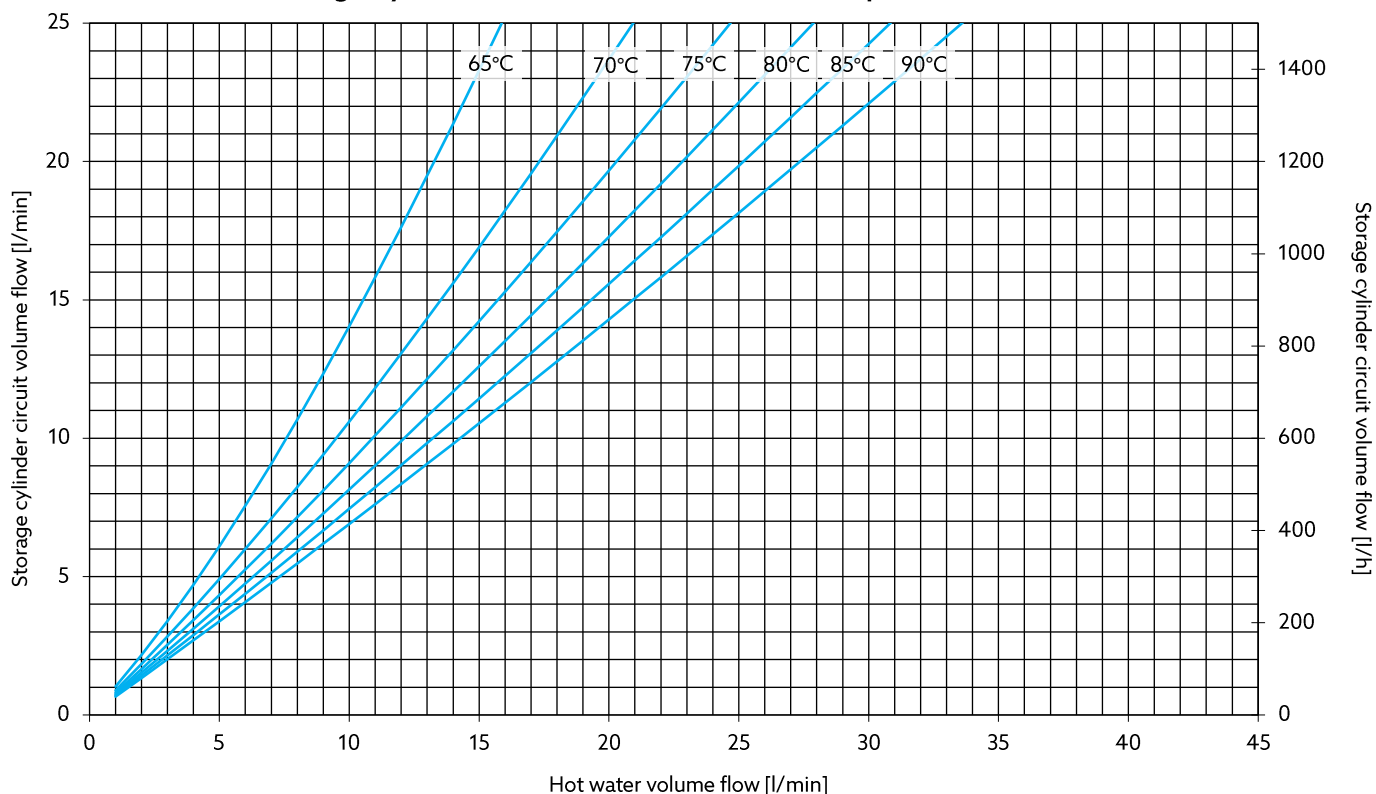

Return temperature of the storage cylinder circuit at different flow temperatures

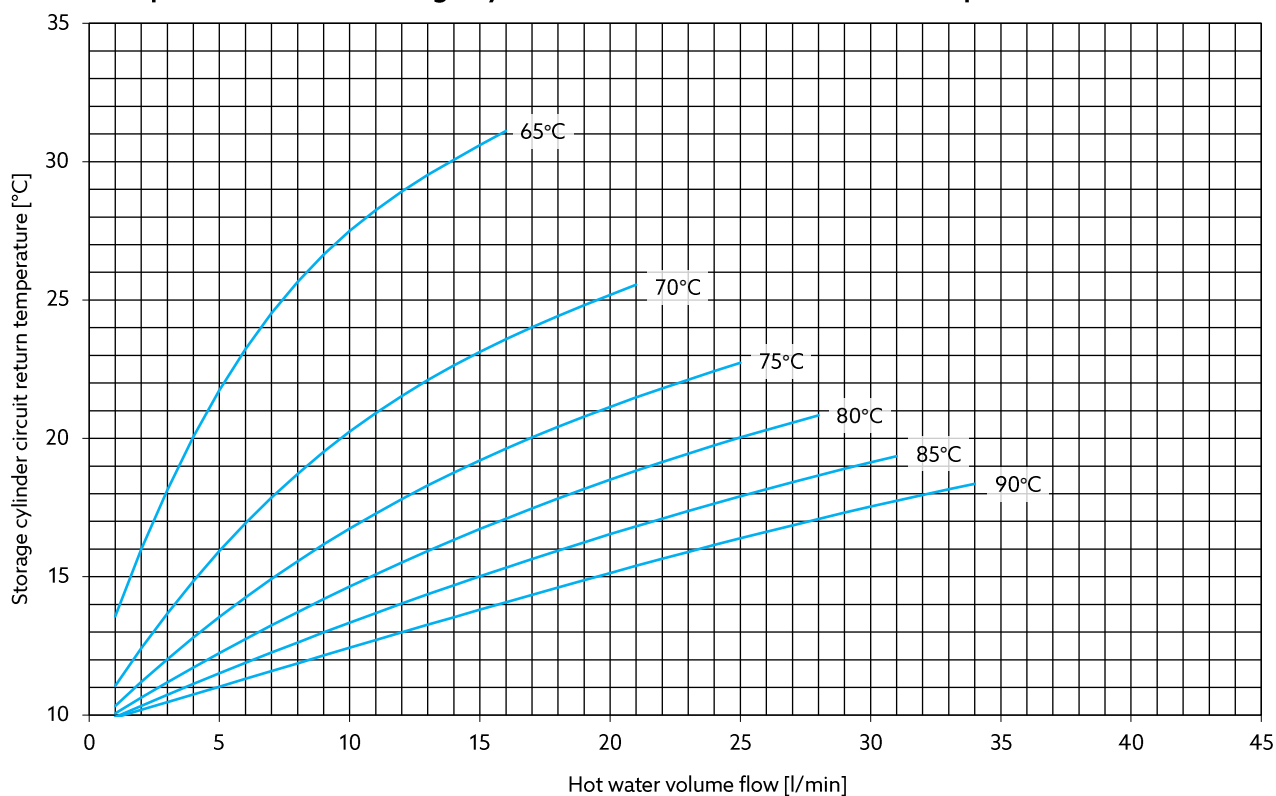

Heating of potable water from 10 °C to 70 °C

(Performance data according to SPF test procedure)

Volume flow of the storage cylinder circuit at different flow temperatures

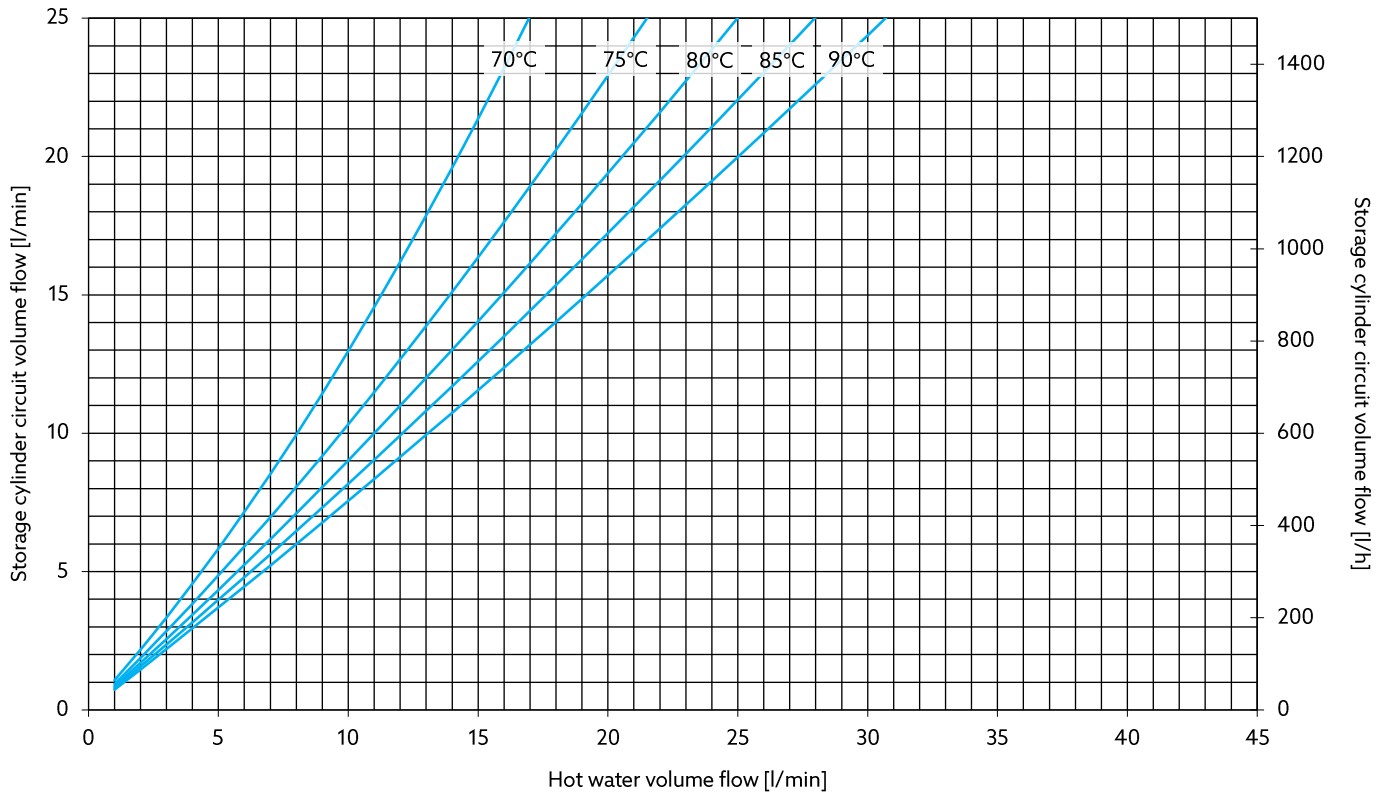

Return temperature of the storage cylinder circuit at different flow temperatures

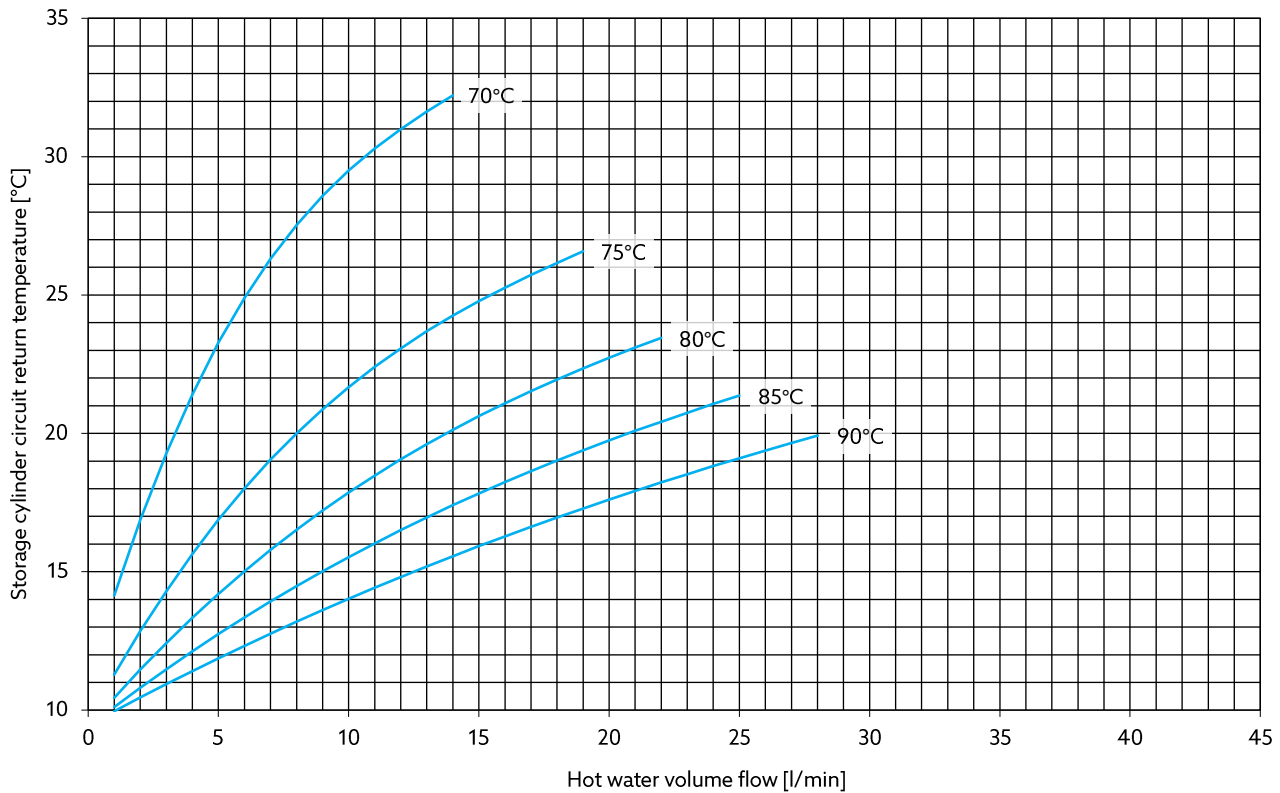

Heating of potable water from 10 °C to 75 °C

(Performance data according to SPF test procedure)

Volume flow of the storage cylinder circuit at different flow temperatures

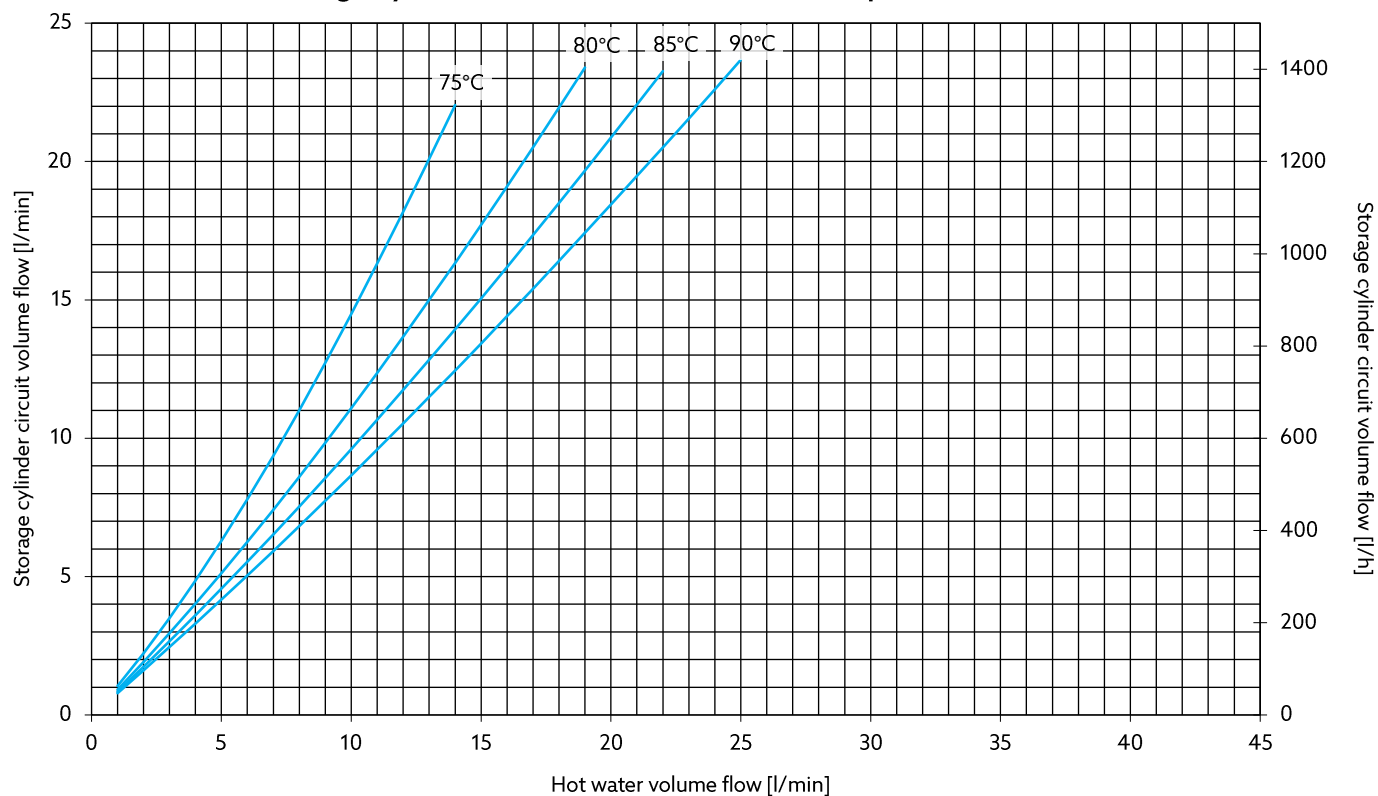

Return temperature of the storage cylinder circuit at different flow temperatures

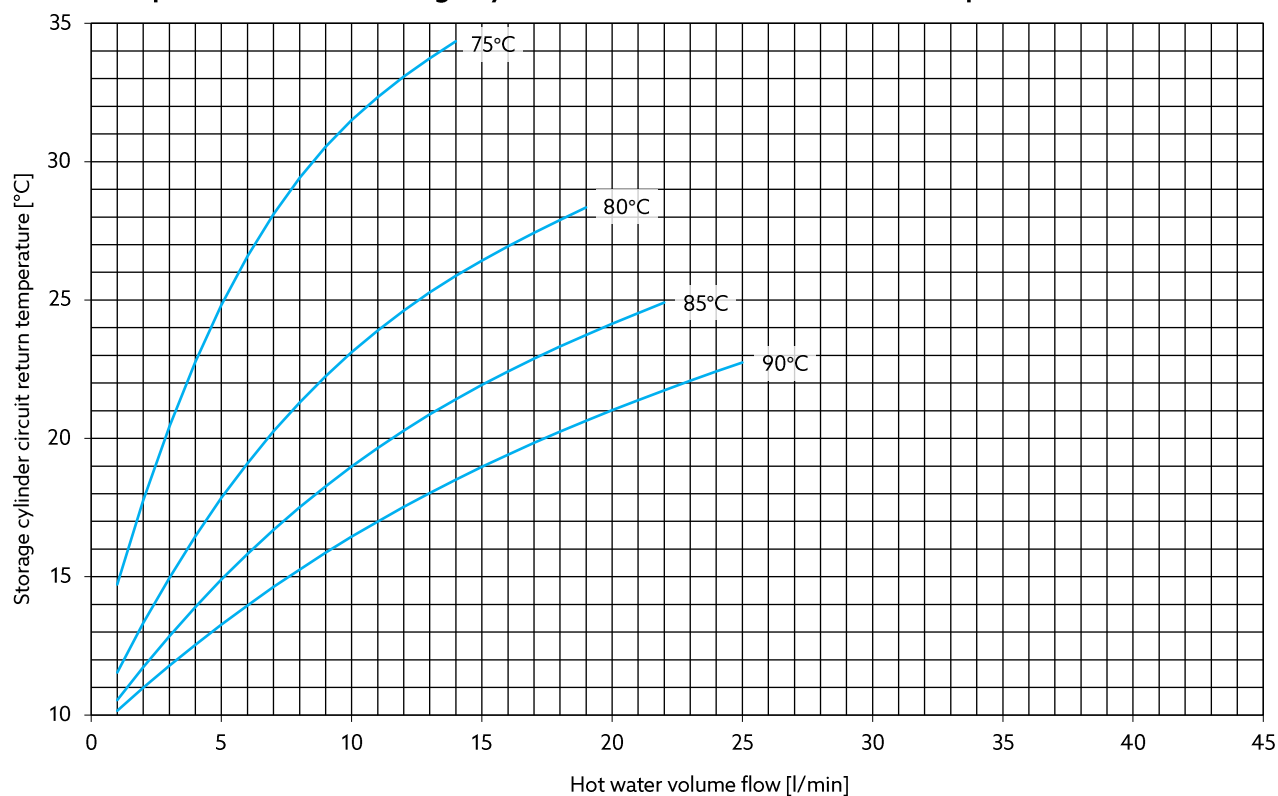

Subject to changes • All rights reserved • © 2024 Oventrop GmbH & Co. KG
EN-06202-13811-DB-V2434 – August 2024



Oventrop GmbH & Co. KG • Paul-Oventrop-Straße 1 • 59939 Olsberg • Germany
T +49 2962 820 • mail@oventrop.com • www.oventrop.com