

Differential pressure regulator “Hydromat DTR” Measuring technique “classic”

Tender specification:

The Oventrop differential pressure regulator “Hydromat DTR” for a constant control of the set nominal value is a proportional regulator which works without auxiliary energy. Infinitely adjustable nominal value between 50 and 300 mbar or between 250 and 700 mbar. The nominal value can be locked and is visible from outside. With concealed isolating facility and with ball valve for draining and filling, installation in the return pipe, oblique pattern model. Valve disc with soft seal.

Valve body, bonnet and regulator housing made on bronze, valve disc and stem made of brass resistant to dezincification (DZR), O-rings, washer and diaphragm made of EPDM.

Technical data:

Max. operating temperature t_s : +120 °C
 Min. operating temperature t_s : -20 °C
 Max. operating pressure p_s : 16 bar (PN 16)
 Max. differential pressure Δp_v : DN 15 – DN 40: 2 bar
 DN 50: 3 bar
 Length of capillary: 1 m

Models:

Differential pressure regulator both ports with female thread according to EN 10226

Size	k_{vs}	Item no. 50-300 mbar	Item no. 250-700 mbar
DN 15	2.5	1064504	1064704
DN 20	5.0	1064506	1064706
DN 25	7.5	1064508	1064708
DN 32	10.0	1064510	1064710
DN 40	15.0	1064512	1064712
DN 50	34.0	1064516	1064716

Differential pressure regulator both ports with male thread and collar nut

Size	k_{vs}	Item no. 50-300 mbar	Item no. 250-700 mbar
DN 15	2.5	1064604	1064804
DN 20	5.0	1064606	1064806
DN 25	7.5	1064608	1064808
DN 32	10.0	1064610	1064810
DN 40	15.0	1064612	1064812
DN 50	34.0	1064616	1064816

Advantages:

- all functional components in one plane
- infinitely adjustable nominal value
- very good optical display of the set nominal value
- nominal value can be locked
- simple isolation of the riser
- with ball valve for draining and filling of the riser
- pressure balanced valve disc
- existing double regulating and commissioning valves can be converted to differential pressure regulators



“Hydromat DTR”



Illustrated section

“Hydromat DTR” DN 15 to DN 50
Differential pressure regulator

Function:

Oventrop differential pressure regulators are proportional regulators working without auxiliary energy. They are designed for use in heating or cooling systems to maintain a constant differential pressure within a necessary proportional band. The spring for nominal pressure can be set with the help of the nominal value setting device. The outer chamber of the diaphragm regulator must be connected to the capillary and the capillary to the supply pipe. With the differential pressure in the installation increasing, the valve disc closes down and opens as the differential pressure falls. The excess differential pressure is reduced by the differential pressure regulator, until the set differential pressure in the riser is reached.

Installation of the regulator:

Oventrop differential pressure regulators “Hydromat DTR” are installed in the return pipe. Installation is possible in any position provided the direction of flow conforms to the direction of the arrow on the valve body. The pipework has to be flushed thoroughly before installation of the differential pressure regulator. The installation of an Oventrop “Y” type strainer is recommended. The capillary should be fitted above or horizontal to the supply pipe, to avoid blockage of the capillary by small particles, it should not be connected to the supply pipe from underneath. Pressure test of the installation only with the capillary being connected.

Setting the nominal value:

The nominal value of the Oventrop differential pressure regulator is infinitely adjustable. To do so, loosen locking screw and turn handwheel to the required nominal value. Then retighten turning screw.

Operation of the manual isolation:

The Oventrop differential pressure regulator “Hydromat DTR” can be closed off manually, e.g. for servicing the system, and additionally acts as an isolating valve. To carry out manual isolation, remove locking screw from the handwheel and close the valve with a 3 mm Allen key with the capillary of the upper chamber of the diaphragm regulator being connected to the supply pipe.

If the regulator is to be reopened after servicing, reopen screw fully with the Allen key. A perfect regulation is only possible in this position.

Draining and filling of the installation:

The installation may be drained and filled with the help of the two ball valves. Close the ball valve in the supply pipe before dismantling the capillary. During this operation, a minimum quantity of water may escape. Fit G 1/2 hoses onto both ball valves and open ball valves to drain or fill the installation.

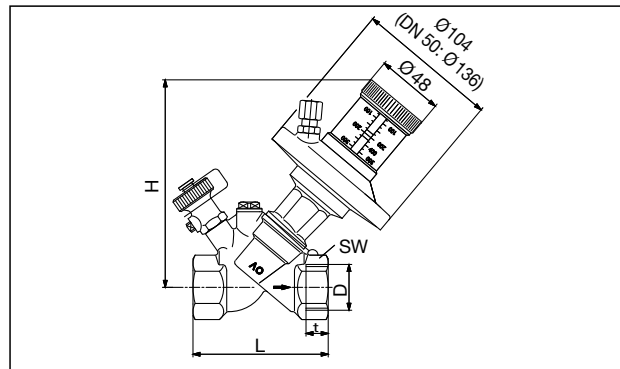

Item no.:	D EN 10226	t	SW*	L	H
10645/4704	Rp 1/2	13.2	27	80	158
10645/4706	Rp 3/4	14.5	32	84	160
10645/4708	Rp 1	16.8	41	97,5	163
10645/4710	Rp 1 1/4	19.1	50	110	172
10645/4712	Rp 1 1/2	19.1	54	120	178
10645/4716	Rp 2"	25.7	70	150	210

Dimensions *SW = spanner size

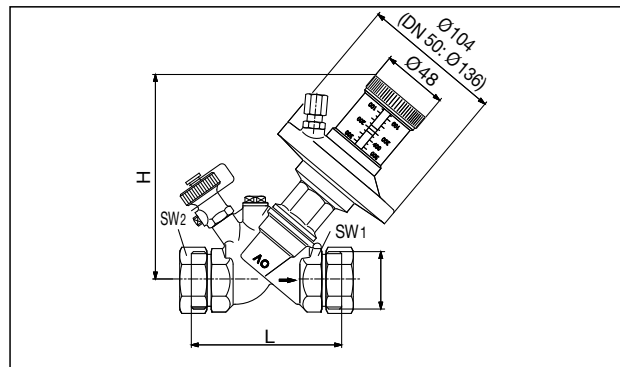

Item no.:	DN	D ISO 228	SW1*	SW2*	L	H
10646/4804	15	G 3/4	27	30	88	158
10646/4806	20	G 1	32	37	93	160
10646/4808	25	G 1 1/4	41	46	110	163
10646/4810	32	G 1 1/2	50	52	110	172
10646/4812	40	G 1 3/4	54	58	120	178
10646/4816	50	G 2"	65	75	150	210

Dimensions *SW = spanner size

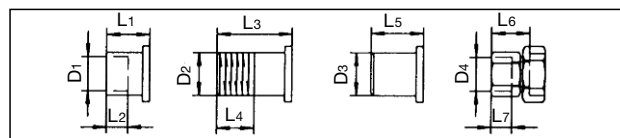

DN	D1	L1	L2	D2 EN 10226	L3	L4	D3	L5	D4 EN 10226	L6	L7
15	15	18	12	R 1/2	31	13.2	20.5	50	Rp 1/2	37	13.2
20	18	23	15	R 3/4	34	14.5	26	50	Rp 3/4	38	14.5
20	22	24	17								
25	28	27	20	R 1	40	16.8	33	60	Rp 1	53	16.8
32	35	32	25	R 1 1/4	46	19.1	41	60	Rp 1 1/4	55	19.1
40	42	37	29	R 1 1/2	49	19.1	47.5	65			
50	54	50	40	R 2	55	23.4	60	65			

Dimensions

Performance data:

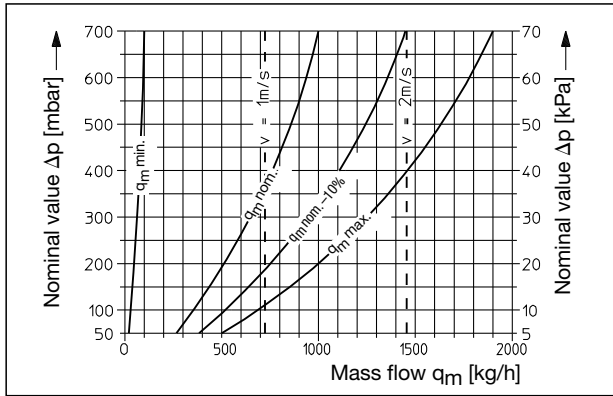

DN 15: $k_{vs} = 2.5$

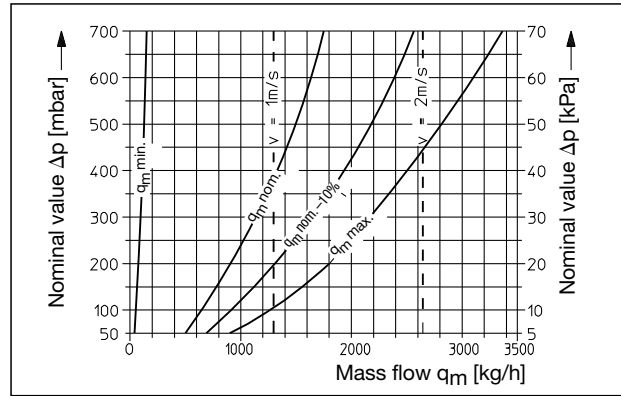

DN 20: $k_{vs} = 5.0$

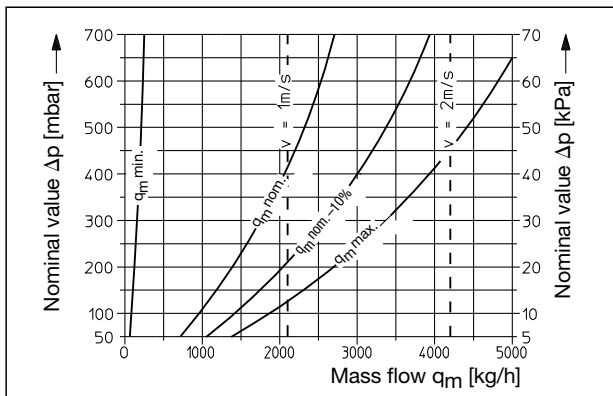

DN 25: $k_{vs} = 7.5$

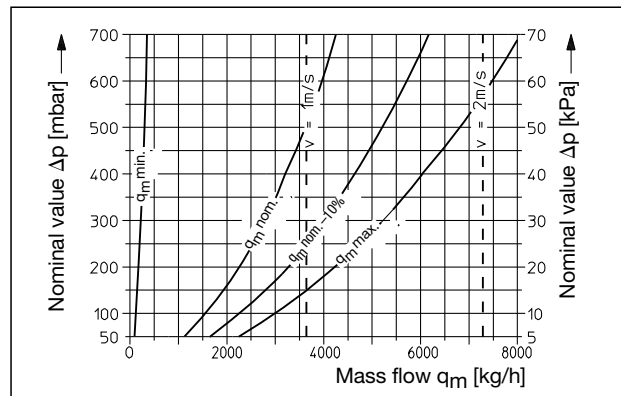

DN 32: $k_{vs} = 10.0$

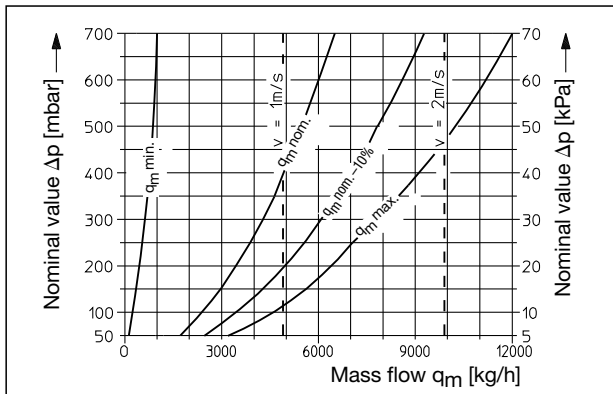

DN 40: $k_{vs} = 15.0$

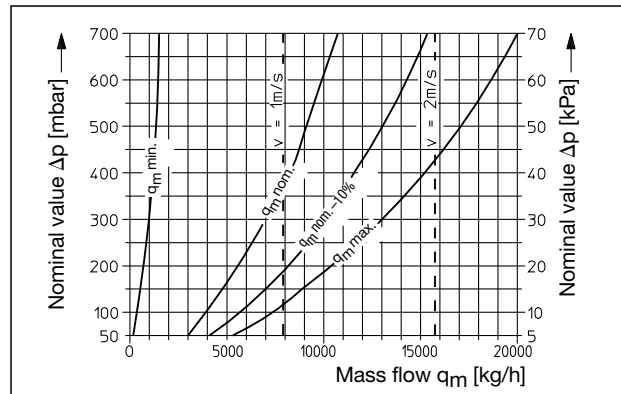

DN 50: $k_{vs} = 34.0$

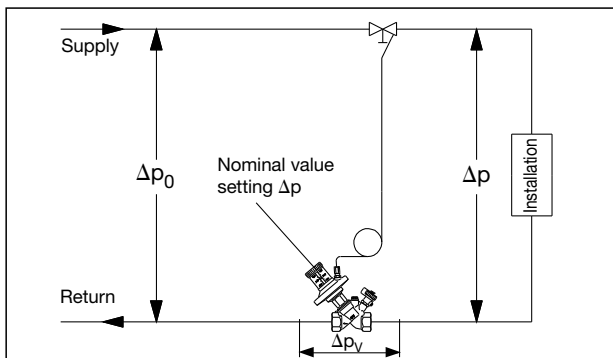

System illustration

The recommended application range is determined by the minimum flow rate ($q_{m,min.}$) and the maximum flow rate ($q_{m,max.}$). Design of the regulator can be carried out with the help of the charts illustrated above. Depending on the flow rate and the differential pressure, the suitable regulator can be determined. The maximum flow rate of the installation to be expected may not exceed the flow rate of the regulator ($q_{m,max.}$). As for the curve $q_{m,nom.}$, the differential pressure of the installation corresponds to the set nominal value.

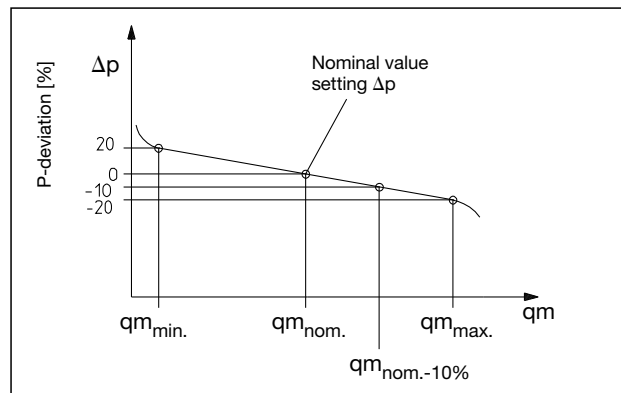

Smallest p-deviation with average nominal setting ($q_{m,nom.}$).

The curve $q_{m,nom.} - 10\%$ shows the values with a p-deviation of 10%.

The charts are valid for the condition $\Delta p_0 \geq 2 \times \Delta p$.

To guarantee a sufficient flow authority of the differential pressure regulator, Δp_0 should be $\Delta p_0 \geq 1.5 \times \Delta p$.

Note: Operation of the differential pressure regulator is guaranteed even below this value.

Examples of installation:

“Hydromat DTR” / “Hydrocontrol ATR”

Setting and automatic regulation of the differential pressure in a riser.

Condition:

Calculation of the mass flow and the corresponding differential pressure in the riser which shall be regulated.

Note:

Simple setting of the required nominal value by turning the handwheel.

(Illustrated isolating valve is not required for hydronic balancing.)



“Hydromat QTR” / “Hydromat DTR”

Setting and automating regulation of the flow rate and the differential pressure in a riser.

Condition:

Calculation must have been carried out (i.e. total mass flow of the riser which shall be regulated must be known to find out the correct size of the valve)

Note:

Simple setting of the nominal values at the handwheel of the flow and differential pressure regulator.

OVENTROP GmbH & Co. KG
 Paul-Oventrop-Straße 1
 D-59939 Olsberg
 Germany
 Telephone +49(0) 2962 82-0
 Fax +49(0) 2962 82-450
 E-Mail mail@oventrop.de
 Internet www.oventrop.de

Subject to technical modification without notice.

Product range 3
 ti 96-EN/10/MW
 Edition 2015

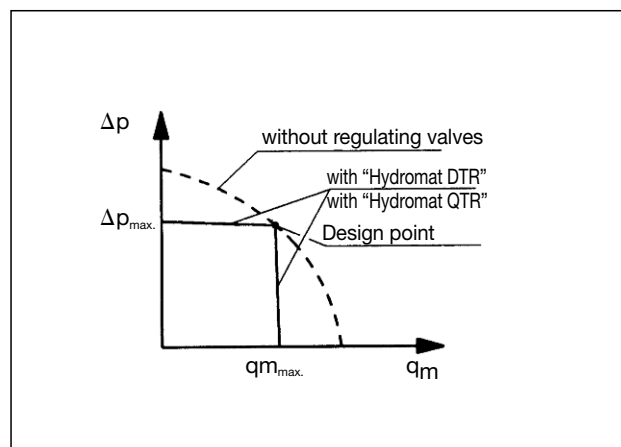
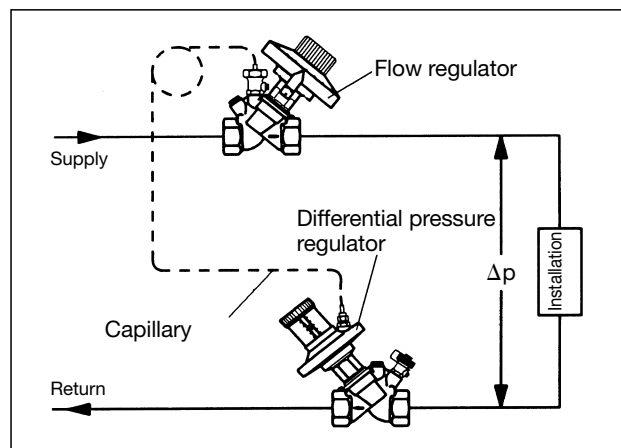
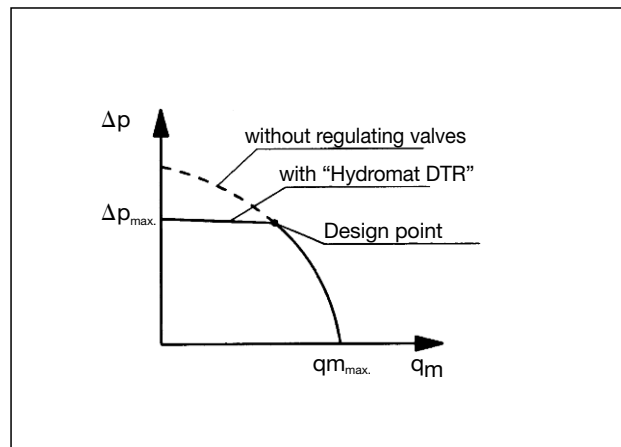
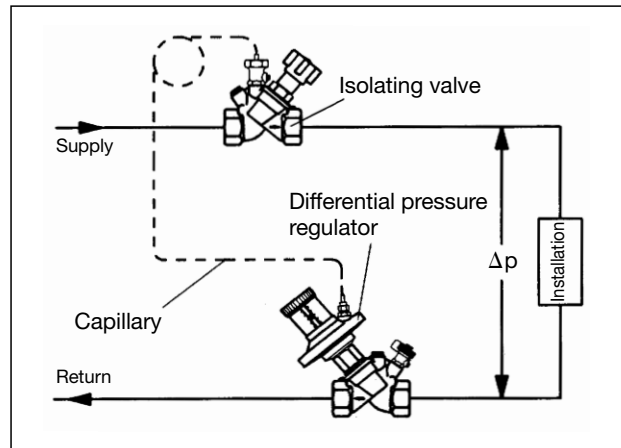

For an overview of our global presence visit www.oventrop.de