

# INSTRUCTIONS FOR INSTALLERS

---

## **Oventrop REGTRONIC PX**

### **Important!**

Please read the instructions carefully before installing and operating the unit!

Failure to do this can void product warranty!  
Please keep the instructions in a safe place!

This unit described has been manufactured and inspected according to CE regulations.



	<p>Parameters set using the System Settings menu should only be configured or modified by installers or qualified technical personnel. Setting the wrong parameters can compromise the functionality of the control unit and solar system</p>
---	---

**Table of contents:**

<b>1</b>	<b>"SYSTEM SETTINGS" MENU"/ CHANGES TO THE SYSTEM .....</b>	<b>3</b>
<b>2</b>	<b>USING A DATASTICK® .....</b>	<b>4</b>
2.1	FACTORY SETTINGS .....	4
2.1.1	<i>Restoring factory settings .....</i>	<i>4</i>
2.1.2	<i>Saving/loading configuration parameters.....</i>	<i>4</i>
2.2	UPDATING SYSTEM SOFTWARE.....	4



# 1 "SYSTEM SETTINGS" MENU"/ CHANGES TO THE SYSTEM

During normal operation, the "System Settings" menu only displays parameters and does not allow them to be altered. This prevents accidental changes. **To change parameters, this menu must be selected within one minute of switching on the unit.**

While the system is running, changes can be made using the System Settings menu by pressing the top , bottom  and right-hand  button simultaneously.

Once the user is in the menu, no time limits apply.

**the unit has been switched on and one minute after the user has exited the menu.**

The System Settings menu is used to select the basic schema and the language, and also to activate or deactivate the available protective and ancillary features. The buttons  and  are used to page through the various submenus. The status – e.g. "On" or "Off" – is also shown next to the name of each submenu. Submenus are selected by using the  button.

**The System Settings menu "locks" itself automatically one minute after**

Allocation of layout no. to system number: X1010 = 3301, X1020 = 3302, X1030 = 3303, X2010 = 3304, X2020 = 3305, X2030 = 3306.

Note: 3300 is the initial software set!

**Example:** change system 3300 to 3301

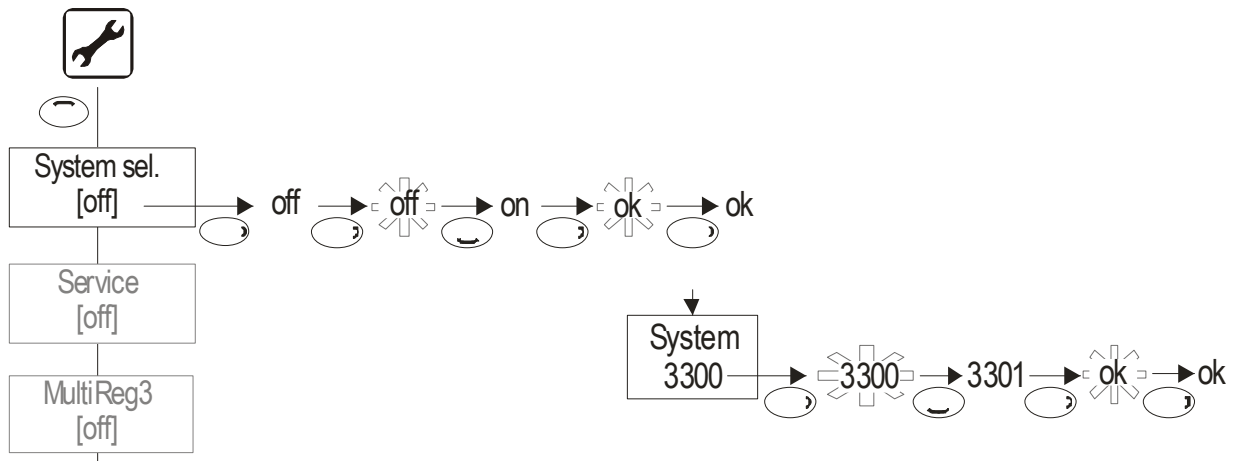

## 2 USING A DATASTICK®

An installer or technician can use a DataStick® for the following tasks:

- Updating unit parameters
- Saving/loading factory settings
- Updating system software

### **2.1 Factory settings**

Factory settings can be saved, loaded or restored in the "System Settings" menu.

This also makes it possible to transfer configuration data from one control unit to another, for example.

#### **2.1.1 Restoring factory settings**

**Menu item "Factory settings":**

- Off
- On: Restores the default factory settings

#### **2.1.2 Saving/loading configuration parameters**

**Menu item "Factory settings" Parameters:**

Only insert or remove the DataStick® at this menu. If the DataStick® has been previously used as a programming stick, then other menus in the system will ask the user if the software on the DataStick® should be loaded! Parameter backups on the stick will not have this effect.

- Off
- Save
- Stick available: Message "OK"
  - Stick unavailable: Message "OK" (the data will be sent, although it cannot be stored)
- Load
  - Stick available, system no. and system version on the stick match the data in the control unit: Message "OK"
  - Stick available, system no. on the stick matches the data in the control unit, but the version is different: Message "Chk. par." : the installer needs to check and verify the parameters.
  - System no. does not match the system no. in the control unit: Message "Error"

### **2.2 Updating system software**

First, insert the DataStick. If the DataStick contains a software package that is valid for this unit, then the screen will display "Copy DataStick start?". Press the "OK" button twice to

confirm, and the copy process will start. Once copying has finished, the unit will ask you to remove the DataStick. The control unit will then reboot.