

EN



11207512

Please read this manual carefully to get the best performance from this unit.
Please keep this manual carefully.

Safety advice

Please pay attention to the following safety advice in order to avoid danger and damage to people and property.

Instructions

Attention must be paid to the valid local standards, regulations and directives!

Information about the product

Proper usage

The solar controller is designed for electronically controlling standard solar thermal systems and heating systems in compliance with the technical data specified in this manual.

Improper use excludes all liability claims.

CE-Declaration of conformity

The product complies with the relevant directives and is therefore labelled with the CE mark. The Declaration of Conformity is available upon request, please contact the manufacturer.



Note

Strong electromagnetic fields can impair the function of the controller.

→ Make sure the controller as well as the system are not exposed to strong electromagnetic fields.

Subject to technical change. Errors excepted.

Target group

These instructions are exclusively addressed to authorised skilled personnel. Only qualified electricians are allowed to carry out electrical works. Initial commissioning must be effected by the system installer or qualified personnel named by the system installer.

Description of symbols

WARNING!

Warnings are indicated with a warning triangle!



→ **They contain information on how to avoid the danger described.**

Signal words describe the danger that may occur, when it is not avoided.

- **WARNING** means that injury, possibly life-threatening injury, can occur.
- **ATTENTION** means that damage to the appliance can occur.



Note

Notes are indicated with an information symbol.

→ Arrows indicate instruction steps that should be carried out.

Disposal

- Dispose of the packaging in an environmentally sound manner.
- Dispose of old appliances in an environmentally sound manner. Upon request we will take back your old appliances bought from us and guarantee an environmentally sound disposal of the devices.

Regtronic RC solar controller

The Regtronic RC is optimised for small and medium-sized solar thermal and heating systems, 10 pre-configured basic systems are available. The Regtronic RC is also the first controller of its category to offer the automatic function control according to the VDI 2169 directive.

Additionally, it is equipped with a potential-free extra-low voltage relay for after-heating demand and a V40 input for heat quantity measurement.

Contents

1	Overview	4	4	System-Monitoring-Display	20
2	Installation	5	4.1	System screen	21
2.1	Mounting	5	4.2	Further indications	21
2.2	Electrical connection	5	5	Status level / Measurement values	22
2.3	Data communication / Bus	6	6	Balance values	22
2.4	System overview	7	7	Commissioning	23
2.5	Systems	8	8	Indications, functions and options	25
3	Operation and function	18	8.1	Status level	25
3.1	Buttons and adjustment dial	18	8.2	Menu overview	29
3.2	Microbuttons for manual mode and holiday mode	18	9	User code and short menu – Adjustment values	50
3.3	Control lamp	19	10	Messages	50
3.4	Menu structure	19	11	Troubleshooting	51
3.5	Selecting menu points and adjusting values	19	12	Index	54
3.6	Resetting balance values	20			

1 Overview

- 3 relay outputs (incl. 1 extra-low voltage relay)
- 4 inputs for Pt1000, Pt500 or KTY temperature sensors
- 1 V40 impulse input
- 2 PWM outputs for speed control of high-efficiency pumps
- 10 basic systems to choose from
- Automatic function control according to VDI 2169

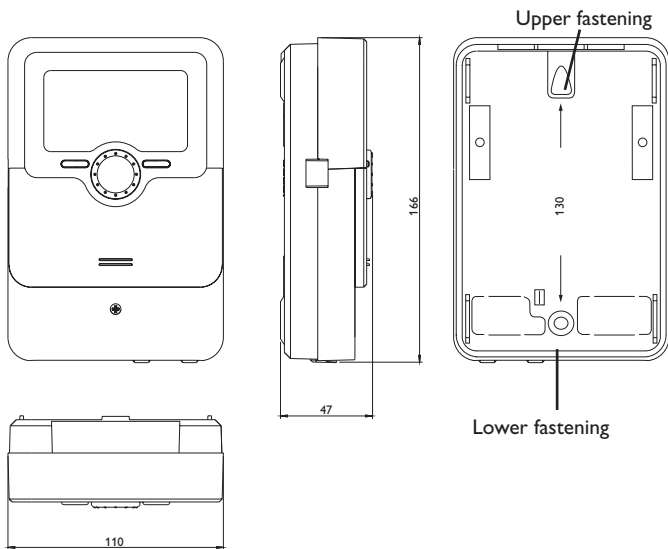

Technical data

Inputs: 4 inputs for Pt1000, Pt500 or KTY temperature sensors, 1 V40 impulse input

Outputs: 2 semiconductor relays, 1 potential-free extra-low voltage relay, 2 PWM outputs

PWM frequency: 1000 Hz

PWM voltage: 10.5 V

Switching capacity:

1 (1) A 240 V~ (semiconductor relay)

1 (1) A 30 V — (potential-free relay)

Total switching capacity: 2 A 240 V~

Fuse: T2A

Power supply: 100 ... 240 V~ (50 ... 60 Hz)

Supply connection: type Y attachment

Power consumption < 1 W (standby)

Mode of operation: type 1.B.C.Y action

Rated impulse voltage: 2.5 kV

Data interface: S-Bus

S-Bus current supply: 60 mA

Functions: operating hours counter, tube collector function, thermostat function, pump speed control, heat quantity measurement, adjustable system parameters and optional functions (menu-driven), balance and diagnostics function, function control according to VDI 2169

Housing: plastic, PC-ABS and PMMA

Mounting: wall mounting, also suitable for mounting into patch panels

Indication/Display: System-Monitoring-Display, for visualisation of the systems, 16-segment-display, 8 symbols for indication of the system status, control lamp (Lightwheel®) and background illumination

Operation: 4 push buttons at the front and 1 adjustment dial (Lightwheel®)

Protection type: IP 20 / DIN EN 60529

Protection class: I

Ambient temperature: 0 ... 40 °C

Degree of pollution: 2

Dimensions: 110 x 166 x 47 mm

2 Installation

2.1 Mounting

WARNING! Electric shock!



Upon opening the housing, live parts are exposed!
→ **Always disconnect the device from power supply before opening the housing!**



Note

Strong electromagnetic fields can impair the function of the controller.
→ Make sure the controller as well as the system are not exposed to strong electromagnetic fields.

The unit must only be located in dry interior rooms.

The controller must additionally be supplied from a double pole switch with contact gap of at least 3 mm.

Please pay attention to separate routing of sensor cables and mains cables.

In order to mount the device to the wall, carry out the following steps:

- Unscrew the crosshead screw from the cover and remove it along with the cover from the housing.
- Mark the upper fastening point on the wall. Drill and fasten the enclosed wall plug and screw leaving the head protruding.
- Hang the housing from the upper fastening point and mark the lower fastening point (centres 130mm).
- Insert lower wall plug.
- Fasten the housing to the wall with the lower fastening screw and tighten.
- Carry out the electrical wiring in accordance with the terminal allocation (see page 5).
- Put the cover on the housing.
- Attach with the fastening screw.

2.2 Electrical connection

ATTENTION! ESD damage!



Electrostatic discharge can lead to damage to electronic components!

→ **Take care to discharge properly before touching the inside of the device! To do so, touch a grounded surface such as a radiator or tap!**

WARNING! Electric shock!



Upon opening the housing, live parts are exposed!

→ **Always disconnect the device from power supply before opening the housing!**



Note

Connecting the device to the power supply must always be the last step of the installation!



Note

The pump speed must be set to 100% when auxiliary relays or valves are connected.

The controller is supplied with power via a mains cable. The power supply of the device must be 100 ... 240 V~ (50 ... 60 Hz).

The controller is equipped with 3 relays in total to which loads such as pumps, valves, etc. can be connected:

- Relays 1 ... 2 are semiconductor relays, designed for pump speed control.
Conductor R1 ... R2
Neutral conductor N
Protective conductor ⊕
- Relay 4 is a potential-free low voltage relay



Note

The terminal R3 has no function!

Depending on the product version, mains cables and sensor cables are already connected to the device. If that is not the case, please proceed as follows:

Connect the **temperature sensors** (S1 to S5) to the corresponding terminals with either polarity:

- S1 = Sensor 1 (collector sensor)
- S2 = Sensor 2 (store sensor base)
- S3 = Sensor 3 (e. g. store sensor store 2)
- S4 = Sensor 4 (e. g. store sensor store 2)

A flow rate sensor can be connected to the terminals V40 and GND (either polarity).

The terminals marked **PWM** are control outputs for a high-efficiency pump (see page 18).

Relay allocation for PWM outputs:

PWMA - Relay 1

PWMB - Relay 2

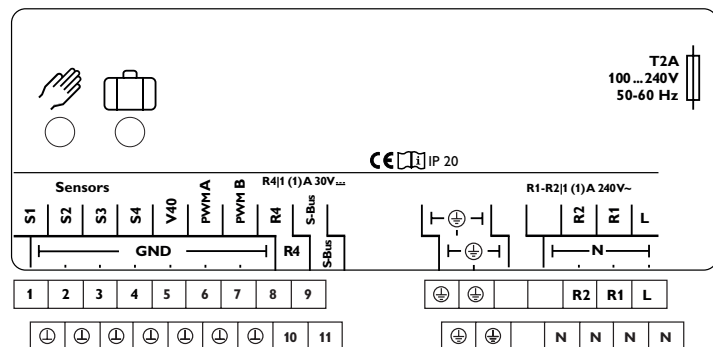

The **mains connection** is to be made at the following terminals:

Neutral conductor N

Conductor L

Protective conductor \oplus



Note

The connection depends on the system layout selected (see page 7).



Note

For more details about the commissioning procedure see page 23.

2.3 Data communication/Bus

The controller is equipped with an **S-Bus** for data transfer and energy supply to external modules. The connection is to be carried out at the terminals marked **S-Bus** (either polarity).

One or more **S-Bus** modules can be connected via this data bus, such as:

- Datalog CS-BS-1
- Datalog CS-BS -6

2.4 System overview

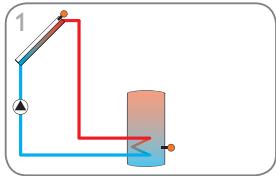

Solar system with 1 store (page 8)

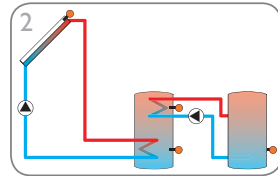

Solar system with 2 stores and heat exchange (page 9)

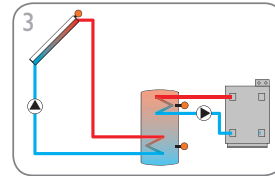

Solar system with 1 store and afterheating (page 10)

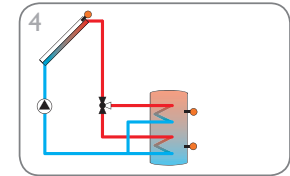

Solar system with 1 store and 3-port valve for store loading in layers (page 11)

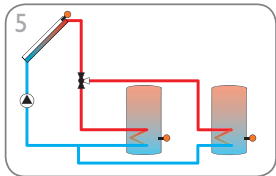

Solar system with 2 stores and valve control (page 12)

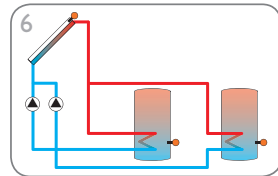

Solar system with 2 stores and pump control (page 14)

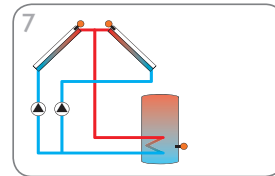

Solar system with east-/west collectors (page 14)

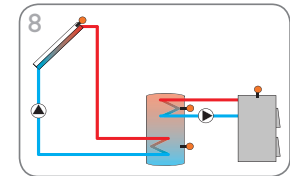

Solar system with 1 store and solid fuel boiler (page 15)

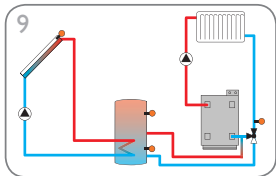

Solar system with 1 store and return preheating (page 16)

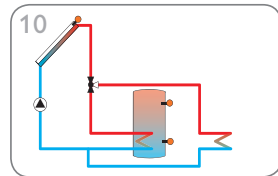

Solar system with 1 store and heat dump (page 17)

2.5 Systems

System 1: Standard solar system with 1 store

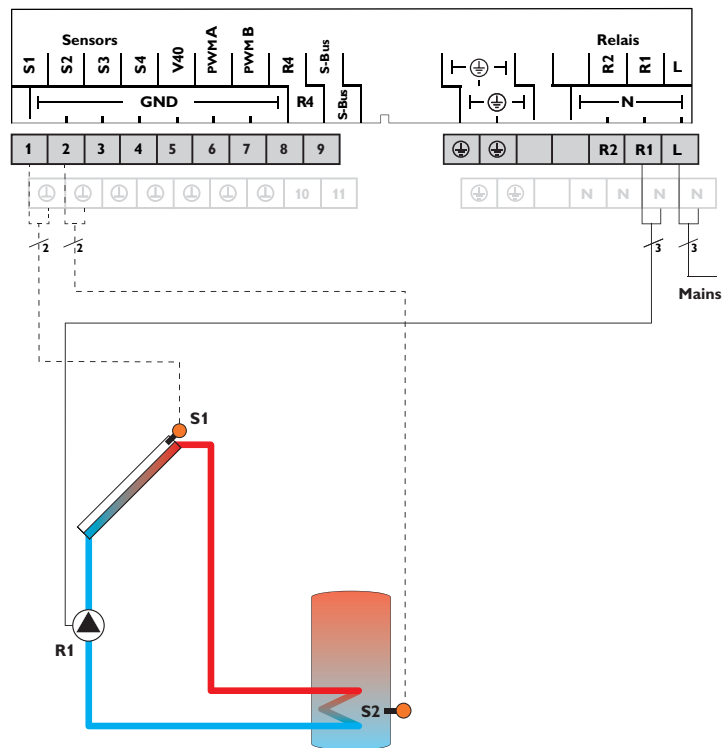

Sensors		
S1	Temperature collector	1/GND
S2	Temperature store base	2/GND
S3	Free	3/GND
S4	Free	4/GND

Relay		
R1	Solar pump	R1/N/PE
R2	Free	R2/N/PE
R4	Free	R4/R4

The controller calculates the temperature difference between collector sensor S1 and store sensor S2. If the difference is larger than or identical to the adjusted switch-on temperature difference, the pump (R1) will be switched on and the store will be loaded until the switch-off temperature difference or the maximum store temperature is reached.

System 1 system screen

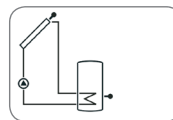

System 2: Solar system with 2 stores and heat exchange

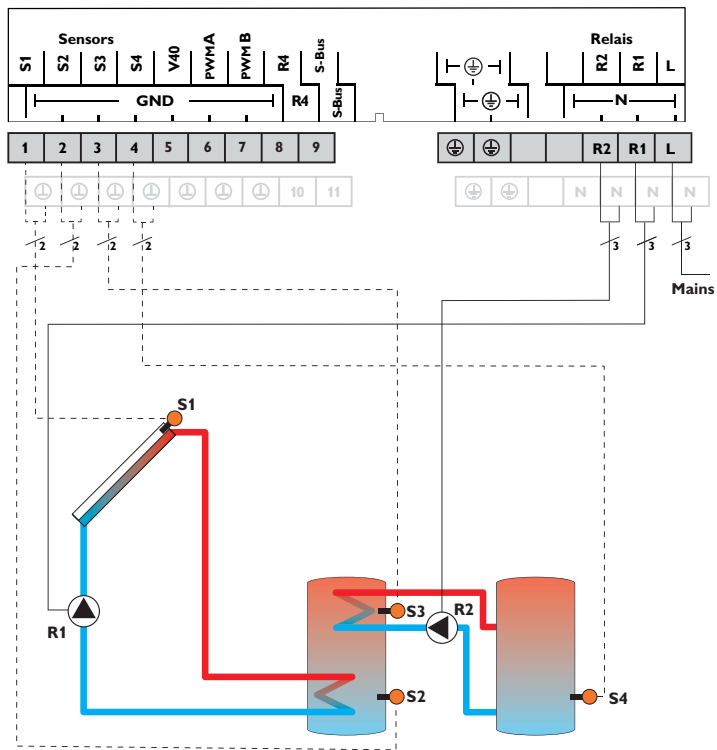

Sensors		
S1	Temperature collector	1/GND
S2	Temperature store base	2/GND
S3	Temperature heat exchange source	3/GND
S4	Temperature heat exchange sink	4/GND

Relay		
R1	Solar pump	R1/N/PE
R2	Store loading pump	R2/N/PE
R4	Free	R4/R4

The controller calculates the temperature difference between collector sensor S1 and store sensor S2. If the difference is larger than or identical to the adjusted switch-on temperature difference, the pump (R1) will be switched on and the store will be loaded until the switch-off temperature difference or the maximum store temperature is reached.

Heat exchange control to an existent store via an additional pump (R2) can be carried out with another temperature differential function (S3 heat source/S4 heat sink).

System 2 system screen

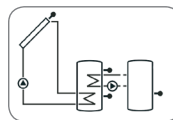

System 3: Solar system with 1 store and afterheating

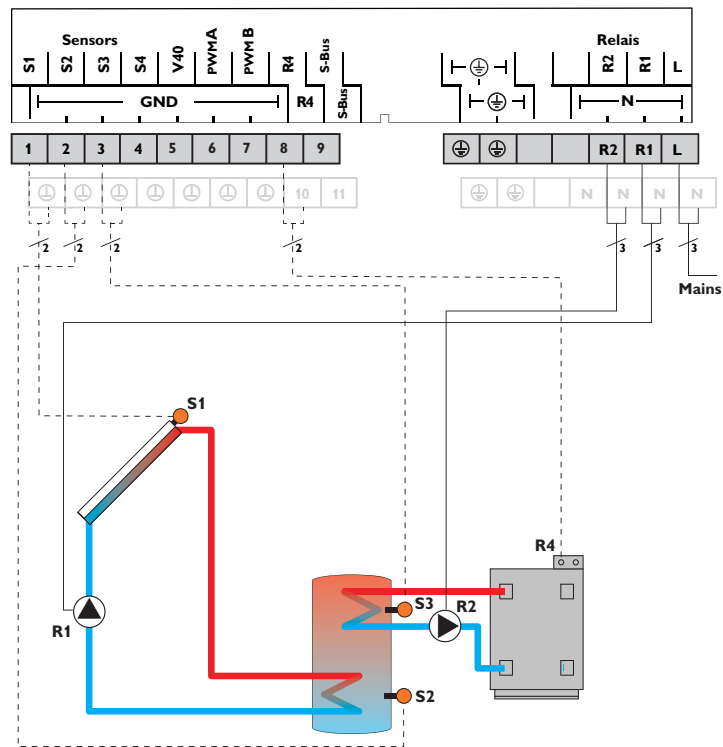

Sensors		
S1	Temperature collector	1/GND
S2	Temperature store base	2/GND
S3	Temperature afterheating	3/GND
S4	Free	4/GND

Relay		
R1	Solar pump	R1/N/PE
R2	Store loading pump	R2/N/PE
R4	Afterheating demand	R4/R4

The controller calculates the temperature difference between collector sensor S1 and store sensor S2. If the difference is larger than or identical to the adjusted switch-on temperature difference, the pump (R1) will be switched on and the store will be loaded until the switch-off temperature difference or the maximum store temperature is reached.

Afterheating (R2 and R4) can be carried out with a thermostat function (S3). If the value at S3 reaches the switch-on temperature for the afterheating, the relay is switched on. If the value exceeds the switch-off temperature for the afterheating, the relay is switched off again.

System 3 system screen

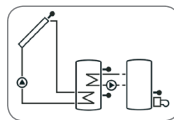

System 4: Solar system with 1 store and 3-port valve for store loading in layers

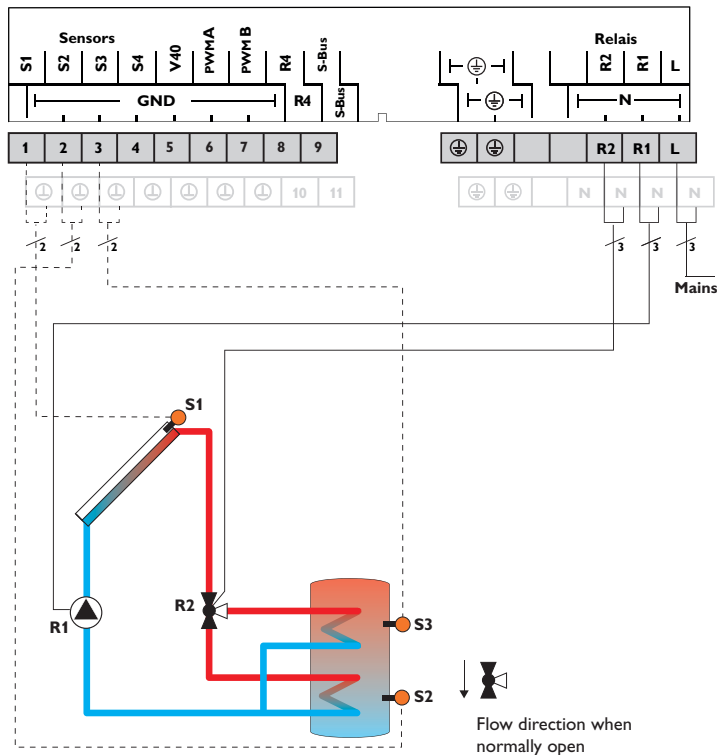

Sensors	
S1	Temperature collector 1/GND
S2	Temperature store base 2/GND
S3	Temperature store top 3/GND
S4	Free 4/GND

Relay		
R1	Solar pump	R1/N/PE
R2	Valve Solar	R2/N/PE
R4	Free	R4/R4

The controller compares the temperature at sensor S1 to the temperatures at sensors S2 and S3. If the measured temperature differences are higher than the adjusted switch-on temperature differences, the pump (R1) will be activated and the corresponding store zone will be loaded up to the adjusted store maximum or set temperature respectively via the valve (R2). The priority logic effects prior loading of the upper zone of the store.

System 4 system screen

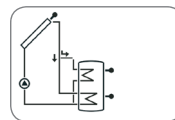

System 5: 2-store system with valve logic, 1 pump, 3 sensors and 3-port valve

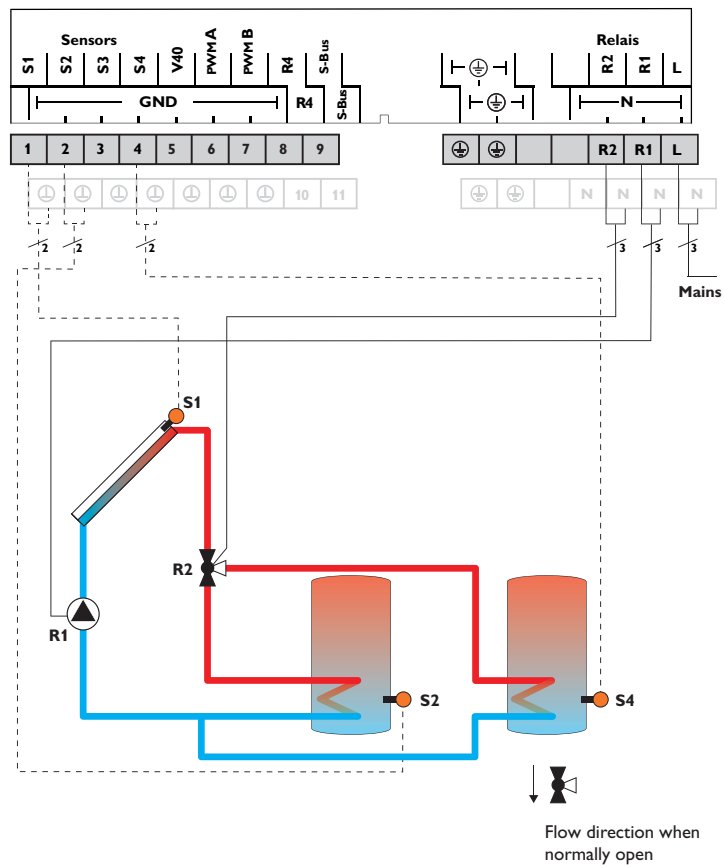

Sensors	
S1	Temperature collector 1/GND
S2	Temperature store base 2/GND
S3	Free 3/GND
S4	Temperature store 2 base 4/GND

Relay		
R1	Solar pump	R1/N/PE
R2	Valve Solar	R2/N/PE
R4	Free	R4/R4

The controller compares the temperature at sensor S1 to the temperatures at sensors S2 and S4. If the measured temperature differences are higher than the adjusted switch-on temperature differences, the pump (R1) will be activated and the corresponding store will be loaded up to the adjusted store maximum or set temperature respectively via the valve (R2). The priority logic effects prior loading of store 1.

System 5 system screen

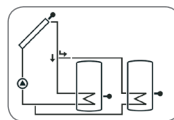

Flow direction when normally open

System 6: 2-store solar system with pump logic

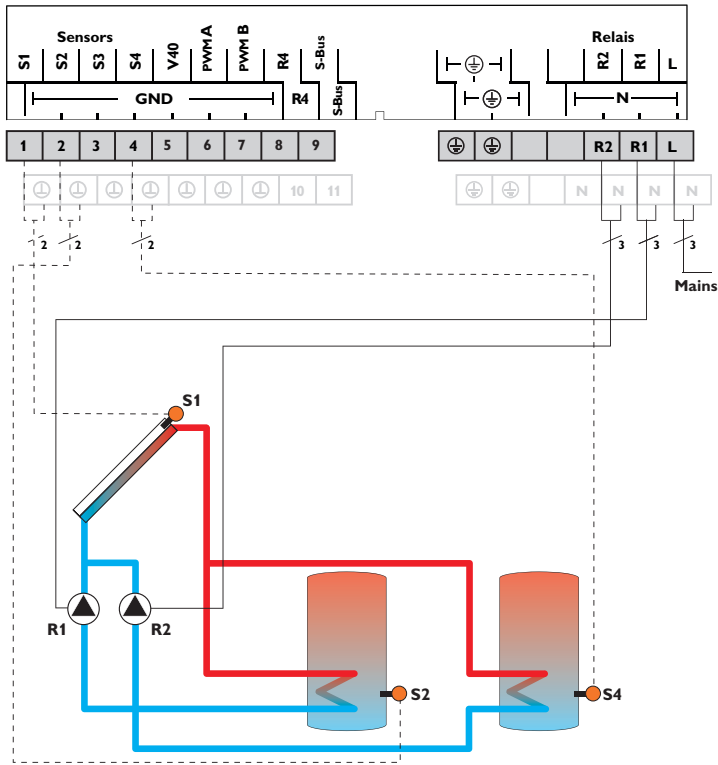

Sensors		
S1	Temperature collector	1/GND
S2	Temperature store base	2/GND
S3	Free	3/GND
S4	Temperature store 2 base	4/GND

Relay		
R1	Solar pump store	R1/N/PE
R2	Solar pump store 2	R2/N/PE
R4	Free	R4/R4

The controller compares the temperature at sensor S1 to the temperatures at sensors S2 and S4. If the measured temperature differences are higher than the adjusted switch-on temperature differences, the pump (R1 and/or R2) will be activated and the corresponding store will be loaded up to the adjusted store maximum or set temperature respectively at most. The priority logic effects prior loading of store 1.

System 6 system screen

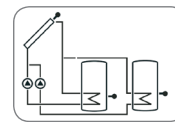

System 7: Solar system with east-/ west collectors

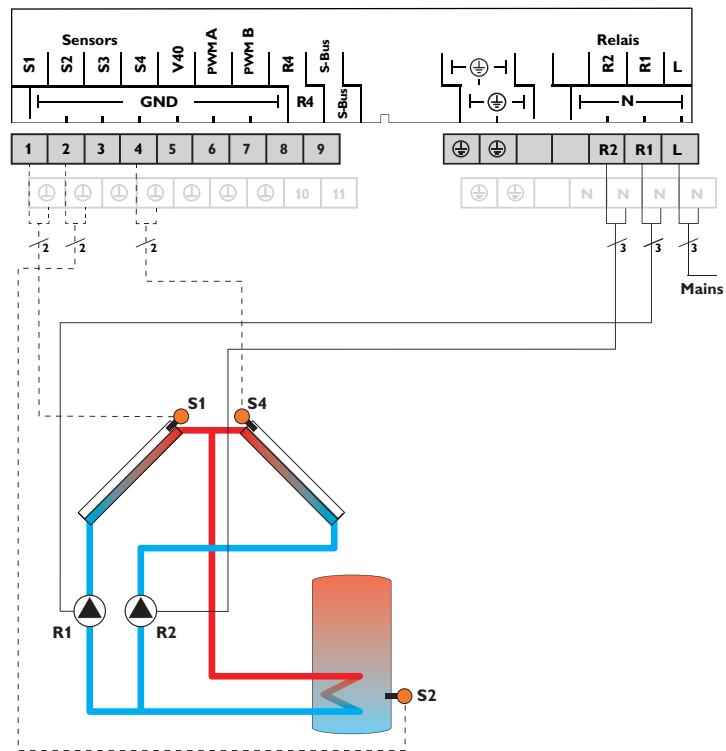

Sensors		
S1	Temperature collector	1/GND
S2	Temperature store base	2/GND
S3	Free	3/GND
S4	Temperature collector 2	4/GND

Relay		
R1	Solar pump collector	R1/N/PE
R2	Solar pump collector 2	R2/N/PE
R4	Free	R4/R4

The controller compares the temperatures at the collector sensors S1 and S4 to the store temperature at sensor S2. If one of the measured temperature difference is higher than the adjusted switch-on temperature difference, the corresponding pump (R1 and/or R2) will be switched on, thus loading the store until either the switch-off temperature difference or the store maximum temperature is reached.

System 7 system screen

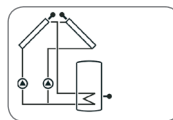

System 8: Solar system with 1 store and afterheating with solid fuel boiler

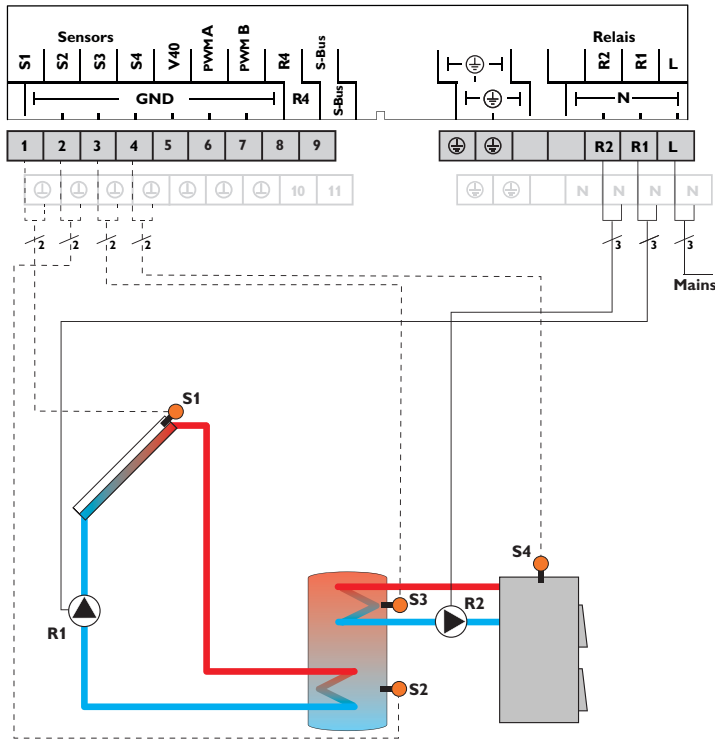

Sensors		
S1	Temperature collector	1/GND
S2	Temperature store base	2/GND
S3	Temperature store top	3/GND
S4	Temperature solid fuel boiler	4/GND

Relay		
R1	Solar pump	R1/N/PE
R2	Loading pump solid fuel boiler	R2/N/PE
R4	Free	R4/R4

The controller calculates the temperature difference between collector sensor S1 and store sensor S2. If the difference is larger than or identical to the adjusted switch-on temperature difference, the pump (R1) will be switched on and the store will be loaded until the switch-off temperature difference or the maximum store temperature is reached.

With another temperature differential function (S4 heat source/S3 heat sink), afterheating of the store with a solid fuel boiler can be carried out via another pump (R2).

System 8 system screen

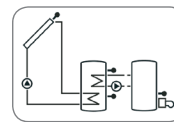

System 9: Solar system with 1 store and return preheating

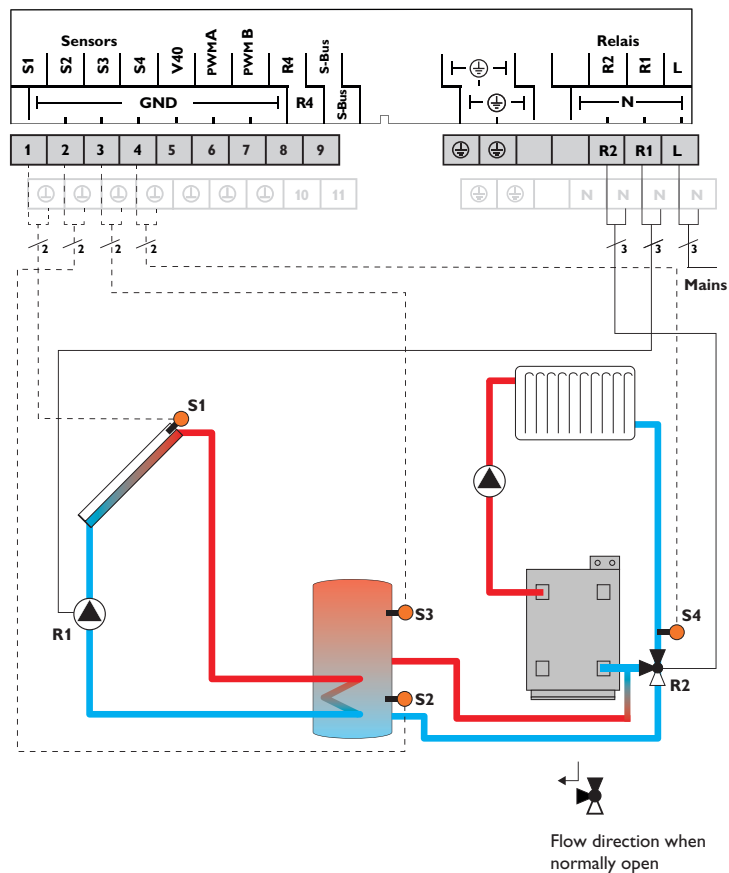

Flow direction when normally open

Sensors		
S1	Temperature collector	1/GND
S2	Temperature store base	2/GND
S3	Temperature store return preheating	3/GND
S4	Temperature heating return	4/GND

Relay		
R1	Solar pump	R1/N/PE
R2	Return preheating valve	R2/N/PE
R4	Free	R4/R4

The controller calculates the temperature difference between collector sensor S1 and store sensor S2. If the difference is larger than or identical to the adjusted switch-on temperature difference, the pump (R1) will be switched on and the store will be loaded until the switch-off temperature difference or the maximum store temperature is reached.

With another temperature differential function (S3 heat source/S4 heat sink) return preheating (heating circuit backup) is possible via another valve (R2).

System 9 system screen

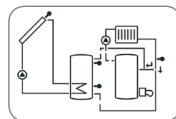

System 10: Solar system with 1 store and heat dump

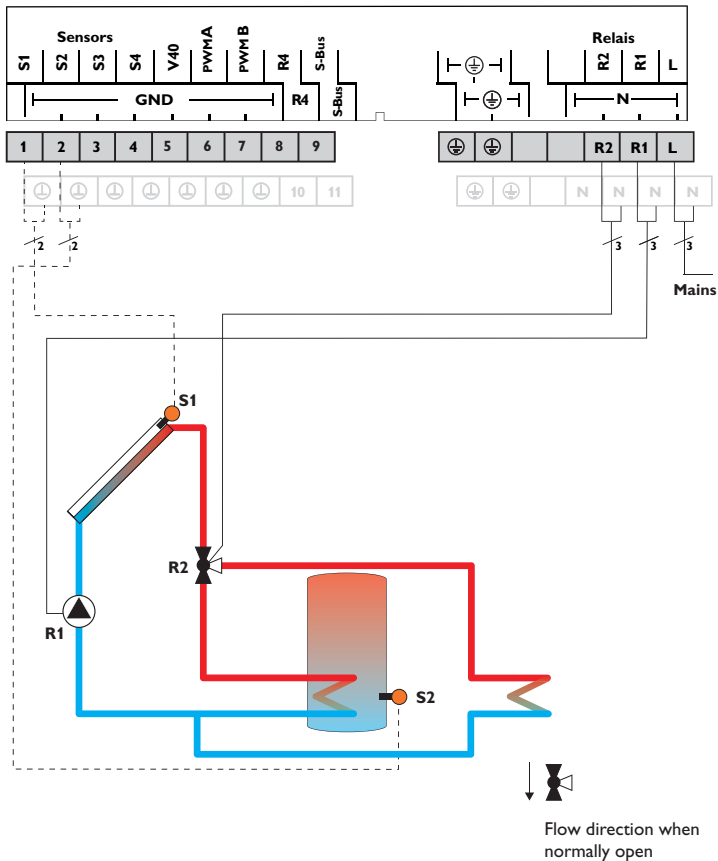

Sensors		
S1	Temperature collector	1/GND
S2	Temperature store base	2/GND
S3	Free	3/GND
S4	Free	4/GND

Relay		
R1	Solar pump	R1/N/PE
R2	Heat dump valve	R2/N/PE
R4	Free	R4/R4

The controller calculates the temperature difference between collector sensor S1 and store sensor S2. If the difference is larger than or identical to the adjusted switch-on temperature difference, the pump (R1) will be switched on and the store will be loaded until the switch-off temperature difference or the maximum store temperature is reached.

If the collector maximum temperature (C_{MAX}) is reached, the solar pump will be activated by R1 and the 3-port valve by R2 in order to divert excess heat to a heat sink. For safety reasons, excess heat dump will only take place as long as the store temperature is below the non-adjustable shutdown temperature of 95 °C [200 °F].

System 10 system screen

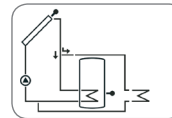

Electrical connection of a high-efficiency pump (HE pump)

Speed control of a HE pump is possible via a PWM signal. The pump has to be connected to the relay (power supply) as well as to one of the PWM A/B outputs of the controller.

Relay allocation for PWM outputs:

PWM A - Relay 1

PWM B - Relay 2

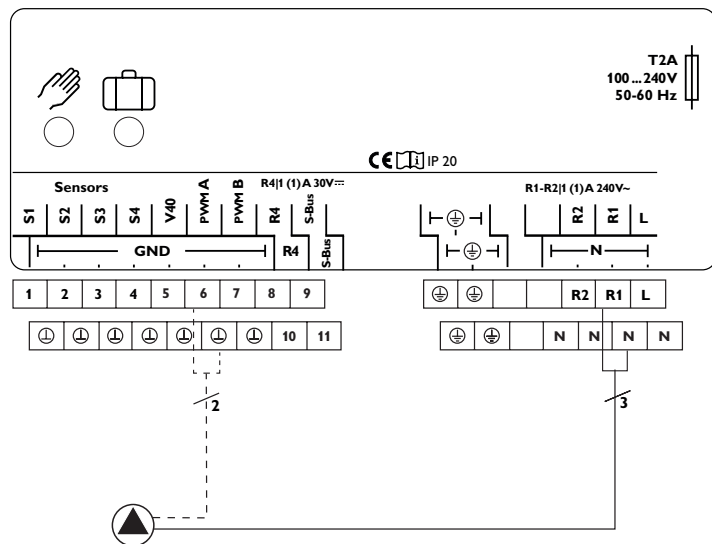

3 Operation and function

3.1 Buttons and adjustment dial

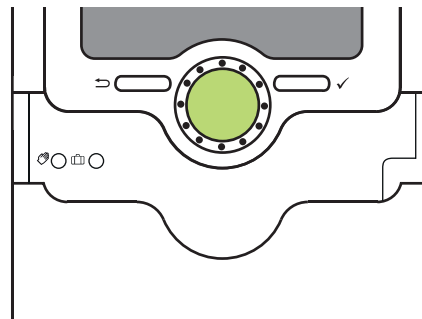

The controller is operated via 2 buttons and 1 adjustment dial (Lightwheel®) below the display:



Left button (↶) - escape button for changing into the previous menu



Right button (✓) - confirming/selecting

Lightwheel® - scrolling upwards/scrolling downwards, increasing adjustment values/reducing adjustment values

3.2 Microbuttons for manual mode and holiday mode





The controller is equipped with two microbuttons for quick access to the manual mode and the holiday function. The microbuttons are located underneath the slidable housing cover, the slider.

Microbutton : If the microbutton  is briefly pressed, the controller changes to the manual mode menu (see page 43).

Microbutton : The microbutton  is used for activating the holiday function (see page 42). If the microbutton is pressed and held down for approx. 3 s, the adjustment channel **DAYS** appears, allowing to enter the number of days for an absence. If the parameter is set to a value higher than 0, the function becomes active using the adjustments that have previously been made in the **H-DAY** menu. The days will be counted backwards at 00:00. If the value is set to 0, the function is deactivated.

3.3 Control lamp

The controller is equipped with a multicolour LED in the centre of the Lightwheel®, indicating the following states:

Colour	Permanently shown	Flashing
	Everything OK	Manual mode: at least one relay HAND ON/minimum speed/maximum speed
		Sensor line break, sensor short circuit, flow rate monitoring, overpressure, low pressure
	Holiday function active	ΔT too high, night circulation, FL/RE interchanged, store maximum temperature exceeded
		Manual mode: at least one relay HAND OFF

3.4 Menu structure

Status level

TCOL
TCOL2
TSTB
TSTT
...

Menu level

BALAN
Adjustment level
SYS
LOAD
COL
...

Balance values

h R1
h R2
MAXS1
MINS1
...

Configuration

DT O
DT F
DT S
S SET
S MAX
SMAXS
...

The menu structure of the controller consists of 2 levels: the status level and the menu level.

The status level consists of different display channels which indicate display values and messages.

The menu level consists of the balance values menu and several menu items each of which consists of sub-menus and adjustment channels. In order to activate or deactivate a function, it must be selected in the menu level. The display changes to the adjustment menu in which all adjustments required can be carried out.



Note

Some of the menu items depend on the selected system and the adjusted options. Therefore, they are only displayed if they are available.



Note

The abstract from the menu structure is for information on the structure of the controller menu and is therefore not complete.

3.5 Selecting menu points and adjusting values

During normal operation of the controller, the display shows the status level with the adjustment channels. If no button is pressed for 1 min, the display illumination goes out. If no button is pressed for further 3 min, the display indicates the status level.

Press any key to reactivate the display illumination.

In order to scroll through the display channels, turn the Lightwheel®.

Accessing the adjustment level:

→ Press the right button (✓) for approx. 3 s.

The display changes to the adjustment level. All menus contain adjustment channels and are marked with **PUSH** below the menu item.

→ In order to access the desired menu, press the right button (✓).



Note

Only if the installer code is entered (see page 50), will the adjustment level be accessible.

Selecting and adjusting options/functions

An option or function containing adjustment values are marked with **PUSH**.

➔ In order to access the sub-menu of the option, select the option by turning the Lightwheel® and press the right button (✓) .

➔ In order to activate an option, select ON. In order to deactivate it, select OFF.

The adjustment channels are characterised by the indication **SET**.

➔ Select the desired adjustment channel by turning the Lightwheel®.

➔ Confirm your selection with the right button (✓). **SET** starts flashing (adjustment mode).

➔ Adjust the value by turning the Lightwheel®.

➔ Confirm your selection with the right button (✓). **SET** permanently appears, the adjustment has been saved.

BACK PUSH appears as the last display.

➔ In order to get back to the menu selection, press the right button (✓).

If no button has been pressed within a couple of minutes, the adjustment is cancelled and the previous value is retained.

3.6 Resetting balance values

Heat quantity, operating hours of the relays as well as minimum and maximum temperatures can be set back to zero. In order to reset a value, proceed as follows:

➔ Select the desired value and press the right button(✓). **SET** starts flashing.

➔ Turn the Lightwheel® anticlockwise.

The value is set back to 0.

➔ Press the right button(✓).

The message DEL will be displayed.

➔ Turn the Lightwheel® clockwise.

YES instead of NO will be displayed.

➔ Confirm your selection with the right button (✓).

The value will be set back to zero and the symbol will be permanently displayed.

In order to interrupt this process, press the left button (↶).

4 System-Monitoring-Display

System-Monitoring-Display

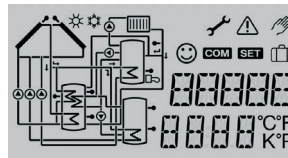

The System-Monitoring-Display consists of 3 blocks: channel display, tool bar and system screen.

Channel display



The channel display consists of 2 lines. The upper display line is an alphanumeric 16-segment display. In this line, mainly channel names and menu items are displayed. In the lower 16-segment display, values are displayed.

Tool bar

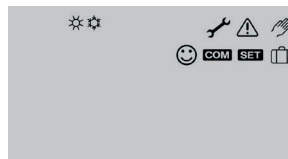

The additional symbols in the tool bar indicate the current system state.

4.1 System screen

The system selected is indicated in the System-Monitoring-Display. It consists of several system component symbols which are – depending on the current status of the system – either flashing, permanently shown or not indicated.

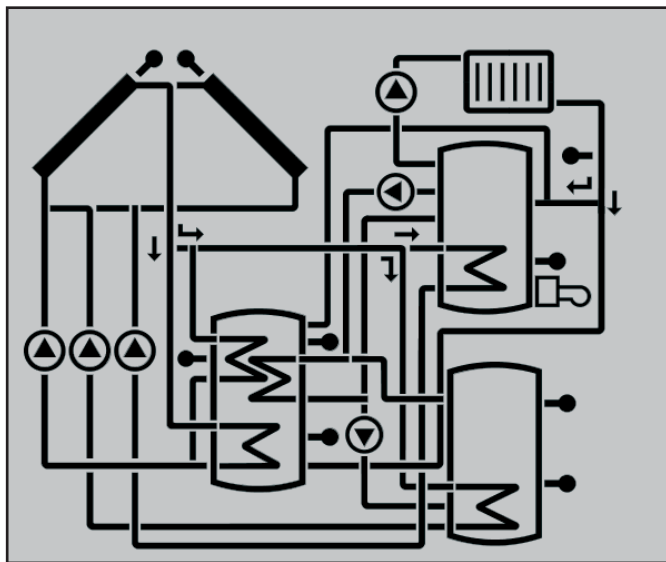

Collectors
with collector sensor

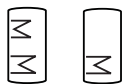

Store 1 and 2
with heat exchanger



3-port valves
Only the flow direction or current switching position is indicated.



Temperature sensor



Heating circuit
return preheating



Pump



Afterheating
with burner symbol

4.2 Further indications

Smiley

If the controller operates faultlessly (normal operation), a smiley ☺ is displayed.

Fault indication

If the controller detects a malfunction, the control LED flashes red and the symbols of the warning triangle ⚠ and the wrench 🔧 are additionally displayed.

Short text and ticker

Functions, options, measurement and balance values as well as messages are indicated as both short text and ticker. After the short text has been displayed, the corresponding long text will be indicated as a ticker from right to left.

Symbol	Permanently shown	Flashing
Status indications:		
☀	Store maximum limitation active (store maximum temperature has been exceeded)	Collector cooling function active, system cooling or store cooling active
☀	Antifreeze option activated	Collector temp. below minimum temp., antifreeze function active
⚠		Collector emergency shutdown active
⚠ + 🔧		Manual mode active
⚠ + ☀		Store emergency shutdown active
SET		Adjustment mode
🏠	Holiday function active	
☺	Normal operation	

Fault indication:

⚠ + 🔧	Sensor fault
-------	--------------

5 Status level/Measurement values

During normal operation of the controller, the display is in the status level, indicating the measurement values (depending on the system) shown in the table.

In addition to the display values, possible error messages are indicated in the status menu (see page 51).

Display	Description (long text)
TCOL	Temperature collector
TCOL2	Temperature collector 2
TSTB	Temperature store base
TSTT	Temperature store top
TST2B	Temperature store 2 base
TSTTS	Temperature heat exchange source
TST2S	Temperature heat exchange sink
TAH	Temperature afterheating
TSFB	Temperature solid fuel boiler
TSTSF	Temperature store - solid fuel boiler
TSTRP	Temperature store return preheating
TRET	Temperature heating circuit return
S3	Temperature sensor 3
S4	Temperature sensor 4
n1%	Speed relay 1
n2%	Speed relay 2
L/h	Flow rate sensor V40
TFHQM	Heat quantity measurement flow temperature
TRHQM	Heat quantity measurement return temperature
kWh	Heat quantity in kWh
MWh	Heat quantity in MWh
BLPR	Blocking protection relay 1
BLPR2	Blocking protection relay 2
INIT	Initialisation drainback
FLLT	Filling time drainback
STAB	Stabilisation drainback
TDIS	Disinfection temperature
CDIS	Countdown thermal disinfection
DDIS	Disinfection period
SDIS	Starting time delay
TIME	
DATE	
VERS	Software version

6 Balance values

The balance value menu indicates the balance values.

Display	Description
h R1	Operating hours relay 1
h R2	Operating hours relay 2
h R4	Operating hours relay 4
DAYS	Operating days of the controller (cannot be set back to zero)
MAXS1	Maximum temperature sensor 1
MINS1	Minimum temperature sensor 1
MAXS2	Maximum temperature sensor 2
MINS2	Minimum temperature sensor 2
MAXS3	Maximum temperature sensor 3
MINS3	Minimum temperature sensor 3
MAXS4	Maximum temperature sensor 4
MINS4	Minimum temperature sensor 4

7 Commissioning

When the hydraulic system is filled and ready for operation, connect the controller to the mains.

The controller runs an initialisation phase in which all symbols are indicated in the display. The Lightwheel® flashes red.

When the controller is commissioned or when it is reset, it will run a commissioning menu after the initialisation phase. The commissioning menu leads the user through the most important adjustment channels needed for operating the system.

Commissioning menu

The commissioning menu consists of the channels described in the following. In order to make an adjustment, press the right button (✓). **SET** starts flashing and the adjustment can be made. Confirm the adjustment with the right button (✓). Turn the Lightwheel®, the next channel will appear on the screen.

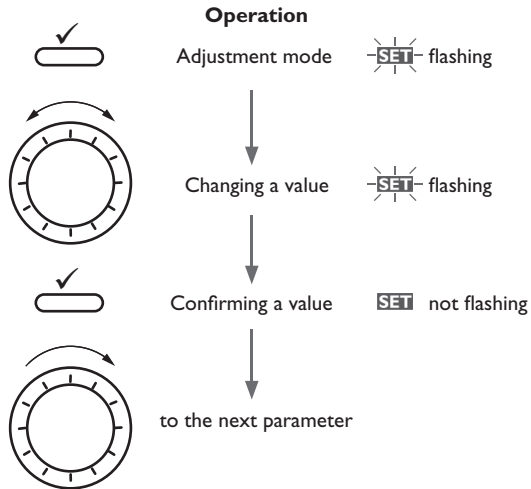

Commissioning

1. Language:

→ Adjust the desired menu language.

2. Time:

→ Adjust the clock time. First of all adjust the hours, then the minutes.

3. Daylight savings time adjustment:

→ Activate or deactivate the automatic daylight savings time adjustment.

4. Date:

→ Adjust the date. First of all adjust the year, then the month and then the day.

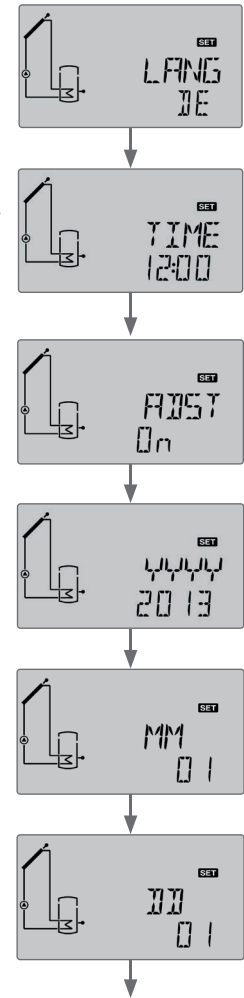

Commissioning

5. System:

→ Adjust the desired system (see page 30).

6. Store set temperature:

→ Adjust the desired store set temperature. In 2-store systems, the adjustment has to be carried out for **S2SET** as well (see page 31).

7. Maximum store temperature:

→ Adjust the maximum store temperature. In 2-store systems, the adjustment has to be carried out for **S2MAX** as well (see page 32).

8. Loading store 1:

→ Switch on or off the “loading store 1” option (see page 32).



Note

“Loading store 1” is only available if a 2-store system or store loading in layers has been previously selected in the sub-channel **SYS**.

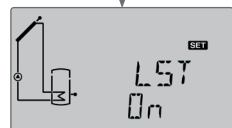
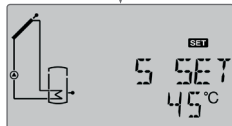
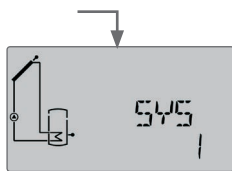

9. Loading store 2:

→ Switch on or off the “loading store 2” option (see page 32).



Note

“Loading store 2” is only available if a 2-store system or store loading in layers has been previously selected in the sub-channel **SYS**.

10. Relay control type:

→ Select the relay control type for **REL**. Carry out this adjustment for **REL2** as well, if necessary (see page 41).

11. Minimum speed:

→ Adjust the minimum speed **MIN** of the relay. Carry out this adjustment for relay 2 as well, if necessary (see page 41).



Note

The minimum speed value will not be available if **ONOF** has been selected in the sub-channel **REL (REL2)**.

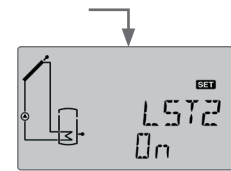

Commissioning

12. Maximum speed:

- Adjust the maximum speed **MAX** of the relay.
Carry out this adjustment for relay 2 as well, if necessary (see page 41).



Note

The maximum speed value will not be available if **ONOF** has been selected in the sub-channel **REL (REL2)**.

- **Complete the commissioning menu by pressing the right button (✓):**

The controller is then ready for operation and normally the

Factory settings will give close to optimum operation.



Note

The adjustments carried out during commissioning can be changed anytime in the corresponding adjustment channel. Additional functions and options can also be activated or deactivated.

Set the code to the customer code before handing over the controller to the customer (see page 50).

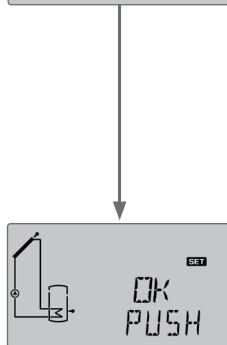
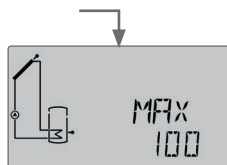

8 Indications, functions and options



Note

The values and adjustment channels as well as the adjustment ranges depend on the system selected, the functions and options as well as the user code entered and the system components connected to the controller.

8.1 Status level

Display of blocking protection time

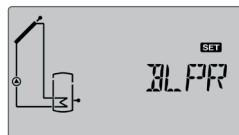

BLPR(2)

Blocking protection active

Display of drainback time periods

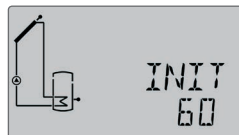

INIT

Initialisation active

Indicates the time adjusted in **tD_{TO}**, running backwards.



FLLT

Filling time active

Indicates the time adjusted in **tF_{LL}**, running backwards.



STAB

Stabilisation

Indicates the time adjusted in tSTB, running backwards.

Display of collector temperatures



TCOL(2)

Collector temperature

Display range: -40... +260 °C

Displays the current collector temperature.

- TCOL : Collector temperature
- TCOL2: Collector temperature 2 (2-collector system)

Display of store temperatures

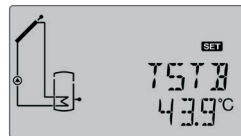

TSTB, etc.

Store temperatures

Display range: -40... +260 °C

Displays the current store temperature.

- TSTB : Store temperature base
 - TSTT : Store temperature top
- in 2-store systems (only if available):
- TST2T : Temperature store 2 top
 - TST2B : Temperature store 2 base
 - TSTTS : Temperature heat exchange source
 - TST2S : Temperature heat exchange sink
 - TSTS F : Temperature store - solid fuel boiler

Display of temperatures at S3 and S4

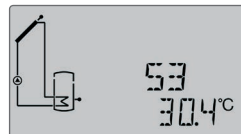

S3, S4

Temperature sensors

Display range: -40... +260 °C

Indicates the current temperature at the corresponding additional sensor (without control function).

- S3 : Temperature sensor 3
- S4 : Temperature sensor 4



Note

In systems with return preheating, S3 is used as the heat source sensor TSTR.

Display of further temperatures



T5FB, etc.

Further measured temperatures

Display range: -40 ... +260 °C

Indicates the current temperature at the corresponding sensor. The display of these temperatures depends on the system selected.

- TFSB : Temperature solid fuel boiler
- TRET : Temperature heating return
- TSTR : Temperature store return preheating
- TFHQM : Temperature flow (HQM)
- TRHQM : Temperature return (HQM)
- TAH : Temperature afterheating

Display of flow rate

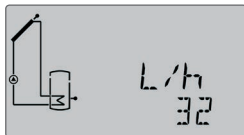

L/h

Flow rate

Display range: 0 ... 9999 l/h

Indicates the currently measured flow rate. This value is used for calculating the heat quantity supplied (V40).

Display of speed



n1%, *n2%*

Current pump speed

Display range: 20 ... 100 % (standard pump/HE pump)

Indicates the current speed of the corresponding pump.

Display of heat quantity



kWh/MWh

Heat quantity in kWh/MWh

Indicates the heat quantity produced in the system. For this purpose, the heat quantity measurement option has to be enabled. The flow rate as well as the values of the reference sensors flow and return are used for calculating the heat quantity supplied. It is shown in kWh in the **kWh** channel and in MWh in the **MWh** channel. The overall heat quantity results from the sum of both values.

The accumulated heat quantity can be set back to zero (see page 20).

Indication of thermal disinfection



TDIS

Disinfection temperature

Display range: -40 ... +260 °C

If the thermal disinfection option (**OTDIS**) is activated and the disinfection period is in progress, the disinfection temperature measured at the reference sensor is displayed in this channel.

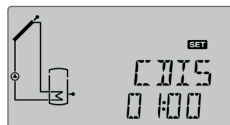

CDIS

Countdown monitoring period

Display range: 0 ... 30:0 ... 24 (dd:hh)

If the thermal disinfection option (**OTDIS**) is activated and the monitoring period is in progress, the remaining time of the monitoring period is displayed as **CDIS** (in hours and minutes), counting backwards.



SDIS

Starting time

Display range: 0:00 ... 24:00 (time)

If the thermal disinfection option (**OTDIS**) is activated and a starting delay time has been adjusted, the delay time is displayed (flashing) in this channel.



DDIS

Disinfection period

Display range: 0:00 ... 23:59 (hh:mm)

If the thermal disinfection option (**OTDIS**) is activated and the disinfection period is in progress, the remaining time of the heating period is displayed (in hours and minutes) in this channel, counting backwards.

Display of time

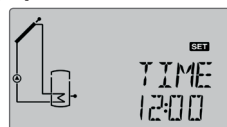

TIME

Time

Indicates the current clock time.

Display of date

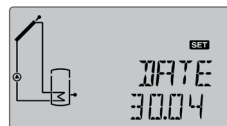

DATE

Date

Indicates the current date.

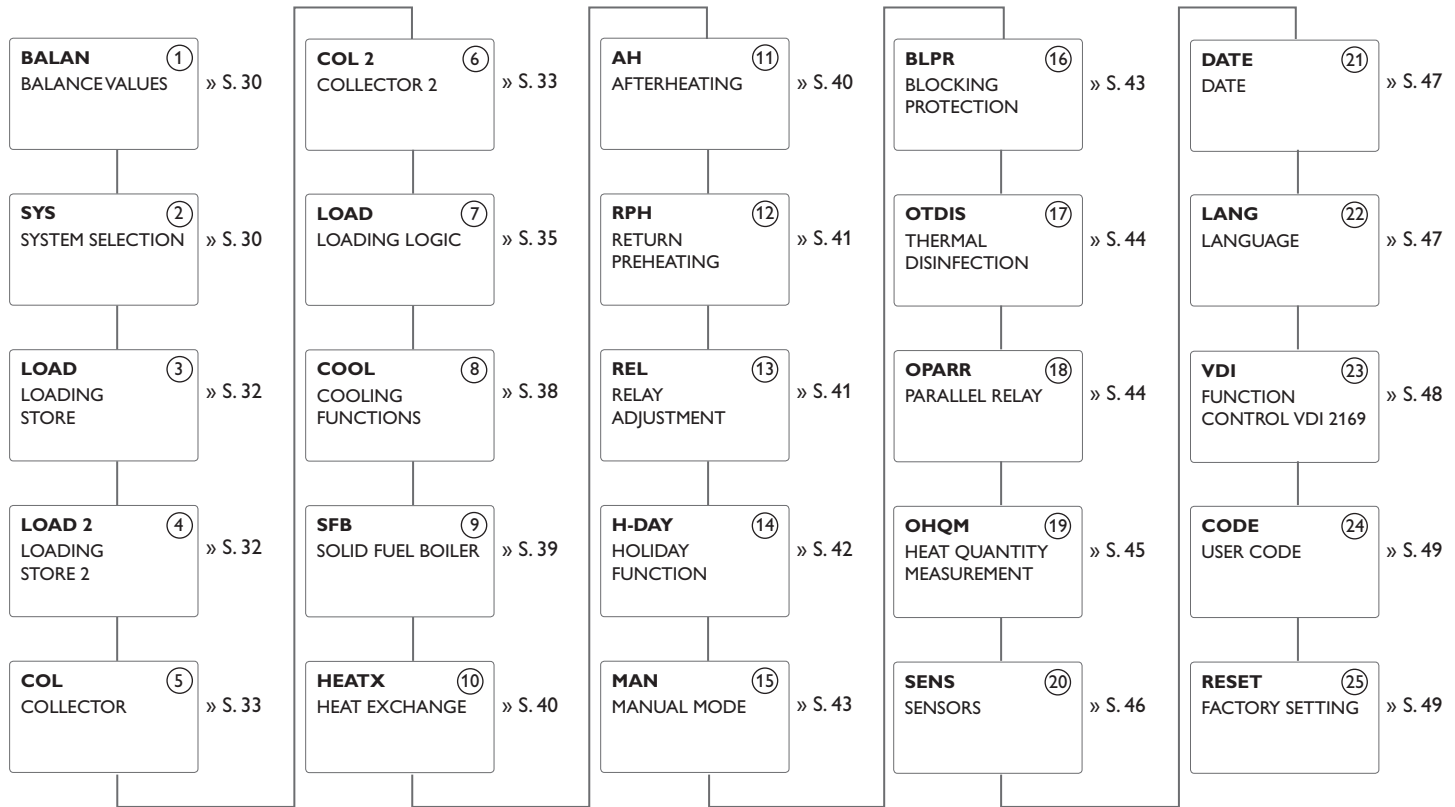

Parameters shown in the following with a dashed line depend on options and are only indicated if they are available in the system selected.

Balance values

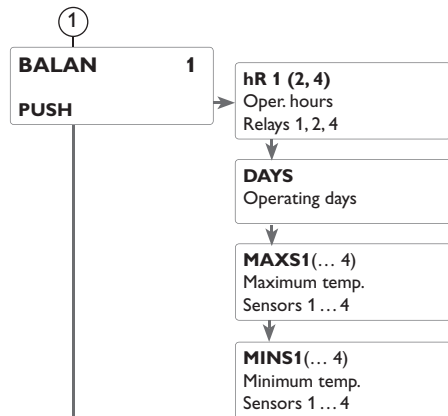

Adjustment level

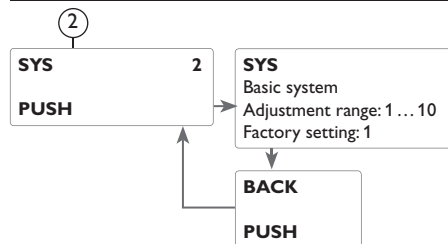

① Operating hours counter

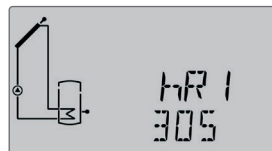

hR (1, 2, 4)

Operating hours counter

The operating hours counter accumulates the operating hours of the relay (**hR1 / hR2 / hR4**). Full hours are displayed.

The accumulated operating hours can be set back to zero (see page 20).

Operating days

Display of operating days since commissioning or last reset. The operating days cannot be set back to zero.

Minimum and maximum temperatures

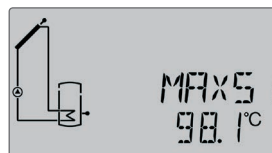

MAXS1(2, 3, 4)

Maximum temperatures at S1 ... S4

MINS1(2, 3, 4)

Minimum temperatures at S1 ... S4

Indication of the minimum and maximum temperatures at S1 ... S4.

The temperature indication can be set back to zero (see page 20).

② System

Selecting the system

Each system has pre-programmed options and adjustments which can be activated or changed respectively if necessary. Select the system first (see page 7).

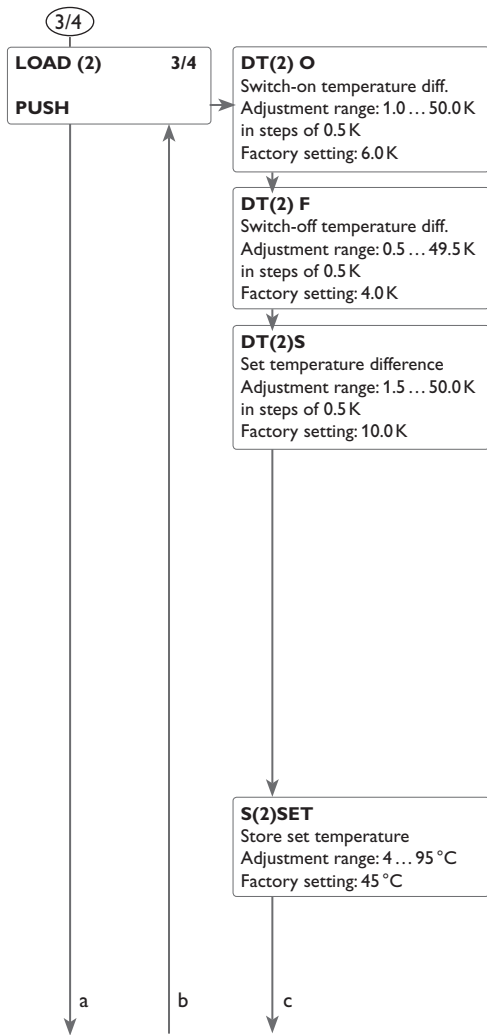

(3/4) ΔT control

The controller works as a standard differential controller. If the temperature reaches or exceeds the switch-on temperature difference, the pump switches on. When the temperature difference reaches or falls below the adjusted switch-off temperature difference, the respective relay switches off.



Note

The switch-on temperature difference must be 0.5K higher than the switch-off temperature difference. The set temperature difference must be at least 0.5K higher than the switch-on temperature difference.



Note

In systems with 2 stores or store loading in layers, 2 separate menus (**LOAD** and **LOAD 2**) will be displayed.

Speed control

If the temperature difference reaches or exceeds the switch-on temperature difference, the pump switches on at 100% speed for 10s. Then, the speed is reduced to the minimum pump speed value.

If the temperature difference reaches the adjusted set value, the pump speed increases by one step (10%). The response of the controller can be adapted via the parameter Rise. Each time the difference increases by the adjustable rise value, the pump speed increases by 10% until the maximum pump speed of 100% is reached. If the temperature difference decreases by the adjustable rise value, pump speed will be decreased by one step.



Note

To enable speed control, the corresponding relay has to be set to **AUTO**, **MIN**, **MAX** or **ADAP** (adjustment channel **MAN**) and relay control to **PULS**, **PSOL** or **PHEA** (adjustment channel **REL**).

Store set temperature

The store set temperature can be adjusted in the **S(2)SET** channel.



Note

For more information about relay control, see page 41.

3/4

a

b

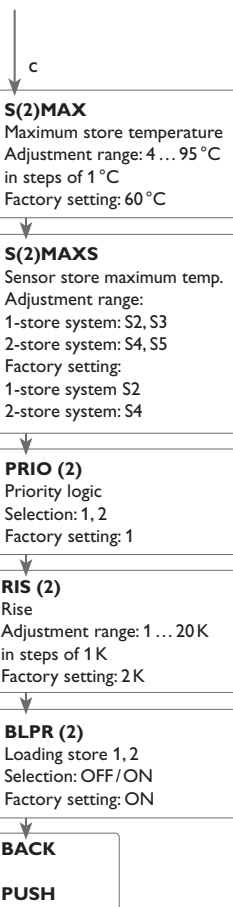
**3/4 Priority logic**

Priority logic can be used in 2-store systems or systems with store loading in layers only and determines how the heat is divided between the stores.

PRIO: Store 1/store base

PRIO2: Store 2/store top

The store which has been adjusted to 1 is considered as the priority store.

If both stores have been adjusted to an identical value, they will be loaded in parallel.

Store maximum temperature and Sensor store maximum temperature

If the store temperature reaches the adjusted maximum temperature, the store will no longer be loaded in order to avoid damage caused by overheating. If the maximum store temperature is exceeded, ✱ is displayed.

The sensor for store maximum limitation can be selected. The maximum limitation always refers to the sensor selected.

The switch-on hysteresis is selectable.

**Note**

In systems with 2 stores or store loading in layers, 2 separate menus (**LOAD** and **LOAD 2**) will be displayed.

Loading store

In systems with 2 stores or store loading in layers, one of the two stores or the store zone respectively can be switched off with the parameter **LST(2)**.

If **LST** or **LST2** is adjusted to **OFF**, the system runs like a 1-store system. The representation in the display remains the same.

5/6

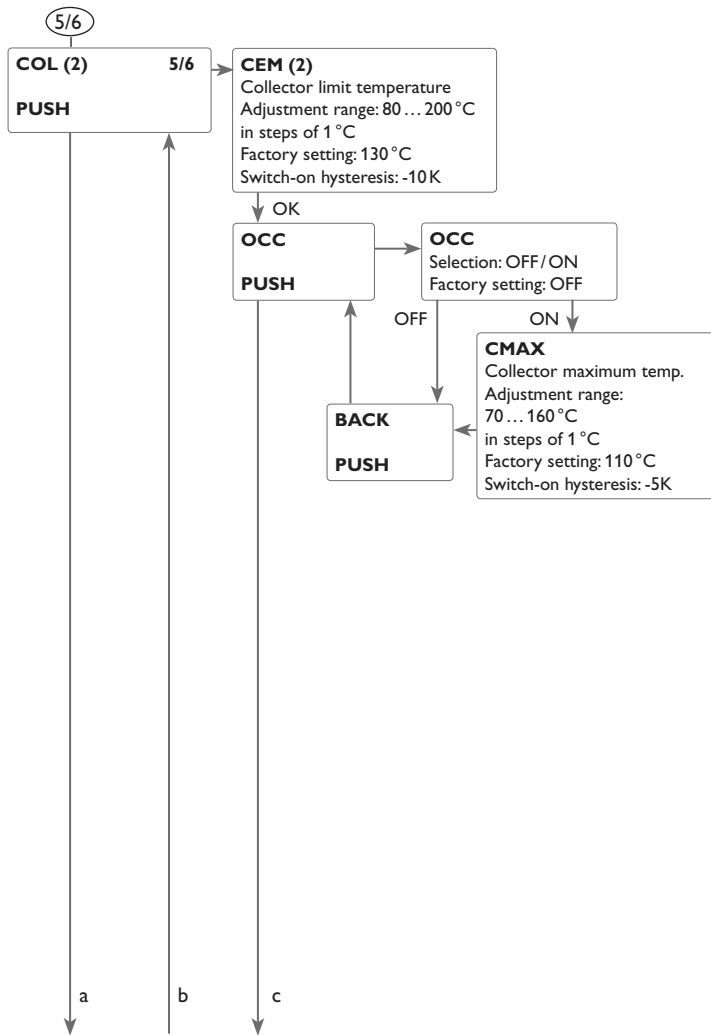

5/6 Collector emergency shutdown

When the collector temperature exceeds the adjusted collector limit temperature, the solar pump (R1/R2) switches off in order to protect the system components against overheating (collector emergency shutdown). If the maximum collector temperature is exceeded,  is displayed (flashing).



Note

If the drainback option is activated, the Adjustment range of the collector emergency temperature is changed to 80 ... 95 °C. Factory setting will be 95 °C.



Note

In systems with east-/west collectors, 2 separate menus (**COL** and **COL2**) will be displayed.

WARNING! Risk of injury! Risk of system damage by pressure surge!



If water is used as the heat transfer fluid in pressureless systems, water will boil at 100 °C.

→ In pressureless systems with water as the heat transfer fluid, do not set the collector limit temperature higher than 95 °C.

Collector cooling

The collector cooling function keeps the collector temperature within the operating range by heating the store. If the store temperature reaches 95 °C the function will switch off for safety reasons.

If the store temperature exceeds the adjusted maximum store temperature, the solar system is switched off. If the collector temperature increases to the adjusted maximum collector temperature, the solar pump is activated until the collector temperature falls below the maximum collector temperature. The store temperature may then exceed the maximum temperature, but only up to 95 °C (emergency shutdown of the store).

If the collector cooling is active,  is displayed (flashing).



Note

This function is only available if the system cooling function and the heat dump function are not activated.



Note

In systems with east-/west collectors, 2 separate menus (**COL** and **COL2**) will be displayed.

5/6

a

b

a

b

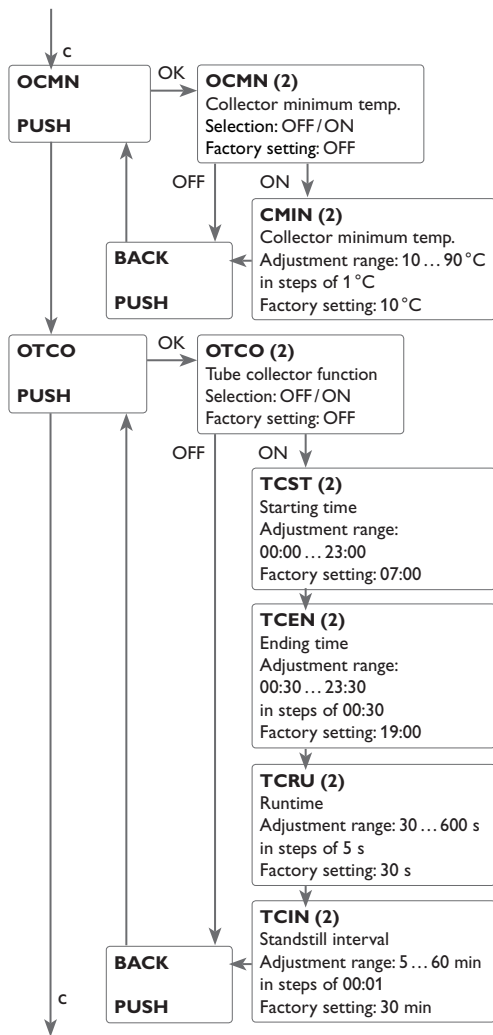

5/6 Collector minimum temperature

The minimum collector temperature is the minimum switch-on temperature which must be exceeded for the solar pump (R1/R2) to switch on. If the collector temperature falls below the adjusted minimum temperature, ☼ is displayed (flashing).



Note

In systems with east-/west collectors, 2 separate menus (**COL** and **COL2**) will be displayed.

Tube collector function

This function is used for improving the switch-on behaviour in systems with non-ideal sensor positions (e.g. with some tube collectors).

This function operates within an adjusted time frame. It activates the collector circuit pump for an adjustable runtime between adjustable standstill intervals in order to compensate for the delayed temperature measurement.

If the runtime is set to more than 10 s, the pump will be run at 100 % for the first 10 s of the runtime. For the remaining runtime, the pump will be run at the adjusted minimum speed.

If the collector sensor is defective or the collector is blocked, this function is suppressed or switched off.

2-collector systems

In 2-collector systems, the tube collector function is available for each individual collector field.

In 2-collector systems, the tube collector function will affect the inactive collector field only. The solar pump of the active collector field will remain switched on until the switch-off conditions are fulfilled.



Note

If the drainback option is activated, the tube collector function will not be available.

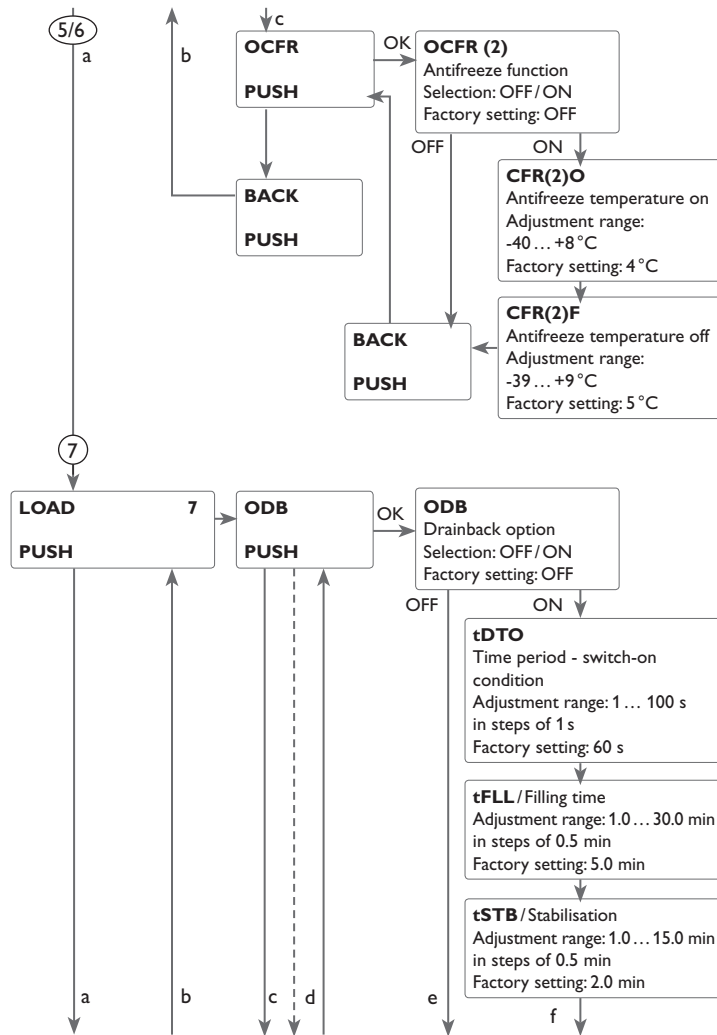

5/6 Antifreeze function

The antifreeze function activates the loading circuit between the collector and the store when the collector temperature falls below the adjusted temperature **CFRO**. This will protect the fluid against freezing or coagulating. If **CFRF** is exceeded, the solar pump will be switched off again.

The antifreeze function will be suppressed if the store temperature of the selected store falls below 5 °C. In 2-store systems, the function then switches to the second store or, in the case of store loading in layers, to the upper store zone. If the temperature of the second store (or of the upper store zone respectively) also falls below 5 °C, the system will be switched off.



Note

In systems with east-/west collectors, 2 separate menus (**COL** and **COL 2**) will be displayed.



Note

Since this function uses the limited heat quantity of the store, the antifreeze function should be used in regions with few days of temperatures around the freezing point.

7 Drainback option

In a drainback system, the heat transfer fluid will flow into a holding tank if solar loading does not take place. The drainback option initiates the filling process if solar loading is about to start. If the drainback option is activated, the following adjustment can be made.



Note

A drainback system requires additional components such as a holding tank. The drainback option should only be activated if all components required are properly installed.

Time period – switch-on condition

The parameter **tDTO** is used for adjusting the time period during which the switch-on condition must be permanently fulfilled.

Filling time

The filling time can be adjusted using the parameter **tFLL**. During this period, the pump runs at 100 % speed.

Stabilisation

The parameter **tSTB** is used for adjusting the time period during which the switch-off condition will be ignored after the filling time has ended.

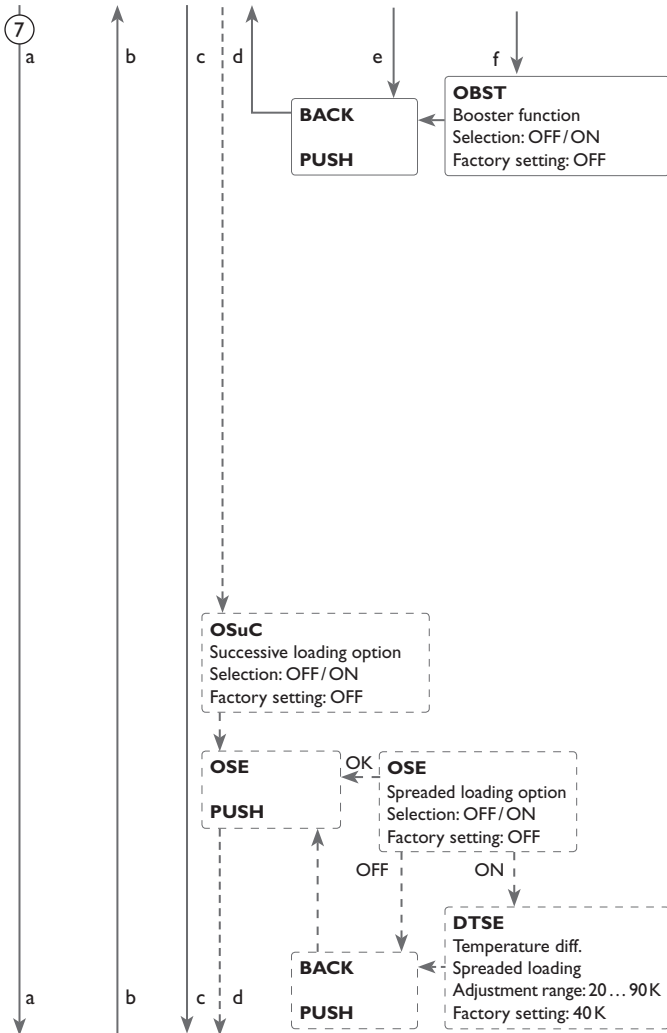

i Note

If the drainback option is activated, the cooling functions and the antifreeze function will not be available.

The **H-DAY** menu (holiday function) will also not be available and cannot be selected by means of the microbutton .

i Note

The drainback option is only available in systems with 1 store and 1 collector field and if no cooling function is activated.

i Note

If the drainback function **ODB** is activated, the Factory settings of the parameters **DT O**, **DT F** und **DT S** will be adapted to values suiting drainback systems:

DT O = 10 K

DT F = 4 K

DT S = 15 K

Additionally, the adjustment range and the factory setting of the collector emergency shutdown **CEM** will change:

Adjustment range: 80... 120 °C;

Factory setting: 95 °C

Adjustments previously made in these channels will be overridden and have to be entered again if the drainback option is deactivated later on.

i Note

If the holiday function is activated, the drainback option will not be available.

Booster function

This function is used for additionally switching on a second pump when filling the system. pump when filling the solar system. When solar loading starts, R2 is energised in parallel to R1. After the filling time has elapsed, R2 switches off.

i Note

The booster function is available in system 1 only.

Successive loading option

Successive loading means that the priority store will be loaded up to its maximum temperature. If it is reached, the second store will be loaded. If the temperature of the first store falls below the store set temperature, the second store will no longer be loaded, regardless of whether the switch-on conditions of the priority store or of the subordinate store are fulfilled or not.

If both store have been loaded to their set temperature, the same process described above will take place until the stores have reached their maximum temperature.

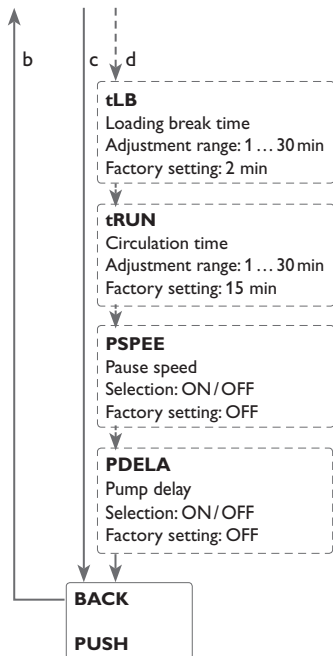

Spreaded loading option

In 2-store systems with 2 pumps, a spreaded loading function can be activated:

As soon as the adjustable temperature difference **DTSE** between the collector and the priority store is reached, the second store will be loaded in parallel unless it is blocked. If the temperature difference falls by 2 K below **DTSE**, the pump is switched off.

The collector temperature has to be higher than the store temperature.

Loading logic

In systems with 2 stores or store loading in layers, store sequence control can be adjusted.

In 1-store systems, only the menu item **Pump delay** will be available.

Store sequence control

If the priority store cannot be loaded, the subordinate store will be checked. If useful heat can be added, it will be loaded for the circulation time.

After this, the loading process stops and the controller monitors the increase in collector temperature during the loading break time. If it increases by 2 K, the break time timer starts again to allow the collector to gain more heat. If the collector temperature does not increase sufficiently, the subordinate store will be loaded again for the Circ. time as before.

As soon as the switch-on condition of the priority store is fulfilled, it will be loaded. If the switch-on condition of the priority store is not fulfilled, loading of the subordinate store will be continued. If the priority store reaches its set temperature, store sequence control will not be carried out.

The minimum runtime of each loading process is 3 min.

In systems with 2 stores or store loading in layers, all stores/store zones will be loaded to their set temperature (according to their priority and store sequence control). Only when all stores/store zones have exceeded their set temperature will they be loaded up to their maximum temperatures, again according to their priority and store sequence control.

If store sequence control is active and the system switches to load the priority store, the parameter Loading break also acts as a stabilisation time, during which the switch off temperature difference will be ignored.

Overrun

By means of this function, store loading continues after the temperature difference between the collector and the store has fallen below the switch-off difference. It switches off if the temperature difference between the allocated flow and return sensors falls below the switch-off difference **DT(2)F**.

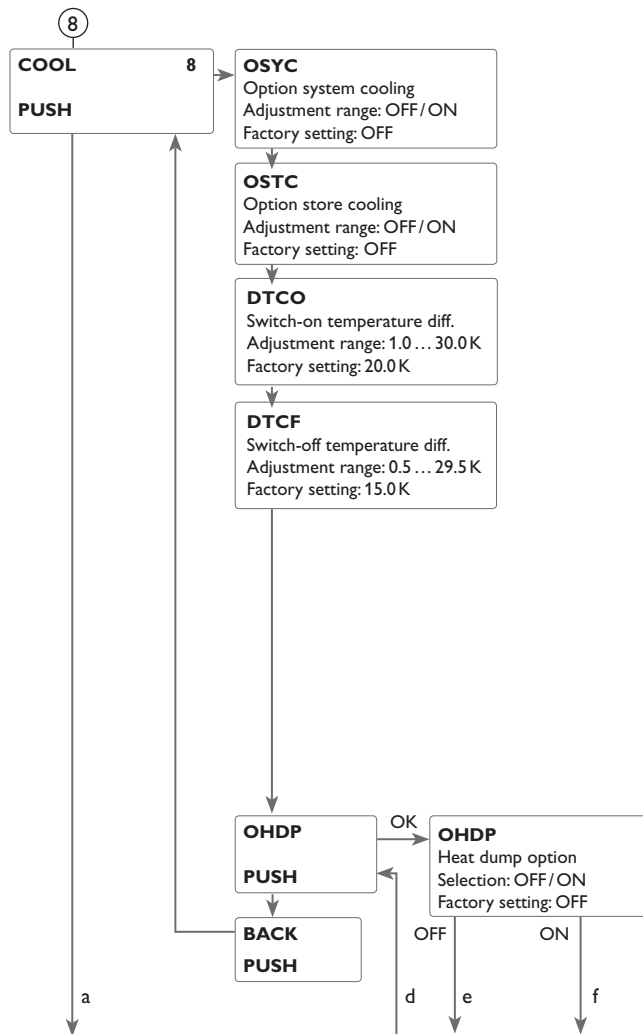

8 Cooling functions

Different cooling functions can be activated: system cooling, store cooling and heat dump.



Note

If the temperature at the store sensor reaches 95 °C, all cooling functions will be blocked. The switch-on hysteresis is -5 K.



Note

If one of the cooling functions or the antifreeze function is activated, the drainback option will not be available.

System cooling

The system cooling function aims to keep the solar system operational for a longer time. The function overrides the maximum store temperature to provide thermal relief of the collector field and the heat transfer fluid on hot days.

If the store temperature is higher than the adjusted maximum store temperature and the switch-on temperature difference **DTO** is reached, the solar pump remains switched on or will be switched on. Solar loading is continued until either the temperature difference falls below the adjusted value **DTF** or the collector limit temperature is reached.

In 2-store systems the sequence of the stores can be adjusted.

If the system cooling is active, ✨ is displayed (flashing).



Note

This function will only be available if the collector cooling function, the heat dump function, and the drainback option are not activated.

Store cooling

When the store cooling function is activated, the controller aims to cool down the store during the night in order to prepare it for solar loading on the following day.

If the adjusted maximum store temperature is exceeded and the collector temperature falls below the store temperature, the system will be reactivated in order to cool down the store.

DTCO and **DTCF** are used as the reference temperature differences.

Heat dump

The heat dump function can be used to direct excess heat generated by strong solar irradiation to an external heat exchanger (e.g. fan coil) in order to keep the collector temperature within the operating range.

The heat dump function can either use an additional pump or valve (**OTPUM ON** = pump logic, **OTPUM OFF** = valve logic).

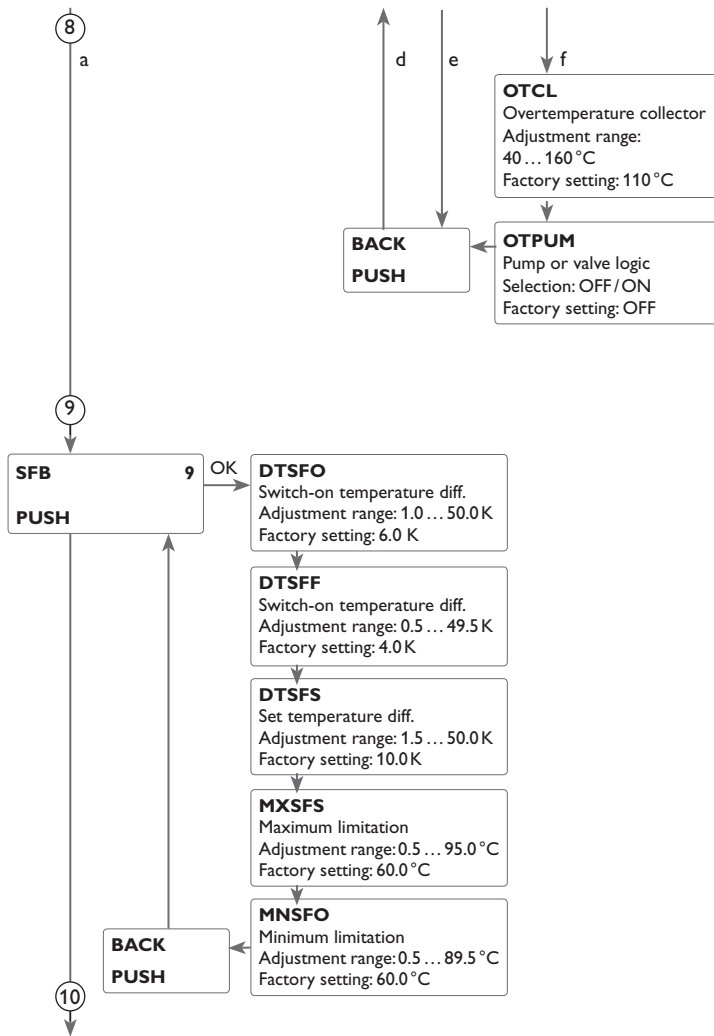

Variant pump:

The allocated relay is energised with 100%, if the collector temperature reaches the adjusted switch-on temperature.

If the collector temperature falls by 5 K below the adjusted collector overtemperature, the relay will be switched off. In the variant pump, the heat dump function works independent from solar loading.

Variant valve:

The allocated relay will be energised in parallel to the solar pump, if the collector temperature reaches the adjusted collector overtemperature. If the collector temperature falls by 5K below the adjusted collector overtemperature, the relay will be switched off.

If the store temperature exceeds its maximum temperature by more than 5K while the heat dump function is being active, the function will be deactivated. If the temperature falls below this value by the **hysteresis maximum store temperature (HYSP(2) in BEL(2))**, the heat dump function is will be available again.



Note

In system 1, the adjustable value **OTCL** is blocked against the collector emergency temperature by 10K. This function will only be available if the collector cooling function, the heat dump function, and the drainback option are deactivated.

9 Solid fuel boiler

The Solid fuel boiler function can be used for transferring heat from a solid fuel boiler to a store.

The relay (system-dependent) is energised when all switch-on conditions are fulfilled:

- the temperature difference between the sensors heat source and heat sink has exceeded the switch-on temperature difference.
- the temperature at the solid fuel boiler sensor has exceeded the minimum temperature
- the temperature at the store sensor has fallen below the maximum temperature

When the Set temperature difference is exceeded, pump speed control starts. For every increase or decrease by the rise value, the pump speed will be adjusted by 10%.

The switch-on hysteresis is -5K.

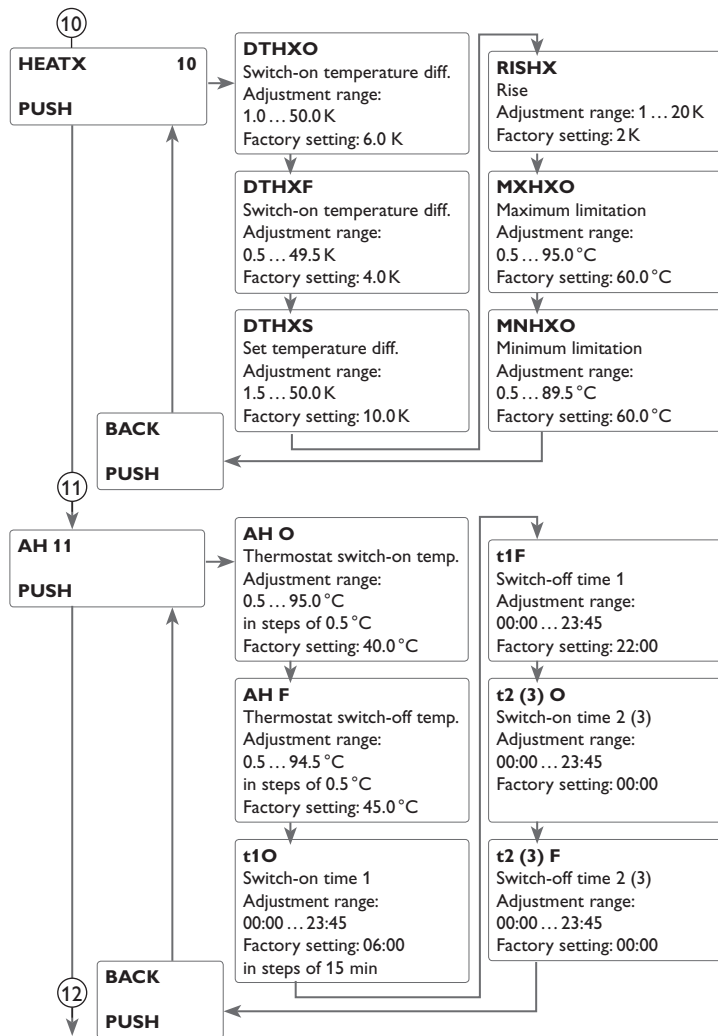

⑩ Heat exchange function

The Heat exchange function can be used for transferring heat from a heat source to a heat sink.

The relay (system-dependent) is energised when all switch-on conditions are fulfilled:

- the temperature difference between the sensors heat source and heat sink has exceeded the switch-on temperature difference.
- the temperature at the heat source sensor has exceeded the minimum temperature
- the temperature at the heat sink sensor has fallen below the maximum temperature

When the Set temperature difference is exceeded, pump speed control starts. For every increase or decrease by the rise value, the pump speed will be adjusted by 10%.

⑪ Afterheating/Thermostat function

The Thermostat function works independently from the solar operation and can e.g. be used for using surplus energy or for afterheating.

- **AH O < AH F**
thermostat function for afterheating
- **AH O > AH F**
thermostat function for using surplus energy

In order to block the thermostat function for a certain period, there are 3 time frames t1 ... t3. The switch-on and switch-off times can be adjusted in steps of 15 min. If the switch-on and the switch-off times are identical, the time frame is inactive.

If the thermostat function is supposed to run from 06:00 a.m. and 09:00 a.m. only, adjust t1 O to 06:00 a.m. and t1 F to 09:00 a.m.

The first time frame is factory set from 06:00 to 22:00.

If all time frames are set to 00:00, the thermostat function is solely temperature dependent.

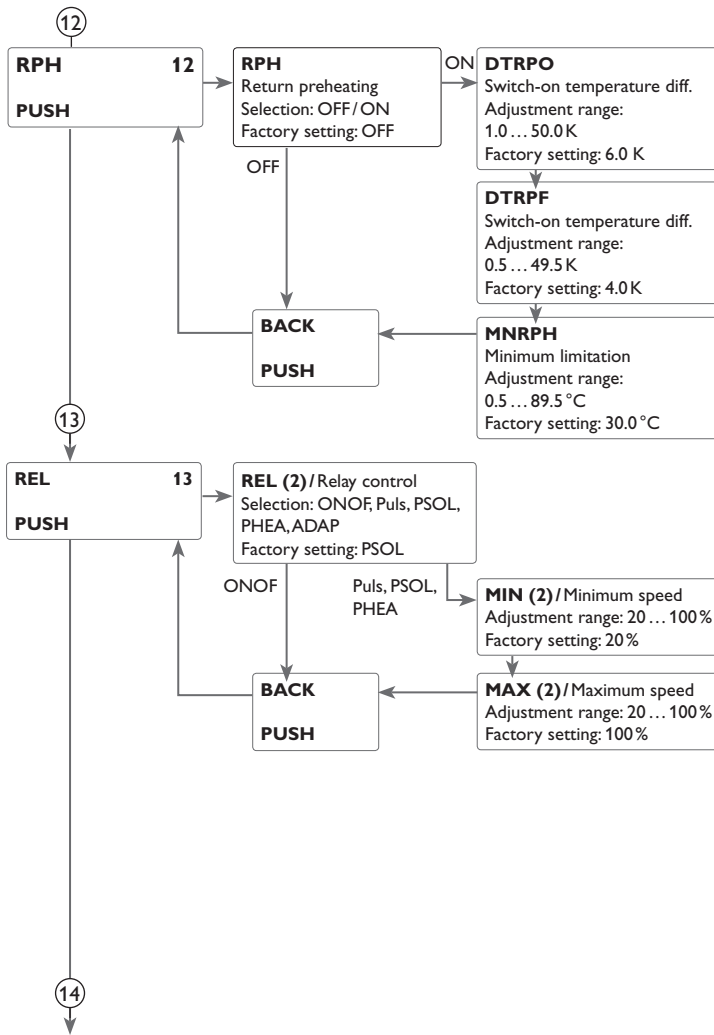

12 Return preheating

The Return preheating function can be used for transferring heat from a heat source to the heating circuit return.

The relay (system-dependent) is energised when both switch-on conditions are fulfilled:

- the temperature difference between the sensors store return and heating circuit return has exceeded the switch-on temperature difference.
- the temperature at the heating circuit return has exceeded the minimum temperature.

The switch-on hysteresis is -5 K.

13 Relay control

With this parameter, the relay control type can be adjusted. The following types can be selected:

Adjustment for standard pump without speed control

- ONOF: Pump on/pump off

Adjustment for standard pump with speed control

- PULS : Burst control via semiconductor relay

Adjustment for high-efficiency pump (HE pump)

- PSOL : PWM profile solar pump
- PHEA : PWM profile heating pump



Note

For more information about connecting HE pumps, see page 18.

Minimum speed

In the adjustment channel **MIN (2)** a relative minimum speed for connected pumps can be allocated to the outputs R1 and R2.



Note

When loads which are not speed-controlled (e. g. valves) are used, the pump speed value of the corresponding relay must be set to 100 % or the control type must be set to ONOF in order to deactivate pump speed control.

Maximum speed

In the adjustment channel **MAX (2)** a relative minimum speed for connected pumps can be allocated to the outputs R1 and R2.



Note

When loads which are not speed-controlled (e. g. valves) are used, the pump speed value of the corresponding relay must be set to 100 % or the control type must be set to ONOF in order to deactivate pump speed control.

Relay allocation for PWM outputs:

PWMA - Relay 1

PWMB - Relay 2

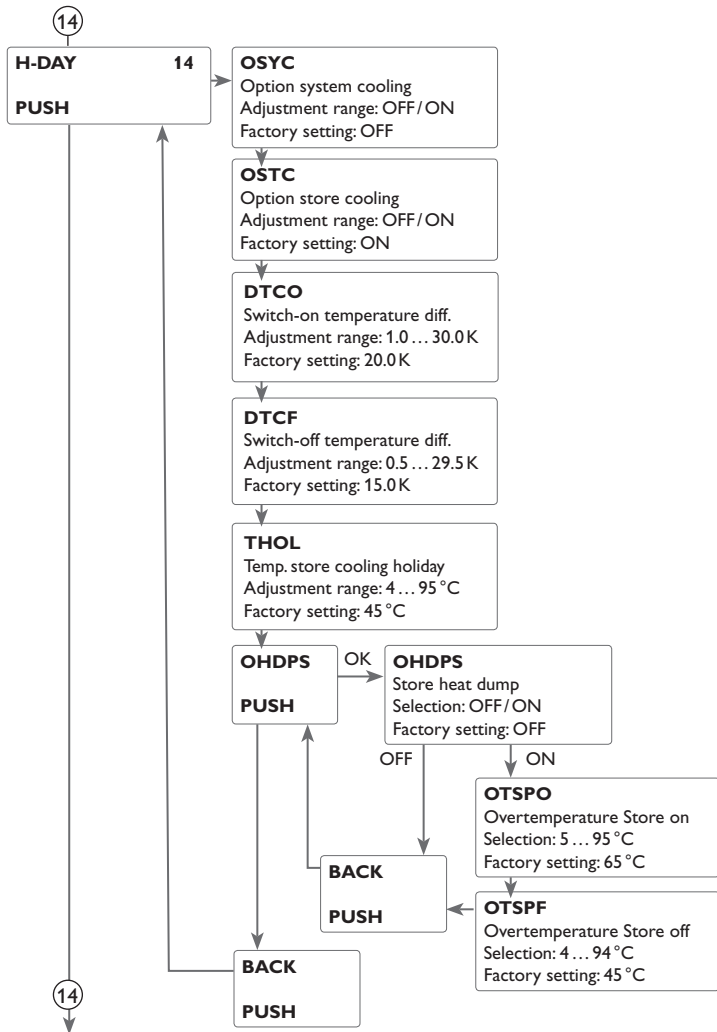

14 Holiday function

The Holiday function is used for operating the system when no water consumption is expected, e. g. during a holiday absence. This function cools down the system in order to reduce the thermal load.

Only if the holiday function has been activated with the parameter **DAYS** will the adjustments described in the following become active.

3 cooling functions are available: system cooling, store cooling and store heat dump.

The system cooling function aims to keep the solar system operational for a longer time. The function overrides the maximum store temperature to provide thermal relief of the collector field and the heat transfer fluid on hot days.

The system cooling option can be activated with the parameter **OSYC**. The function uses the adjustable switch-on and switch-off temperature differences **DTO** and **DTF** from the **BEL1(2)** menu.

The store cooling option is activated by default and can be deactivated with the parameter **OSTC**. Store cooling starts when the store temperature exceeds the collector temperature by the adjustable value **DTCO**. It switches off if the store temperature reaches **THOL** or if the temperature difference falls below **DTCF**. The parameter **THOL** is used for adjusting the temperature for store cooling.

The store heat dump function can be used to direct excess heat generated by strong solar irradiation from the store to an external heat exchanger (e. g. fan coil) or radiator in order to prevent the collectors from overheating. The store heat dump function is independent of the solar system and can be activated with the parameter **OHDPS**. The function uses the adjustable switch-on and switch-off temperature differences **OTSPO** and **OTSPF**. If temperature measured at sensor 3 reaches the switch-on temperature, relay 2 will be energised until the temperature falls below the switch-off value.

The parameter **DAYS** can be used for entering the number of days for a holiday absence. If the parameter is set to a value higher than 0, the function becomes active using the adjustments that have previously been made in the **H-DAY** menu. The days will be counted backwards at 00:00. If the value is set to 0, the function is deactivated.

Note
The **OHDPS** option is available in system 1 only.

Note
The parameter **DAYS** can be accessed via the microbutton  only (see page 30).

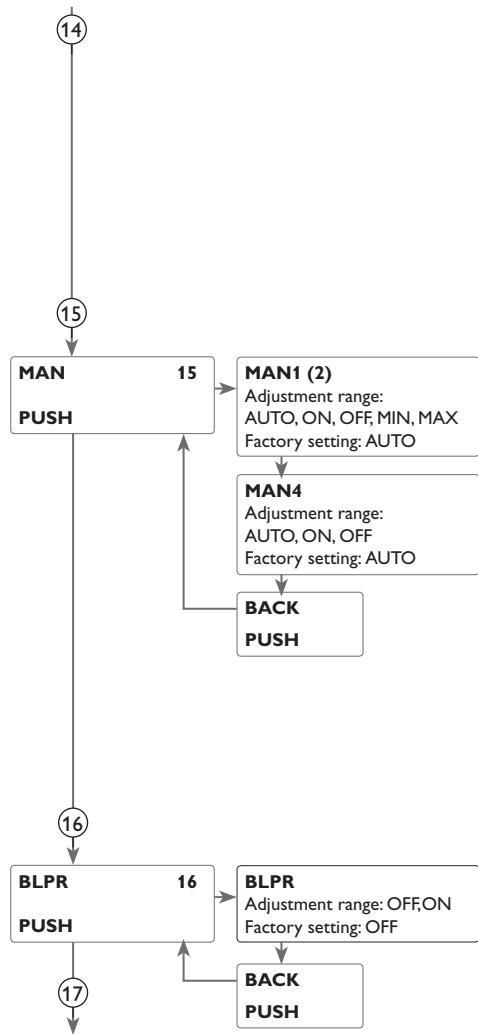

Note
The adjustments described in this chapter are independent of those in the **COOL** menu, which are inactive during a holiday.

Note
When the drainback option is activated, the holiday function will not be available and cannot be selected by means of the microbutton .

Note
If the holiday function is activated, the drainback option will not be available.

15 Manual mode

For control and service work, the operating mode of the relays can be manually adjusted. For this purpose, select the adjustment channel MAN1(2, 4) (for R1, 2, 4) in which the following adjustments can be made:

Operating mode

AUTO : relay in automatic mode

OFF : relay is switched off

MIN : relay is switched with adjusted maximum speed (not if REL = ONOF)

MAX : relay is switched with adjusted maximum speed (not if REL = ONOF)

Note
After service and maintenance work, set the relay mode back to AUTO. Normal operation is not possible in manual mode.

Note
For information about the control LED in the Lightwheel® see page 19.

16 Blocking protection

In order to protect the pumps against blocking after standstill, the controller is equipped with a blocking protection function. This function switches on the relays one after another every day at 12:00 a.m. for 10 s at 100 %.

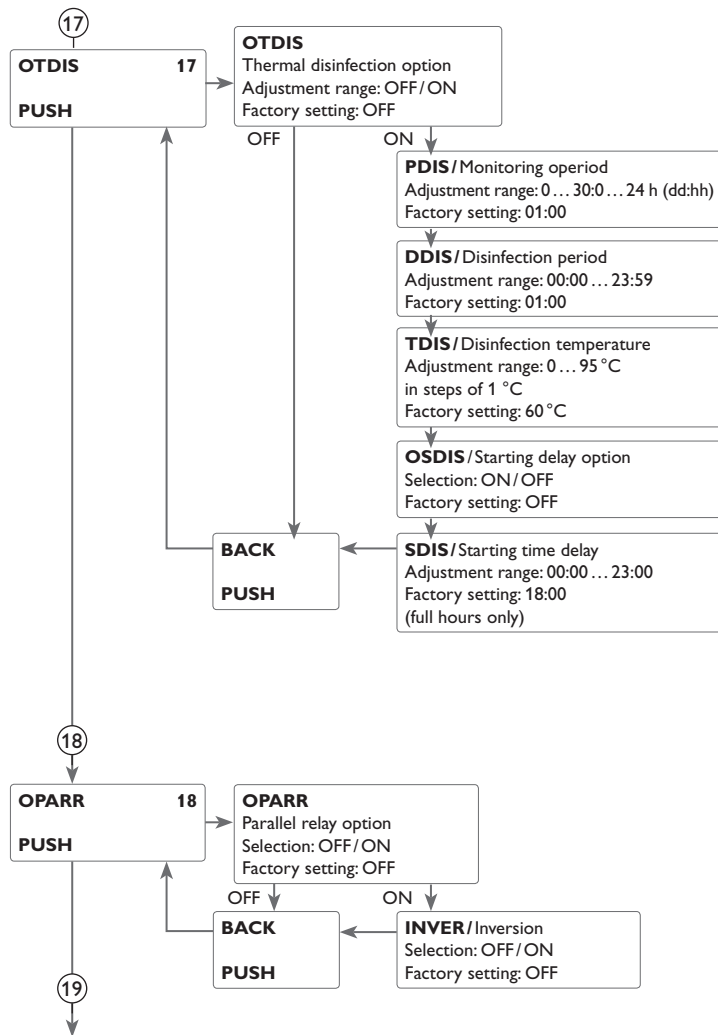

17 Thermal disinfection

This function helps to contain the spread of Legionella in DHW stores by systematically activating the afterheating.

R2 is used as the reference relay, S3 is used as the reference sensor.

For thermal disinfection, the temperature at the reference sensor will be monitored. Protection is ensured when, during the monitoring period, the disinfection temperature is continuously exceeded for the entire disinfection period.

The monitoring period starts as soon as the temperature at the reference sensor falls below the disinfection temperature. When the monitoring period ends, R2 and R4 activate the circulating pump and the afterheating. The disinfection period starts, if the temperature at the allocated sensor exceeds the disinfection temperature.

Thermal disinfection can only be completed when the disinfection temperature is exceeded for the duration of the disinfection period without any interruption.

Starting time delay

If the starting delay option is activated, a starting time for the thermal disinfection with starting delay can be adjusted. The activation of the afterheating is then delayed until that starting time after the monitoring period has ended.

If the monitoring period ends, for example, at 12:00 o'clock, and the starting time has been set to 18:00, the reference relay will be energised with a delay of 6 hours at 18:00 instead of 12:00 o'clock.



Note

If the thermal disinfection option is activated, the display channels **TDIS**, **CDIS**, **SDIS** and **DDIS** will be displayed.

18 Parallel relay

With this function, e. g. a valve can be controlled in parallel to the pump via a separate relay.

If solar loading takes place or if a solar function is active, the relay selected will be energised. The parallel relay can also be energised inversely.



Note

If R1 is in the manual mode, the selected parallel relay will not be energised.

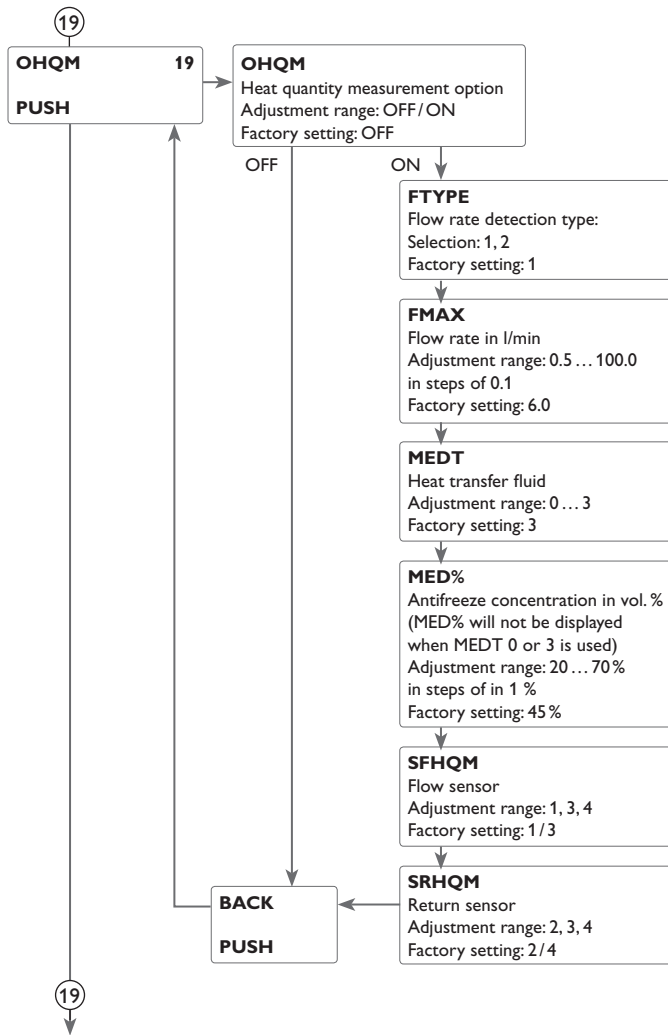

19 Heat quantity measurement

The heat quantity measurement can be carried out in 2 different ways: with a fixed flow rate value or with an impulse flowmeter at the V40 impulse input.



Note

The most precise heat quantity measurement is achieved by using sensors in the flow and return pipes as well as an impulse flowmeter. In 2-collector systems, heat quantity measurement can only be carried out with sensors installed in the common flow and return pipes.

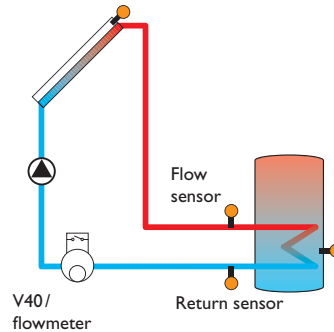

Example of flow and return sensor positions for heat quantity measurement.

- ➔ Enable the heat quantity measurement option in the channel **OHQM**.
- ➔ Select the type of flow rate detection in the channel **FTYPE**.

Flow rate detection type:

- 1 : Fixed flow rate value
(to be read from the flowmeter in the solar circuit)
- 2 : V40



Note

If the flow rate detection type V40 has been adjusted, the impulse rate of the sensor must be adjusted in the **SENS** menu (see page 46).

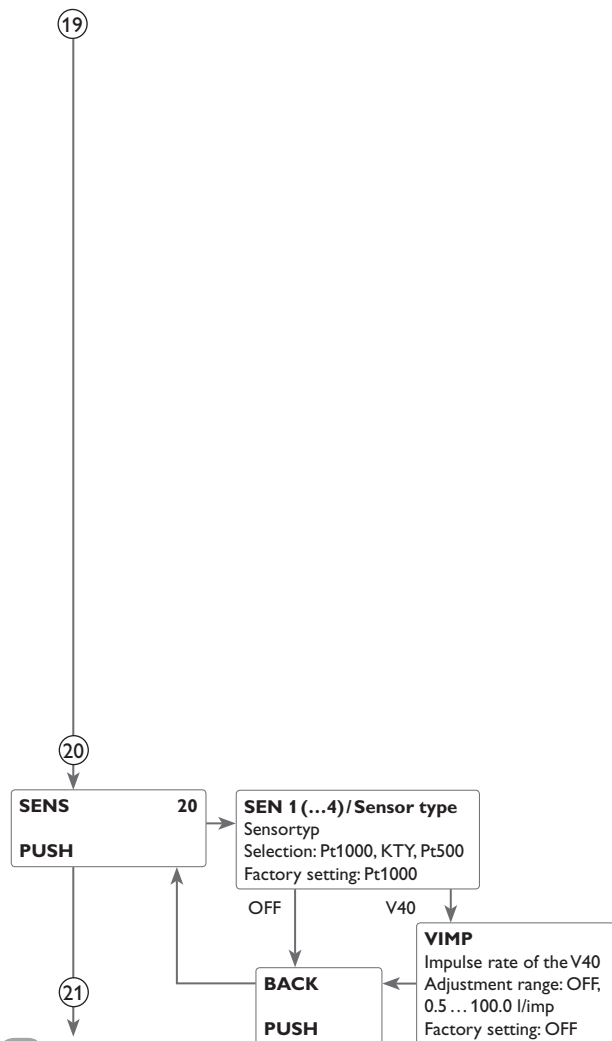

19 Heat quantity measurement with fixed flow rate value

The heat quantity balancing (estimation) uses the difference between the flow and return temperatures and the entered flow rate (at 100% pump speed).

- ➔ Adjust **1** in the channel **FTYPE**.
- ➔ Read the flow rate (l/min) from the flowmeter and adjust it in the **FMAX** channel.
- ➔ Adjust the antifreeze type and concentration of the heat transfer fluid in the channels **MEDT** and **MED%**.



Note

Heat quantity measurement is not possible in systems with 2 solar pumps.

Antifreeze type:

- 0 : Water
- 1 : Propylene glycol
- 2 : Ethylene glycol
- 3 : Tyfocor® LS/G-LS

Heat quantity measurement with impulse flowmeter at the V40 input:

The heat quantity measurement uses the difference between the flow and return temperatures and the flow rate transmitted.

- ➔ Adjust **2** in the channel **FTYPE**.
- ➔ Adjust the antifreeze type and concentration of the heat transfer fluid in the channels **MEDT** and **MED%**.

HQM sensors

The flow sensor as well as the return sensor can be selected for heat quantity measurement.

- ➔ In the channel **SFHQM** select the flow sensor.
- ➔ In the channel **SRHQM** select the return sensor.

20 Sensors

The sensor type can be selected for the sensor inputs S1 to S4.

The impulse rate can be adjusted for the impulse flowmeter input V40.

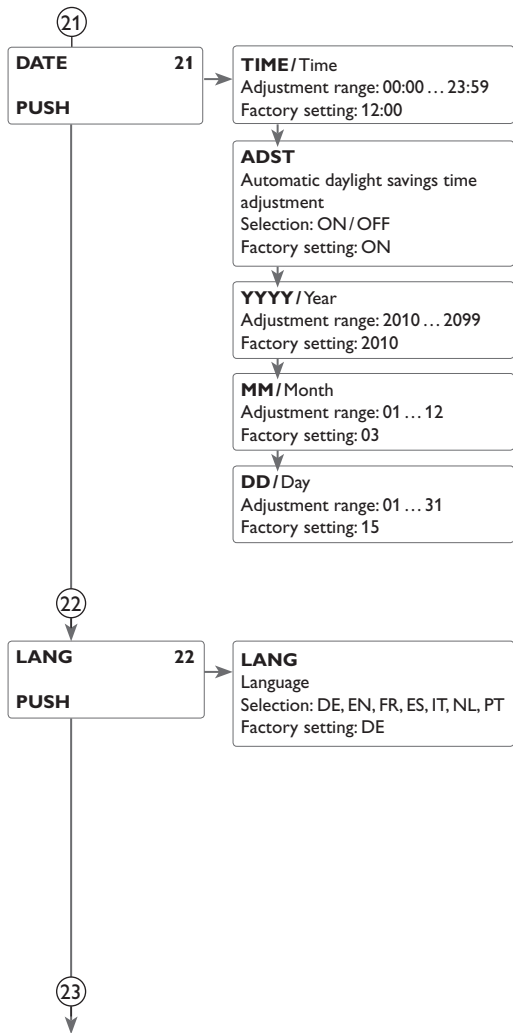

21 Time and date

The controller is equipped with a real time clock required e.g. for the thermostat function.

In the display, the lower line indicates the day followed by the month.

22 Language

In this adjustment channel the menu language can be selected.

- DE : Deutsch
- EN : English
- FR : French
- ES : Spanish
- IT : Italian
- NL : Dutch
- PT : Portuguese

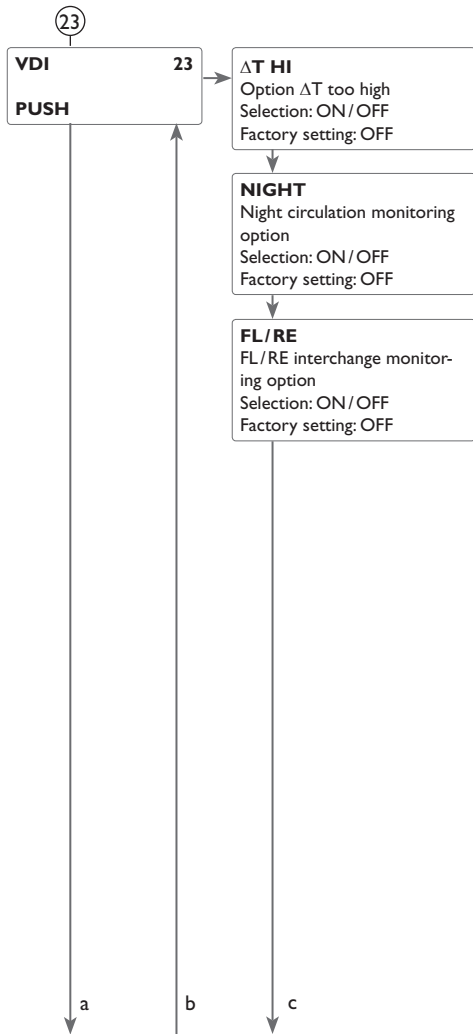

23 Function control

ΔT monitoring

This function is used for monitoring the temperature difference. The message ΔT too high is shown if solar loading has been carried out for a period of 20 min with a differential higher than 50K. Normal operation is not aborted or inhibited, but the system should be checked for the cause of the warning.

Possible causes are:

- pump power too weak
- blocked system components
- circulation problems in the collector
- air inside the pipework
- defective valve/ defective pump

Night circulation

This function can be used for detecting thermal circulation inside the solar circuit that leads to an unwanted cooling of the store. A warning message will appear when the following condition has been detected for at least 1 min during the period between 11 p.m. and 5 a.m.:

- collector temperature exceeds 40 °C

The delay time of 1 min ensures that the message is not triggered by short-term fault conditions.

Possible causes are:

- defective non-return valves
- defective valve
- wrongly adjusted time

Flow and return interchanged

This function is used for detecting an interchange of the flow and return pipe or a badly placed collector sensor. For this purpose, the collector temperature is monitored for plausibility during the switch-on phases of the solar pump. The message FL/RE interchanged will appear, when the plausibility criteria have not been met 5 times in a row.

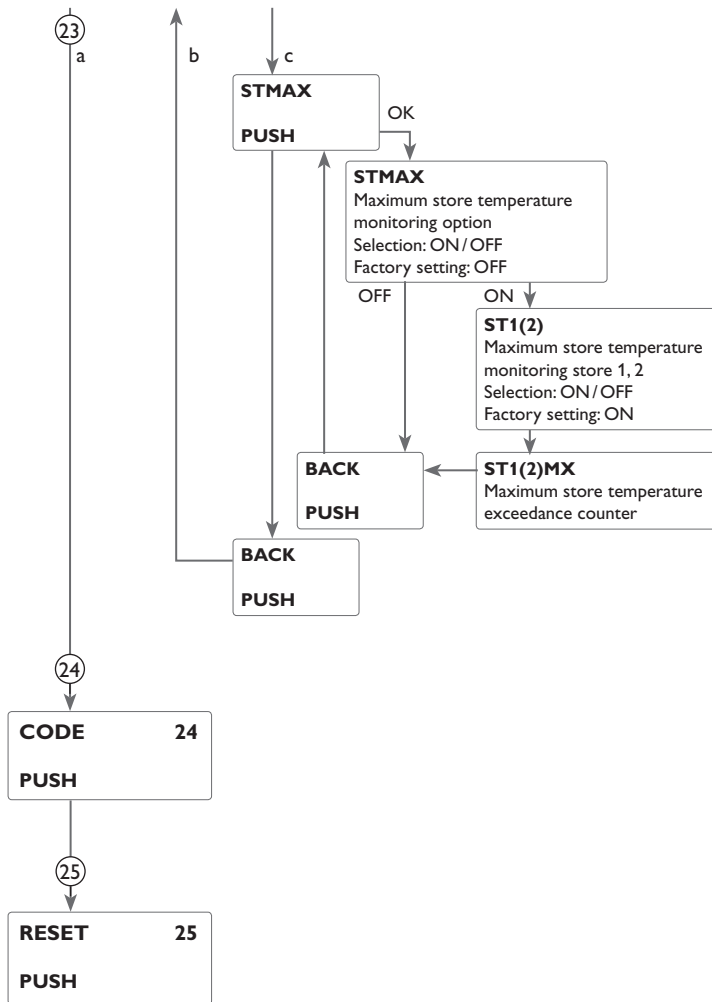

Maximum store temperature

This function is used for detecting and indicating if the adjusted maximum store temperature has been exceeded. The controller compares the current store temperature to the adjusted maximum store temperature, thus monitoring the store loading circuits.

The maximum store temperature is considered exceeded when the temperature measured at the store sensor exceeds the adjusted maximum store temperature by at least 5 K. The monitoring becomes active again as soon as the store temperature falls below the adjusted maximum store temperature.

The channels **ST1**, **ST2** can be used for selecting the stores to be monitored. The number of exceedances is displayed in the **ST(2)MX** channels. A possible cause for an unwanted exceedance of the maximum store temperature is a defective valve.



Note

Only if the installer code is entered (see page 50), will the option be available.

24 CODE

The user code can be entered in the **CODE** channel (see page 50).

25 Reset

By means of the reset function, all adjustments can be set back to the factory settings. To do so, the installer code must be entered (see page 50).

9 User code and short menu – Adjustment values

CODE

The access to some adjustment values can be restricted via a user code (customer).

1. Installer **2962** (Factory setting)

All menus and adjustment values are shown and all values can be altered.

2. Customer **0000**

The installer level is not shown, adjustment values can be changed partly.

For safety reasons, the user code should generally be set to the customer code before the controller is handed to the customer!

➔ In order to restrict the access, enter 0000 in the menu item **CODE**.

The display changes to the status level. The short menu shown will then be available in the adjustment level. The short menu suits the selected system.

➔ In order to authorise access to the installer level, enter 2962 in the menu item **CODE**.

Short menu

Channel	Factory setting	Adjustment range	Designation
TIME	12:00	00:00 ... 23:59	Time
DT O	6.0K	1.0 ... 50.0K	Switch-on temperature difference store
DT F	4.0K	0.5 ... 49.5K	Switch-off temperature difference store
S SET	45 °C	5.0 ... 95.0 °C	Store set temperature
S MAX	60 °C	4 ... 95 °C	Store maximum limitation
LST	ON	ON/OFF	Loading store on
DT2O	6.0K	1.0 ... 50.0K	Switch-on temperature difference store 2
DT2F	4.0K	0.5 ... 49.5K	Switch-off temperature difference store 2
S2SET	45 °C	5.0 ... 95.0 °C	Set store temperature store 2
S2MAX	60 °C	4 ... 95K	Store maximum limitation store 2
LST2	ON	ON/OFF	Loading store 2 on
CODE	0000	0000/2962	User code

10 Messages

In the case of an error, the control LED starts flashing red and a message is indicated in the status display. A warning triangle is additionally indicated. If more than one error or fault condition has occurred, only the one with the highest priority will be displayed as a message in the status display.



Note

Error codes are indicated as CODE 00## in the status display. The CODE menu for adjusting the user code can be found in the adjustment level.

In the case of a sensor error, the system switches off, and a message appears on the display. Additionally, a corresponding value for the error type assumed is indicated.

Error code display	Plain text display	Monitoring function	Cause
0001	!LINE BREAK SENSOR X!	Sensor line break	Sensor line broken
0002	!SHORT CIRCUIT SENSOR X!	Sensor short circuit	Sensor line short-circuited
0011	!ΔT TOO HIGH!	ΔT too high	Collector 50 K > than store to be loaded
0021	!NIGHT CIRCULATION!	Night circulation	Betw. 11 p.m. and 5 a.m. col. temp > 40 °C
0031	!FL/RE INTERCHANGED!	FL/RL interchanged	Col. temp. does not rise after switching on
0061	!DATA MEMORY DEFECTIVE!	Storing and changing adjustments not possible	
0081	STORE MAX EXCEEDED	Maximum store temperature	St. max has been exceeded

After the error has been removed and acknowledged, the error message disappears.

➔ In order to acknowledge an error message, select the message and press the left button (↵) for 2s.





Note

The function control „flow and return interchanged“ according to the VDI guidelines 2169 can only correctly detect and indicate the error „0031 !FL/RE INTERCHANGED!“ if the collector sensor measures the temperature directly in the fluid at the collector outlet. If the collector sensor is not correctly placed, a false message may occur.

➔ Place the collector sensor directly in the fluid at the collector outlet or deactivate the “flow and return interchanged” function control.

11 Troubleshooting

Control LED in the Lightwheel® is flashing red. The symbol  is indicated on the display and the symbol  is flashing.

Sensor fault. An error code instead of a temperature is shown on the corresponding sensor display channel.

888.8

-88.8

Cable is broken.
Check the cable.

Short circuit.
Check the cable.

Disconnected temperature sensors can be checked with an ohmmeter. Please check if the resistance values correspond with the table.

°C	°F	Ω Pt500	Ω Pt1000	Ω KTY	°C	°F	Ω Pt500	Ω Pt1000	Ω KTY
-10	14	481	961	1499	55	131	607	1213	2502
-5	23	490	980	1565	60	140	616	1232	2592
0	32	500	1000	1633	65	149	626	1252	2684
5	41	510	1019	1702	70	158	636	1271	2778
10	50	520	1039	1774	75	167	645	1290	2874
15	59	529	1058	1847	80	176	655	1309	2971
20	68	539	1078	1922	85	185	664	1328	3071
25	77	549	1097	2000	90	194	634	1347	3172
30	86	559	1117	2079	95	203	683	1366	3275
35	95	568	1136	2159	100	212	693	1385	3380
40	104	578	1155	2242	105	221	702	1404	3484
45	113	588	1175	2327	110	230	712	1423	3590
50	122	597	1194	2413	115	239	721	1442	3695

If a malfunction occurs, a message will appear on the display of the controller.

Lightwheel® or display are permanently off.

Press the right button . Display illuminated?

no

yes

Controller has been in standby, everything o.k.

Check the power supply of the controller. Is it disconnected?

no

yes

The fuse of the controller could be blown. The fuse holder (which holds the spare fuse) becomes accessible when the cover is removed. The fuse can then be replaced.

Check the supply line and reconnect it.

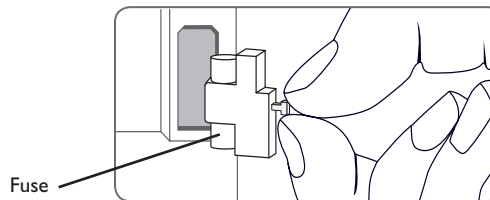

Pump is overheated, but no heat transfer from the collector to the store, flow and return have the same temperature; perhaps also bubbling in the lines.

Air or gas bubbles in the system?

no

yes

Vent the system; increase the system pressure to a static primary pressure of at least plus 0.5 bar; if necessary continue to increase pressure; switch the pump on and off for a short time.

Is the collector circuit blocked at the dirt trap?

yes

Clean dirt trap

Pump starts up very late.

Switch-on temperature difference ΔT_{on} too large?

no

yes

Change ΔT_{on} and ΔT_{off} correspondingly.

Non-ideal position of the collector sensor (e.g. flatscrew sensor instead of sensor in immersion sleeves).

yes

Activate tube collector function if necessary.

o.k.

Pump starts for a short moment, switches off, switches on again, etc.

Temperature difference at the controller too small?

no

yes

Change ΔT_{on} and ΔT_{off} correspondingly.

no

o.k.

Wrong position of collector sensors?

no

yes

Mount the collector sensor at solar flow (warmest collector output); use immersion sleeve of the respective collector.

Plausibility control of the option tube collector special function

The temperature difference between store and collector increases enormously during operation; the collector circuit cannot dissipate the heat.

Collector circuit pump defective?

no

yes

Check/replace it

Heat exchanger calcified?

no

yes

Decalcify it

Heat exchanger blocked?

no

yes

Clean it

Heat exchanger too small?

yes

Replace with correctly sized one.

The solar circuit pump does not work, although the collector is considerably warmer than the store.

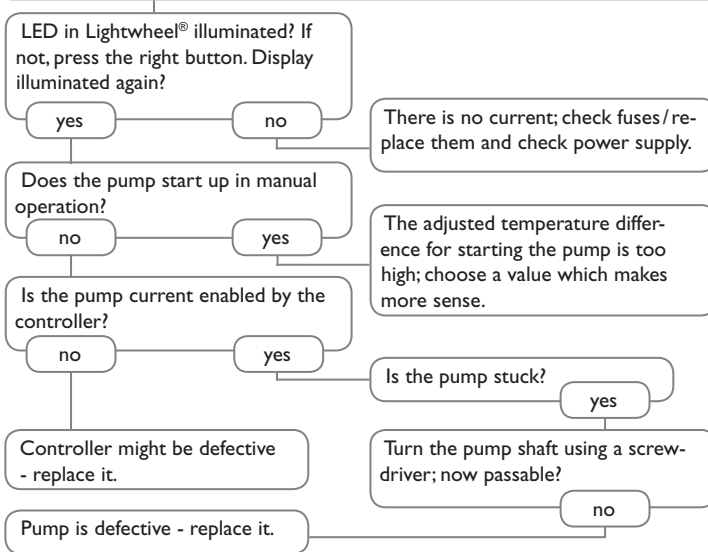

Stores cool down at night.

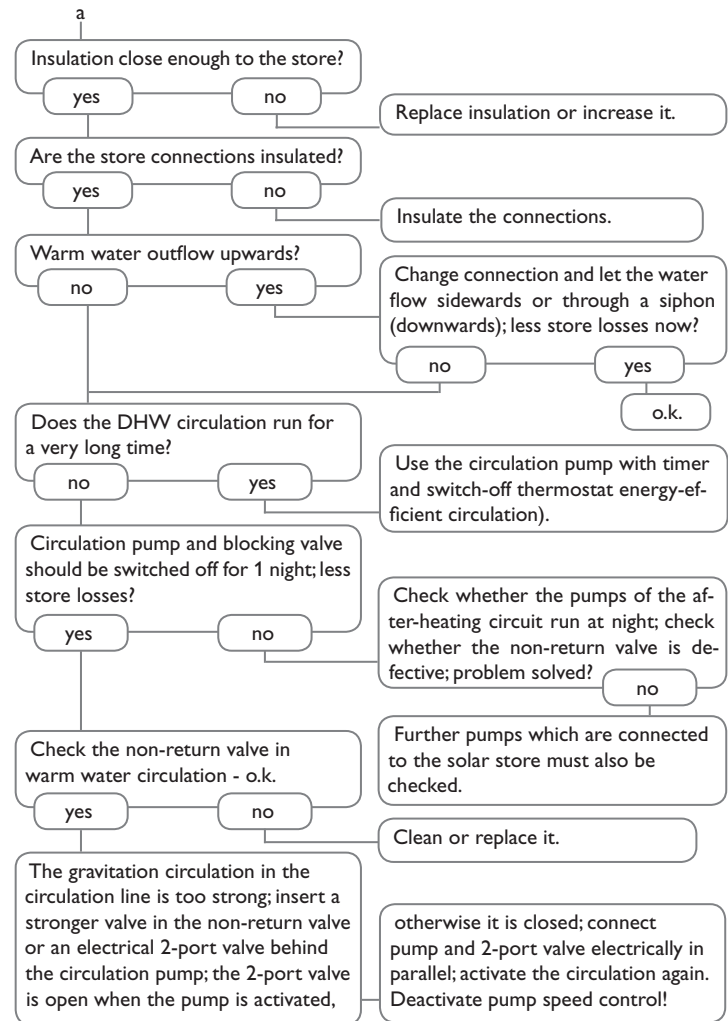
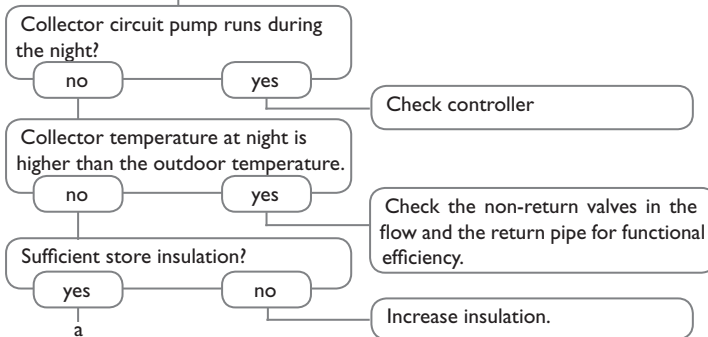

A		
Afterheating.....	40	
B		
Balance values.....	22, 30	
Blocking protection.....	43	
Booster function.....	36	
C		
Code.....	50	
Commissioning.....	23	
Control lamp.....	19	
Cooling function.....	38	
D		
Data communication / Bus.....	6	
Date.....	47	
Displays.....	20	
Drainback option.....	35	
E		
Electrical connection.....	5	
F		
Fault indication.....	21	
Function control.....	48	
H		
Heat dump.....	38	
Heat exchange function.....	40	
Heat quantity measurement.....	46	
HE pump.....	18	
Holiday function.....	42	
L		
Language.....	47	
Legionella protection (thermal disinfection).....	44	
Lightwheel®.....	19	
M		
Manual mode.....	18, 43	
Measurement values.....	22	
Menu overview.....	19, 29	
Messages.....	50	
Microbuttons.....	18	
Minimum and maximum temperatures.....	30	
Monitoring-Display.....	20	
Mounting.....	5	
N		
Night circulation.....	48	
O		
Operating days.....	30	
Option: Thermal disinfection (OTDIS).....	48	
P		
Parallel relay.....	44	
Priority logic.....	32	
R		
Resetting balance values.....	20	
Return preheating.....	41	
S		
Sensors.....	46	
Sensor type.....	46	
Solid fuel boiler.....	39	
Spreaded loading option.....	37	
Store cooling.....	38	
Store sequence control.....	37	
Successive loading option.....	36	
System overview.....	7	
System screen.....	21	
System selection.....	30	
T		
Technical data.....	4	
Temperature differential control (ΔT control).....	31	
Thermal disinfection.....	44	
Thermostat function.....	40	
Time.....	47	
Troubleshooting.....	51	
U		
User code.....	50	

Subject to technical modification without notice.

136954982 01/2019

OVENTROP GmbH & Co. KG
Paul-Oventrop-Straße 1
D-59939 Olsberg
Telephone +49 (0) 29 62 82-0
Fax +49 (0) 29 62 82-400
E-mail mail@oventrop.de
Internet www.oventrop.com

For an overview of our global
presence visit www.oventrop.com.