

#### Tender specification:

Oventrop temperature controllers working without auxiliary energy.

Available with immersion sensor or contact sensor.

For use with two- and three-way valves.

Excess temperature safety: 30 K above the set value.

Higher values are obtained by turning the handgrip to higher figures.

The control range may be limited or locked.

Connection thread M 30 x 1.5.

#### Models:

Temperature controller with immersion sensor  
Immersion pocket G 1/2 connection

Control range	Capillary length	Item no.:
20- 50 °C	2 m	1140561
40- 70 °C	2 m	1140562
50- 80 °C	2 m	1140563
70- 100 °C	2 m	1140564
20- 50 °C	5 m	1140571
40- 70 °C	5 m	1140572
70- 100 °C	5 m	1140574

Temperature controller with contact sensor and heat transfer unit

Control range	Capillary length	Item no.:
20- 50 °C	2 m	1142861
30- 60 °C	2 m	1142862
40- 70 °C	2 m	1142863
50- 80 °C	2 m	1142864

#### Scale: Temperature allocation:

Control range	Handgrip scale						
	1	2	3	4	5	6	7
20-50 °C	approx. 20	approx. 25	approx. 30	approx. 35	approx. 40	approx. 45	approx. 50 °C
30-60 °C	approx. 30	approx. 35	approx. 40	approx. 45	approx. 50	approx. 55	approx. 60 °C
40-70 °C	approx. 40	approx. 45	approx. 50	approx. 55	approx. 60	approx. 65	approx. 70 °C
50-80 °C	approx. 40	approx. 55	approx. 60	approx. 65	approx. 70	approx. 75	approx. 80 °C
70-100 °C	approx. 70	approx. 75	approx. 80	approx. 85	approx. 90	approx. 95	approx. 100 °C

#### Application:

Temperature control for industrial installations, water heaters, counterflow appliances, air heaters, dish washers, oil pre-heaters, dryers, water mixers, condensers, surface heating systems etc. The control range amounts to 30 K, marking on the handgrip: Figures "1" to "7", modification of the nominal value from figure to figure: 5 K.

Mode of operation when used with straight and angle pattern radiator valves DN 15 to DN 32, item no. 118...:

With the temperature at the sensor rising, the valve is closed and with the temperature falling, the valve is opened.

Mode of operation when used with three-way diverting valves "Tri-D TR", item no. 11302...:

With the temperature at the sensor rising, the straight port is closed and the angle port is opened and vice versa.

The angle port is only closed if the nominal value is set at least 10 K above the lower value of the control range (i.e. setting between "3" and "7").

Mode of operation when used with three-way mixing valves "Tri-M TR", item no. 11317...:

With the temperature at the sensor rising, the straight port is opened and the angle port is closed and vice versa.

The straight port is only closed if the nominal value is set at least 10 K above the lower value of the control range (i.e. setting between "3" and "7").

#### Advantages:

- exact control of the set temperature
- constant temperature control
- wide control range
- high excess temperature safety
- simple installation and operation
- reliable functioning
- maintenance-free
- solid design
- wide range of application



Temperature controller with contact sensor and heat transfer unit



Temperature sensor with immersion sensor

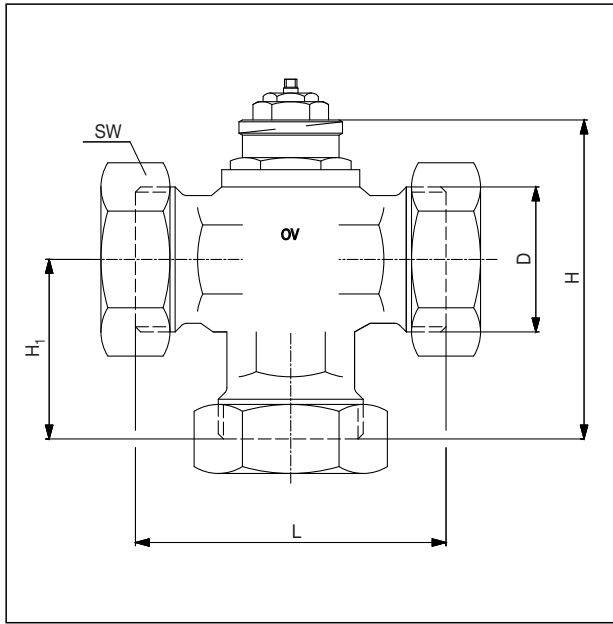

DN	D ISO 228	L	H	H <sub>1</sub>	SW*	Item no.
20	G 1	80	88	47	37	1131706
25	G 1¼	90	91	50	46	1131708
40	G 2	115	106	64	68	1131712

Dimensions three-way mixing valve "Tri-M TR"

\*SW = Spanner size

DN	D ISO 228	L	H	H <sub>1</sub>	SW*	Item no.
20	G 1	80	88	47	37	1130206
25	G 1¼	90	91	50	46	1130208
40	G 2	115	106	64	68	1130212

Dimensions three-way diverting valve "Tri-D TR"

\*SW = Spanner size

**Accessories sets:**

One set includes three tailpipes.

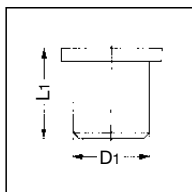

Weldable tailpipes

DN	D <sub>1</sub>	L <sub>1</sub>	Item no.
20	26	50	1130093
25	33	60	1130094
40	48.5	65	1130096

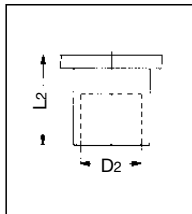

Solder tailpipes

DN	D <sub>2</sub>	L <sub>2</sub>	Item no.
20	15	20	1130192
20	18	23	1130193
20	22	24	1130194
25	28	27	1130195
40	35	40	1130196
40	42	32	1130197

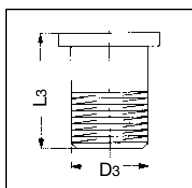

Threaded tailpipes

DN	D <sub>3</sub> EN 10226	L <sub>3</sub>	Item no.
20	R ½	32	1130292
20	R ¾	34	1130293
25	R 1	40	1130294
40	R 1¼	40	1130295
40	R 1½	40	1130296

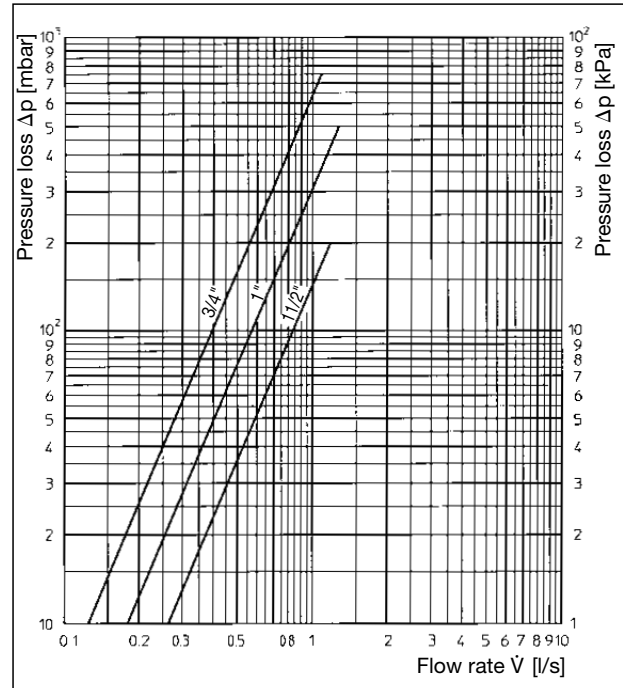

Performance data chart 1

Temperature controllers with three-way mixing and diverting valves, item no. 113....

The total flow rate of the valves is indicated.

Permissible pressure difference: DN 20  $\Delta$  750 mbar, DN 25  $\Delta$  500 mbar, DN 40  $\Delta$  200 mbar (tight closing in final position of the valve disc).

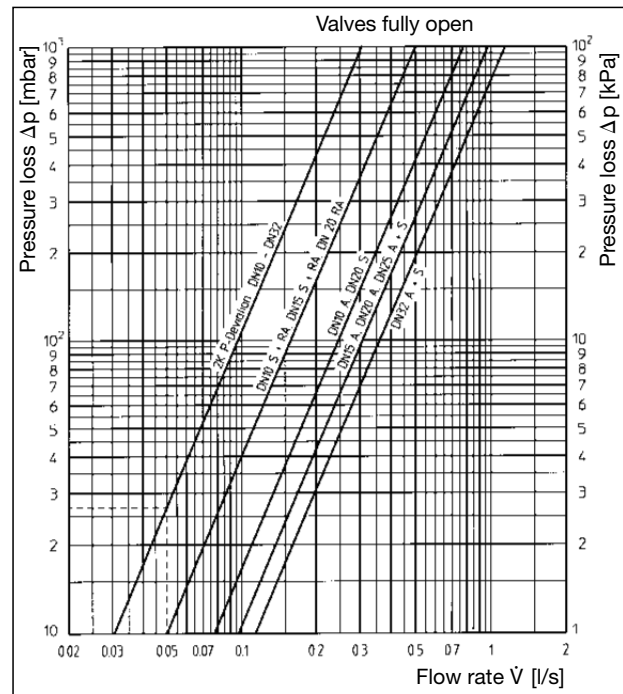

Performance data chart 2

Temperature controllers with angle and straight pattern valves "Series AZ" DN 10 to DN 32, item no. 118....

Max. permissible pressure difference: 1 bar (tight closing of the valve)

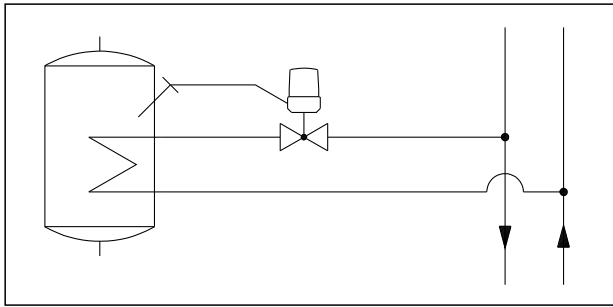

System illustration  
Heating of domestic water with storage cylinder

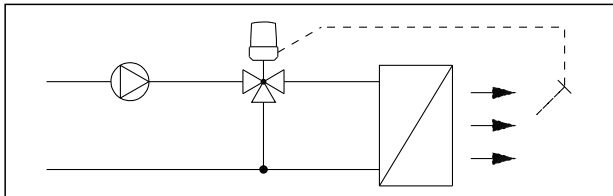

System illustration  
Temperature control in air heaters

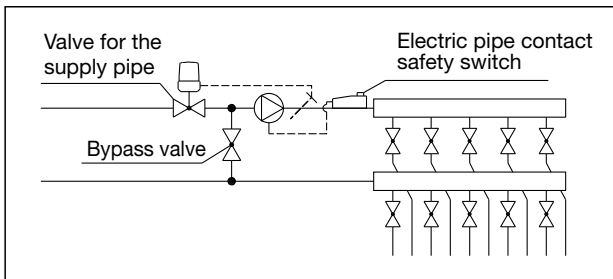

System illustration  
Flow temperature limiting

Installation as flow temperature limiter in combined radiator/surface heating systems. Installation is carried out according to the above drawing. The valve for the supply pipe and the bypass valve have to be co-ordinated.

**Installation:**

The Oventrop temperature controllers are screwed onto the valve. After having installed the immersion pocket at the designated location, the sensor is introduced and fixed with the screw. As for the model with contact sensor and heat transfer unit, the hose clamp supplied with the temperature controller is laid around the pipe. Now the heat transfer unit with the sensor is introduced into the clamp and is fixed with it.

**Regulation:**

Regulation is carried out with the bypass valve in the open position. The required flow temperature is set at the temperature controller. If the flow temperature does not reach the required value, the bypass valve has to be closed step by step until the set value is reached. The electric pipe contact safety switch has to be set to a value approx. 5 K above the nominal value of the temperature controller.

**Presetting of the bypass valves:**

First, the valve is closed with the help of an Allen key and is reopened according to the presetting. The presetting corresponds to the number of turns in opening position.

**Bypass valves:**

Size	Item no.:
DN 15	1027664
DN 20	1027666
DN 25	1027668

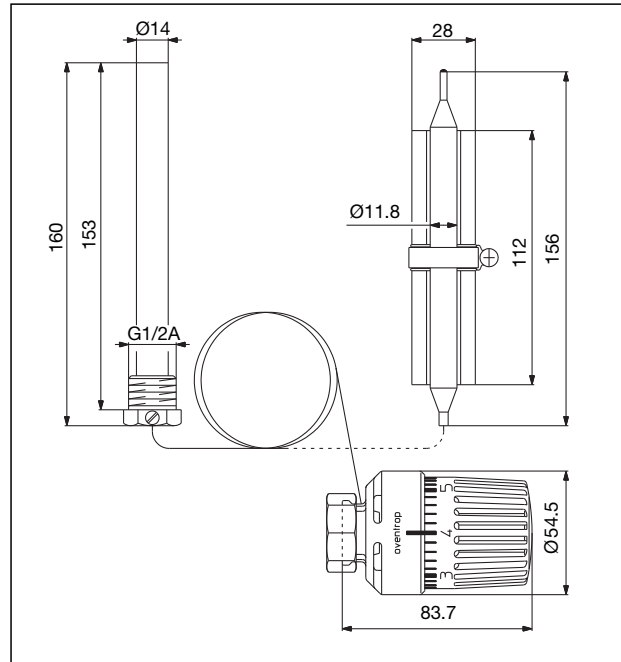

**Dimensions**

Oventrop temperature controller  
with immersion sensor

with contact sensor

**Oventrop valves "Series AZ":**

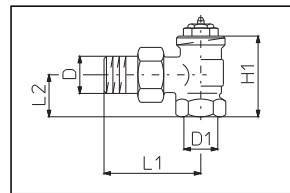

Item no. 11870..

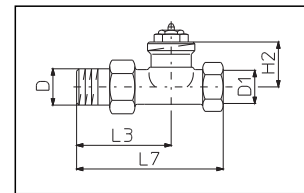

Item no. 11871..

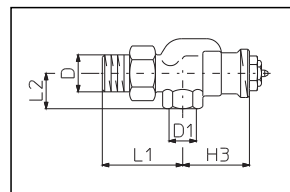

Item no. 11872..

DN	D EN 10226	D <sub>1</sub> EN 10226	H <sub>1</sub>	L <sub>1</sub>	L <sub>2</sub>	k <sub>vs</sub>	Item no.
10	R 3/8	Rp 3/8	47,5	52	22	2.8	1187003
15	R 1/2	Rp 1/2	50	58	26	3.5	1187004
20	R 3/4	Rp 3/4	53	66	29	3.5	1187006
25	R 1	Rp 1	61	75	34	3.5	1187008
32	R 1 1/4	Rp 1 1/4	53	66	29	4.1	1187010

DN	D EN 10226	D <sub>1</sub> EN 10226	H <sub>2</sub>	L <sub>3</sub>	L <sub>4</sub>	k <sub>vs</sub>	Item no.
10	R 3/8	Rp 3/8	28.5	52	85	1.8	1187103
15	R 1/2	Rp 1/2	28.5	59	95	1.8	1187104
20	R 3/4	Rp 3/4	28.5	63	106	2.8	1187106
25	R 1	Rp 1	28.5	80	125	3.5	1187108
32	R 1 1/4	Rp 1 1/4	33.5	90	150	4.1	1187110

DN	D EN 10226	D <sub>1</sub> EN 10226	H <sub>3</sub>	L <sub>1</sub>	L <sub>2</sub>	k <sub>vs</sub>	Item no.
10	R 3/8	Rp 3/8	41.5	52	22	1.8	1187203
15	R 1/2	Rp 1/2	40	58	26	1.8	1187204
20	R 3/4	Rp 3/4	37	66	29	1.8	1187206

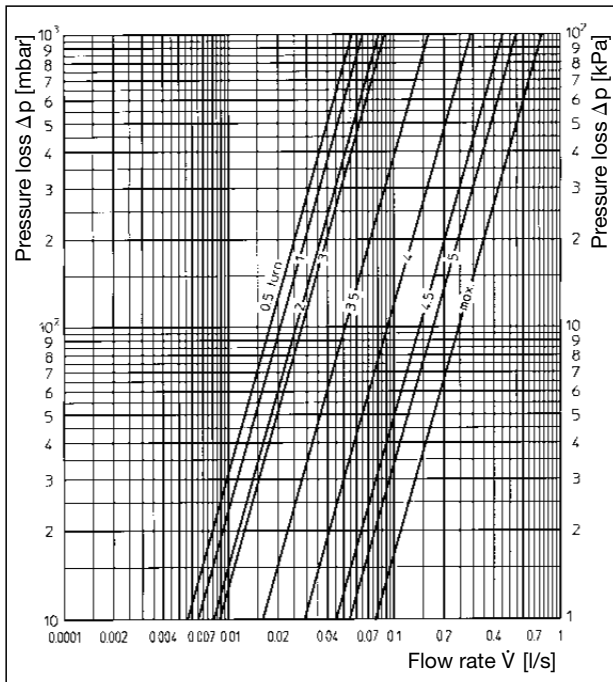

Performance data chart 3  
Bypass valves DN 15, DN 20,  
item no. 1027664, 1027666

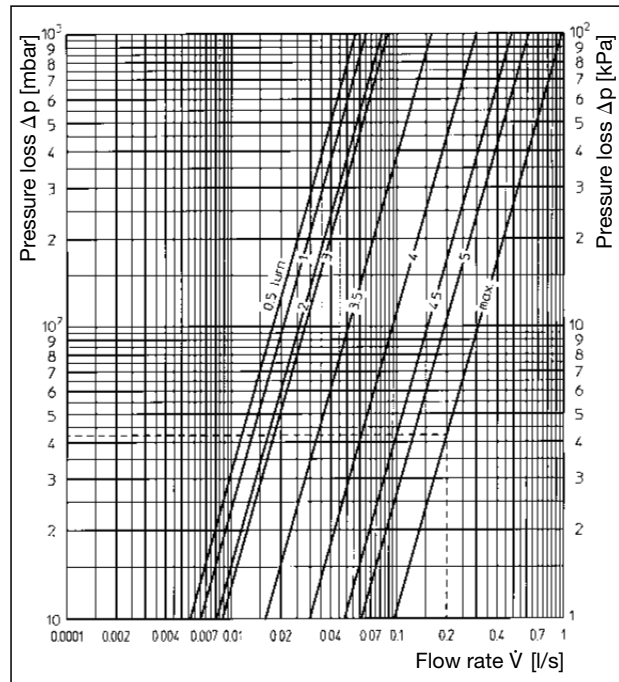

Performance data chart 3  
Bypass valve DN 25  
item no. 1027668

**Example:**

Given:

Floor surface	A = 90 m <sup>2</sup>
Heat demand including floor loss	P = 6300 W
Flow temperature of the surface heating circuit	46 °C
Return temperature of the surface heating circuit	38 °C
Temperature difference of the surface heating circuit	$\Delta t_1 = 32\text{K (70/38 °C)}$
	$\Delta t_2 = 8\text{ K (46/38 °C)}$
Flow temperature of the heating circuit	$t_v = 70\text{ °C}$

Solution:

Pressure loss of the straight pattern valve:

$$\text{Flow rate } V = c \cdot \frac{P}{\Delta t_1} \cdot \frac{0.86}{3,600} \cdot \frac{6,800}{32} \text{ l/s} = 0.05 \text{ l/s}$$

Pressure loss  $\Delta p = 2.7 \text{ kPa}$  (taken from chart 2, dotted lines), with 2 K P-deviation.

Pressure loss of the bypass valve:

$$\text{Flow rate } V = c \cdot \frac{P}{\Delta t_2} \cdot \frac{0.86}{3,600} \cdot \frac{6,800}{8} \text{ l/s} = 0.2 \text{ l/s}$$

Pressure loss  $\Delta p = 4.2 \text{ kPa}$  (taken from chart 3, dotted lines), bypass valve completely open.

Subject to technical modification without notice.

Product range 3  
ti 89-EN/10/MW  
Edition 2015

OVENTROP GmbH & Co. KG  
Paul-Oventrop-Straße 1  
D-59939 Olsberg, Germany  
Phone +49 (0)29 62 82-0  
Fax +49 (0)29 62 82-450  
E-Mail mail@oventrop.de  
Internet www.oventrop.de

For an overview of our global presence  
visit [www.oventrop.de](http://www.oventrop.de).