

ASSEMBLY AND OPERATION MANUAL

Microprocessor-controlled control unit for solar thermal systems:

Oventrop REGTRONIC PC

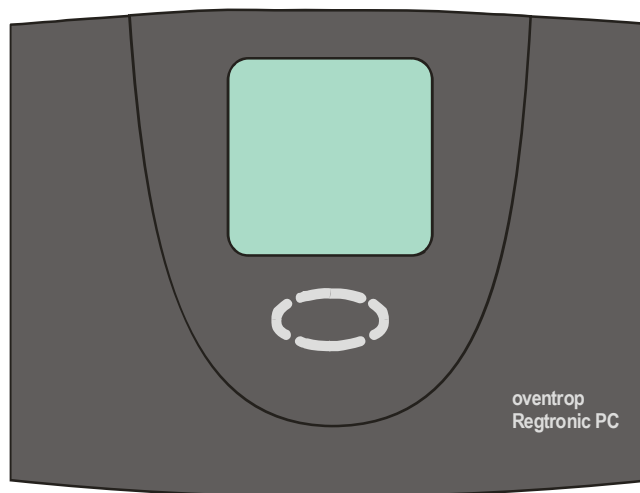

Important!

Please read the instructions carefully before installing and operating the unit!

Failure to do this can void product warranty!
Please keep the instructions in a safe place!

This unit described has been manufactured and inspected according to CE regulations.

Table of Contents:

1 SYMBOLS AND ABBREVIATIONS.....3

2 USAGE SCENARIO / FEATURES.....4

 2.1 BASIC INFORMATION4

 2.2 USAGE SCENARIO4

 2.3 UNIT FEATURES4

3 SAFETY ADVICE5

4 UNIT INSTALLATION6

 4.1 OPENING THE UNIT.....6

 4.2 WALL INSTALLATION.....6

5 ELECTRICAL CONNECTIONS – OVERVIEW7

 5.1 GENERAL CONNECTION GUIDELINES:.....8

 5.2 230 V CONNECTORS8

 5.3 CONNECTING SENSORS.....9

 5.4 SURGE PROTECTION MODULE9

6 OPERATION / DISPLAY10

 6.1 OVERVIEW OF DISPLAY AND CONTROL BUTTONS10

 6.2 SCREEN11

 6.3 EXPLANATION OF ICONS11

 6.4 BUTTON FUNCTIONS.....12

 6.5 CONTROL UNIT USAGE EXAMPLE13

 6.5.1 *Changing Target dTon temperature.....13*

 6.5.2 *Configuring a multi-function regulator.....15*

7 USER MENUS20

 7.1 OVERVIEW: MENU LAYOUT.....21

 7.2 "INFO" MENU 21

 7.3 "PROGRAMMING" MENU 21

 7.4 "MANUAL OPERATION" MENU 22

 7.5 "SYSTEM SETTINGS" MENU 22

8 CONTROL UNIT FUNCTIONS.....23

9 DATA INTERFACE - DATASTICK®23

 9.1 DATASTICK®23

 9.2 DATA LOGGING23

10 TROUBLESHOOTING.....25

 10.1 REPORTABLE FAULTS.....25

 10.2 NON-REPORTABLE FAULTS26



11 TECHNICAL DATA27

12 PT1000 RESISTANCE TABLE27

13 DECLARATION OF CONFORMITY.....28

1 SYMBOLS AND ABBREVIATIONS

Explanation of the icons used in this Operation Manual:

	Warning! Icon indicates possibility of hazard or error
	Warning: 230 V current! Icon indicates danger from high-voltage, life-threatening current.
•	List
	Please note!
i	Operational advice / special information
→	User action / procedure
?	Inspection / check

Frequently-used abbreviations

Abbreviations and symbols are sometimes used to improve legibility in this documentation and on the display of the control unit itself. Their meanings are presented in the following table.

Abbrevia- tion	Meaning	Abbre- viation	Meaning
Start	Initial value	°C	Degrees Celsius
Stop	Final value	h	Operating hours
>	Larger than	dT	Temperature difference
K	Degrees Kelvin, equates to 1 degree of temperature difference	kWh	Energy output in kWh

2 USAGE SCENARIO / FEATURES

2.1 Basic information

The controller is designed as a system control unit, i.e. it is suitable for a variety of systems, depending on the functional layout and options selected.

The description given below therefore refers to the general functionality of the controller.

The various functional layouts and corresponding connection diagrams are described in separate documents.

Since the controller can be used in many different ways, it is important that you read the Operation Manual before connecting and starting up the unit!

2.2 Usage scenario

The controller is used to control the functionality of solar thermal plant by providing ancillary and protective features.

The controller is designed to be used in dry areas such as residential, office and commercial interiors.

If you want to use the unit for other purposes, check applicable statutory regulations before use.

2.3 Unit features

The control unit can be used with many types of system.

Independently of the specific usage scenario, the unit has the following standard features:

- **Easy, menu-driven operation** using icons, simple text messages and four control buttons.
- All presets and control values **can be set digitally**
- Integrated **operating hours counter** for memory loading
- Powerful **system monitoring** functionality, with errors and faults displayed using icons and simple text
- Integrated **energy output measurement**: the output measurement set (optional accessory) can be used to record the energy produced by the solar plant

- Indefinite storage of all configured values if power supply fails.
- A variety of **protective features**, such as:
 - System protection
 - Collector protection
 - Recooling
 - Frost protection
- DataStick® interface

A DataStick® (optional accessory) provides a simple way to carry out data logging.

Available accessories (optional):

- PT1000 temperature sensor
- Flow transmitters for output measurement
- Radiation sensors

3 SAFETY ADVICE





You must isolate the control unit from mains power before carrying out any assembly or connection work. The installation and start-up of the control unit should only be carried out by qualified technical personnel. All work must comply with the applicable national and local safety regulations.

 Always ensure that you isolate the equipment from mains power before starting installation or connection work on the unit's electrical components. Make sure that you never confuse the SELV (safety extra low voltage) connectors (sensors, flow transmitters) with the 230 V connectors. This may produce life-threatening current and cause irreparable damage to the device, attached sensors and equipment.

 Solar power systems can generate high temperatures. There is therefore a risk of burn injuries! Exercise caution when installing the temperature sensors!

 When installing sensors, avoid locations (such as heat sources) that generate temperatures outside the equipment's maximum range (>50 °C).

 The control unit is not splash- or drip-proof. Ensure that it is installed in a dry place.

 For safety reasons, the system should only be operated manually during testing. In this operating mode, the system does not monitor maximum temperatures or sensor functions.

 Do not operate the system if there is recognisable damage to the controller, cables or the connected pumps and valves.

 Before using piping or installation materials, or attaching pumps and valves, check that these are suitable for the temperature levels generated by the system.

4 UNIT INSTALLATION



Only install the control unit in dry interiors not subject to a risk of explosions. Do not install the unit onto flammable surfaces.

4.1 Opening the unit

Before opening, ensure the unit is isolated from mains power. The upper part of the housing is locked to the lower part using two latches. You can release the top of the cas-

ing by pulling gently on the sides of the cover (see picture) and then pivoting the cover upwards.

Continue to pull the cover upwards until it snaps into place. This will enable you to easily install and connect up the control unit



Before switching on or starting up the system: ensure that you have closed the cover – you must be able to hear and feel it snap into place!

4.2 Wall installation

If mounting the unit on a wall, proceed as follows:

- Drill the mounting holes to match the drilling template provided
- Screw in the two upper screws so that they project 6 mm from the wall
- Open the unit as described above and hang it on to these two screws. You can now screw in the two lower screws.
- Tighten all screws only as much as necessary, to avoid damaging the lower part of the unit casing!

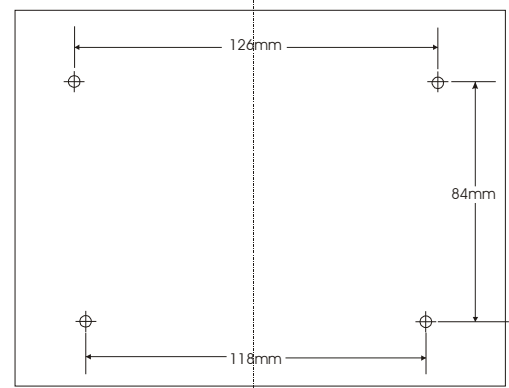

5 ELECTRICAL CONNECTIONS – OVERVIEW



Please ensure that you follow the safety advice given in Section 3

Only open the unit once you have ensured that it has been isolated from mains power and cannot be switched on by accident.



Before switching on or starting up the system: ensure that you have closed the cover – you must be able to hear and feel it snap into place!

All electrical connections are made to the subassembly in the lower part of the unit. (SELV) connectors for sensors and flow transmitters are located on the right-hand side of the subassembly. The 230 V connectors are located on the left-hand side.

The number and location of 230 V and sensor connectors is described on the data sheet corresponding to the layout used.

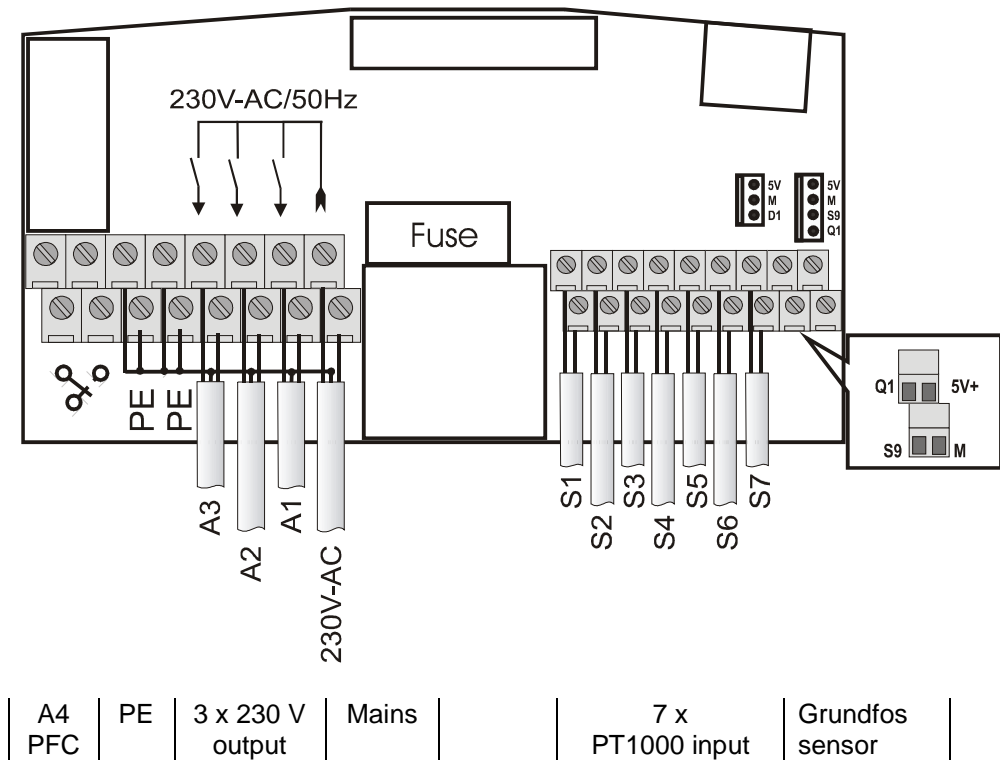



5.1 General connection guidelines:

- When connecting all cables, strip the cable covering to a length of approx. 6-8 cm and the wires to a length of approx. 10 mm.
- For flexible cables, a strain relief device must be present on the interior or exterior of the unit. On the 230 V side, this can be done by mounting a max. of 4 M12 cable screws. The ends of the wires must be covered with wire end ferrules. The cables are fed through the apertures provided and attached to the unit.
- All earth leads must be attached to the terminals marked "PE" (potential earth).

5.2 230 V connectors

One mains power connector is provided, plus a total of 6 230 V/50 Hz outputs.

 If the control unit is wired directly into the mains, it must be possible to isolate mains power by using a switch external to the unit. If the unit is connected using a cable and earthed plug, this switch is not necessary.

 The control unit is designed for use with 230 V/50 Hz mains power. Any pumps and valves to be connected must also be rated for use at this voltage!

i The neutral lead terminals (N) are connected electrically and are not switched!

i All switched outputs (A1 to A3) are electronic 230 V AC N/O contacts.

Bear in mind the following points concerning the 230 V connections:

i Depending on the functional layout used, all outputs can be used as switched outputs or – using block modulation – as pump power controls.

i All output activity is monitored electronically. A functional check is made automatically once a day, and can also be started manually from the Manual Operation menu.

i If the functional check fails, then this will close a potential-free contact (A4).

5.3 Connecting sensors

The control unit works with high-precision platinum PT1000 temperature sensors. Between 2 and 7 sensors will be needed, depending on the system setup and functional layout. In some layouts, flow transmitters will need to be connected.

Mounting / wiring the temperature sensors:

- Mount the sensors in the corresponding places on the collector and storage tank. Ensure proper heat transfer, using heat-conductive paste if necessary.
 - The temperature sensor cabling can be extended if required. Cross-sections required: lengths up to 15 m, 2 x 0.5 mm²; lengths up to 50 m, 2 x 0.75 mm². Use shielded extension cables for long connections (e.g. to collector).
- Do not insert shielded cable on the sensor side – clip it and strip it!
 - Temperature sensors are connected according to the system setup. You do not need to observe polarity for the two wires when cabling temperature sensors.
 - ☞ When laying sensor cabling, keep it away from 230 V cables: these can be a source of electrical interference under adverse conditions. Keep cabling at least 15 cm apart.

5.4 Surge protection module



The control unit is provided with fine-level surge protection for all sensor inputs. As a rule, you will not need to take additional precautions for interior sensors. However, we recommend additional protection for collector sensors and exterior sensors (sensor connection box with surge protection). Exterior protective devices must not contain any additional capacitors, since these may distort measurement readings.

6 OPERATION / DISPLAY

6.1 Overview of display and control buttons

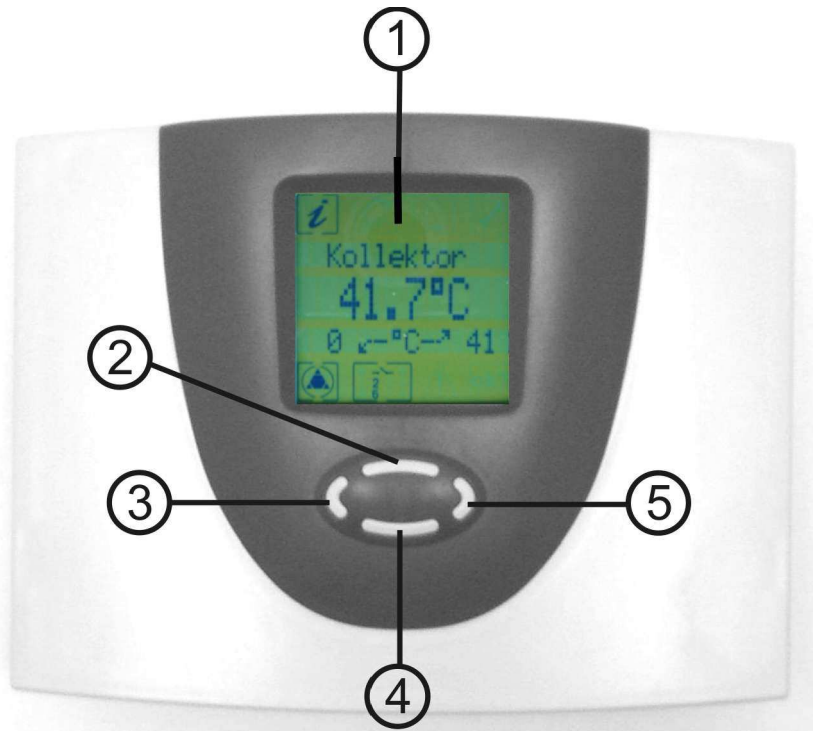

Number	Description
1	Screen with graphical icons and 3-line simple text display
2	Page up / + control button
3	Exit / Cancel / ESC control button
4	Page down / - control button
5	Select / Confirm / Enter control button

6.2 Screen

The screen displays graphical icons and simple text messages. The three-line simple text display is used to show display and programming values, relating these to measuring points.

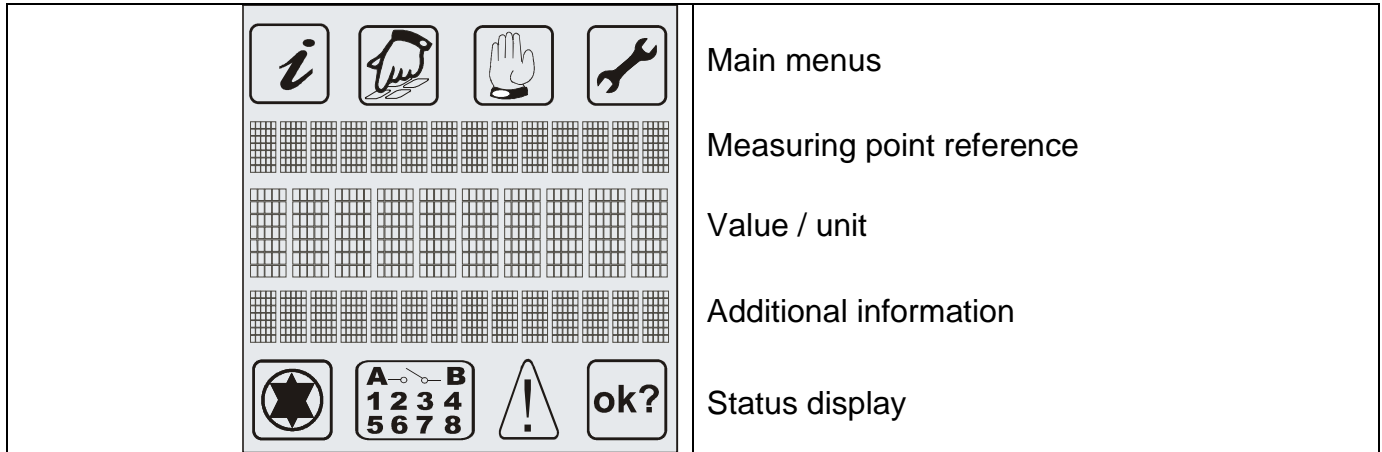

6.3 Explanation of icons

The following table describes the meanings of the various icons used.

Icon	Description	Display during operation
Main menu		
	"Info" menu	Icon flashes if selectable. Select with button If only one icon is displayed, this menu is active
	"Programming" menu	
	"Manual operation" menu	
	"System Settings" menu	
Status display		
	Regulator active	Icon rotates if solar circuit pump is switched on
	Displays active switched outputs	Numbers of active switched outputs
	Indicates a system error	Display flashes if an error occurs in the system
	Used to confirm the saving of changed values	Value displayed can be rejected or confirmed





6.4 Button functions

The control unit can be operated simply and easily with the 4 control buttons. You can use the control buttons to:

- Access display values
- Make changes to unit settings

The icons used for the display guide you quickly through the various options, clearly showing the current menu selection, reading or parameter.

The control buttons have the following functions:









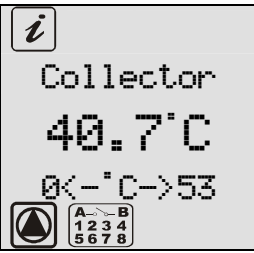

Button	Function	Description
	"Up" „+“	<ul style="list-style-type: none"> • Page up in the menu • Value modification: stepwise increase of the value displayed If the button is pressed and held, values increase continuously
	"Access" "Down" „-“	<ul style="list-style-type: none"> • On the start screen: accesses a main menu • Page back in the menu • Value modification: stepwise decrease of the value displayed If the button is pressed and held, values decrease continuously
	"Page left" "Exit" "Cancel"	<ul style="list-style-type: none"> • IPage left in a main menu • Exit a menu • Exit a menu item • Cancel a value change without saving it
	"Page right" "Select" "Confirm"	<ul style="list-style-type: none"> • IPage right in a main menu • Select a menu item • Confirm a value change and save it















6.5 Control unit usage example

6.5.1 Changing Target dTon temperature





Once you have made yourself familiar with the descriptions of the menus in the "User menus" section, you can proceed by making some operational changes. The example below describes one such operational procedure. The starting point here is the "Info"





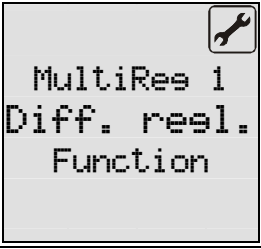

menu, showing the current collector temperature. Objective: Change the parameter "Target dTon" from 7 K to 5 K, using the "Programming" menu.

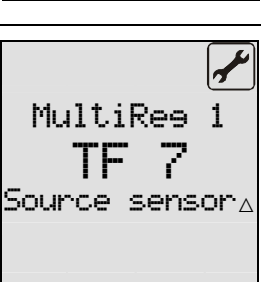





		<p>Escape: Exit the "Info" menu</p>
		<p>Page right: Select "Programming" menu</p>
	 	<p>Select "Programming" menu In the "Programming" menu, page until the submenu "Storage tank" is shown.</p>
		<p>Select submenu "Storage tank"</p>
		<p>In the submenu, page until the value "Target dTon" is shown.</p>









 Storage tank 7 K Target dTon		Select value: the value "Target dTon" now begins to flash
 Storage tank 5 K Target dTon	 	Decrease the value until the chosen value is selected. Value continues to flash. Select "Confirm value"
 Storage tank 5 K Target dTon 	 or 	Icon  flashes. Confirm the change. Change is applied. Leave value as-is: change is not applied
    Flashes 12:09:24	2 x 	Exit submenu "Storage tank" Exit "Programming" menu



6.5.2 Configuring a multi-function regulator

 <p>MultiRes 1 [off]</p>	<p>Select the multi-function regulator (MFR for short) you want in the "System Settings" menu. Factory setting: MFR = Off</p>
 <p>MultiRes 1 Off Function</p>	<p>Select (activate) the submenu of the selected MFR. Function is "Off", i.e. no regulator functionality is currently active.</p>
 <p>MultiRes 1 Diff. reel. Function</p>	<p>Select the specific MFR function to use. For this example we will use a difference regulator. Available functions: thermostat cooling, thermostat heating, threshold switch, increased return flow, wood boiler, difference regulator, circulation, alarm and timer</p>
 <p>MultiRes 1 Off Time frame</p>	<p>The MFR's functionality can be linked to specific time frames. "Off": No time frame active MFR function = continuously active</p>
 <p>MultiRes 1 On Time frame</p>	<p>Time frame linking is active, i.e. the selected function cannot be activated continuously, but is time-limited and only works within the specified time frame.</p>
 <p>MultiRes 1 TF 7 Source sensorΔ</p>	<p>Selects the temperature sensor for the energy source. (Any available temperature sensor can be selected, even if it is currently being used by another function.)</p>

 <p>MultiRes 1 TF 8 Sink sensor ▾</p>	<p>Selects the temperature sensor for the energy sink. (Any available temperature sensor can be selected, even if it is currently being used by another function.)</p>
 <p>MultiRes 1 None Link type</p>	<p>Theoretically, each MFR can be linked to other outputs – i.e. the status (active, inactive) of another output chosen by the user influences the control process of the current MFR</p>
 <p>MultiRes 1 Los.AND Link type</p>	<p>Select the link usage logic. "AND": the output is only on if A1 to A7 also fulfil these conditions and the switch-on conditions for MultiReg 1 are also met</p>
 <p>MultiRes 1 XX010X1 Link A1-A7</p>	<p>Select the output usage logic AND: MultiReg 1 (A6) is only on if: <ol style="list-style-type: none"> 1. Its switch-on conditions are met AND 2. A4, A7 are on (1) and A3, A5 are off (0). A1 and A2 are not considered in this scenario (X) Note: The user's output (here: A6) cannot be edited</p>
 <p>MultiRes 1 Los.OR Link type</p>	<p>Select the link usage logic. "OR": the output is only on if at least one of the conditions are fulfilled – including the switch-on conditions for MultiReg 1</p>
 <p>MultiRes 1 XX010X1 Link A1-A7</p>	<p>Select the output usage logic OR: MultiReg 1 (A6) is only on if: <ol style="list-style-type: none"> 1. Its switch-on conditions are met AND 2. A4 or A7 is on (1), or A3 or A5 is off (0). A1 and A2 are not considered in this scenario (X) Note: The user's output (here: A6) cannot be edited</p>
 <p>MultiRes 1 [on] Diff. reel.</p>	<p>Exit the submenu MFR1 in the "System Settings" menu. The activated function is shown as text on the screen.</p>

Corresponding settings in the "Programming" menu	
 <p>MultiRes 1 [Values] Diff. resl.</p>	<p>The MFR1 is configured in the "Programming" menu by selecting the submenu MFR1</p>
 <p>Diff. resl. 65°C maximum</p>	<p>Limiting the maximum temperature of the energy sink, e.g. for the storage tank accepting energy. The function is switched off once the energy sink sensor reaches the switch-off temperature.</p>
 <p>Diff. resl. 15°C minimum</p>	<p>Limiting the minimum temperature of the energy source, e.g. for the storage tank releasing energy. The function is only switched on once the energy source sensor reaches the switch-on temperature – in addition to the temperature difference required between the energy source and sink.</p>
 <p>Diff. resl. 7 K dTmax</p>	<p>Switch-on difference between energy source and energy sink.</p>
 <p>Diff. resl. 3 K dTmin</p>	<p>Switch-off difference between energy source and energy sink.</p>
 <p>Diff. resl. 0:00 Time 1: Start</p>	<p>Start time of the 1st time frame for the MFR.</p>

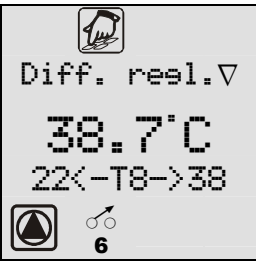
 <p>Diff. reel. 23:59 Time 1: Stop</p>	<p>Stop time of the 1st time frame for the MFR.</p> <p>Defining a timeframe from 0:00 to 23:59 means the function will be permanently activated.</p>
 <p>Diff. reel. 12:00 Time 2: Start</p>	<p>Start time of the 2nd time frame for the MFR.</p>
 <p>Diff. reel. 12:00 Time 1: Start</p>	<p>Stop time of the 2nd time frame for the MFR.</p> <p>If the start time and stop time of a time frame are identical, this time frame will be deactivated, i.e. will not be taken into account.</p>
 <p>Diff. reel. 18:00 Time 3: Start</p>	<p>Start time of the 3rd time frame for the MFR.</p>
 <p>Diff. reel. TROL 18:00 Time 3: Stop</p>	<p>Stop time of the 3rd time frame for the MFR.</p> <p>Time frame is also deactivated.</p>
<p>Corresponding display in the "Info" menu</p>	
 <p>Diff. reel. Δ 56.4°C 45<-T7->56</p>  	<p>Display of the temperature of the energy source sensor in the "Information" menu, with minimum and maximum values. The corresponding measuring point – here T7 – is also displayed.</p>

	<p>Display of the temperature of the energy sink sensor in the "Information" menu, with minimum and maximum values. The corresponding measuring point – here T8 – is also displayed.</p>
	<p>Display of the functional status in the "Information" menu. The 3rd line displayed on the screen shows the active ancillary features – here "Diff. regl.".</p>

7 USER MENUS





To make it as easy as possible to operate the unit, the device, user and display functions have been placed into 4 groups (i.e. main menus).

Depending on the system setup and ancillary features selected, submenus will also be available within these main menus.

The four menus

- Info
- Programming

- Manual Operation
 - System Settings
- will either display information about your solar system or will let you enter system parameters.
- The menu currently active is indicated by the corresponding icon displayed in the top row of the screen.

Menu	Overview of available functions
Info 	Main menu for automated control of the solar system. <ul style="list-style-type: none"> • Displays current readings • Displays the system status • Displays error messages • Displays hours of operation and energy yield(if available)
Programming 	Alteration/configuration of programmable settings (parameters) Caution: Changes can compromise system functionality
Manual Operation 	Manual activation and deactivation of attached pumps / valves
System Settings 	Information about basic settings controlling system functionality. End users can view – but not change – these parameters. Please note: Settings and changes here should only be carried out by technicians! Available submenus, depending on the unit model: <ul style="list-style-type: none"> ▪ Select basic layout ▪ Select language ▪ Collector protection ▪ Recooling ▪ System protection ▪ Frost protection ▪ Type 1..2 tube collector feature ▪ Yield measurement Multi-function regulator <ul style="list-style-type: none"> ▪ Heating ▪ Cooling ▪ Threshold switch ▪ Increased return flow ▪ Wood boiler feature ▪ Difference regulator ▪ Circulation ▪ Alarm ▪ Timer

7.1 Overview: menu layout



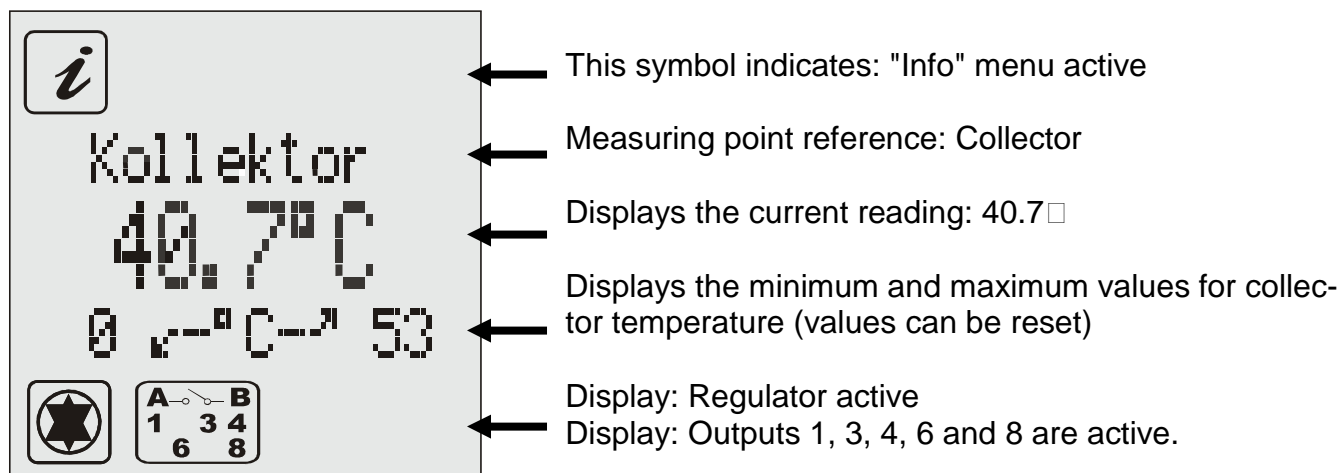

7.2 "Info" menu

The "Info" menu displays all of the readings and operational status values. Sample screen display from the "Info" menu:



i Note that only the regulator-specific values and those values required for the activated ancillary features are shown!

If values can be reset, then they can be reset as follows:

- ➔ Select the value you want, using buttons  and 
- ➔ To reset the value, use button 
- ➔ Confirm message "OK?", using  for "No" or  for "Yes"

7.3 "Programming" menu

This menu can be used to check and change all configurable parameters. As a rule, the factory settings generally configure the parameters so as to guarantee the smooth operation of the system.

The number of values displayed depends on the unit type and the ancillary features configured. Only the values required for the unit are displayed.

Complex system set-ups need many parameters to be programmed. To keep the operation of the unit as simple as possible, these parameters have been grouped into submenus. The submenus available depend on the system layout selected and the active ancillary features configured.

7.4 "Manual Operation" menu

The solar power system can be operated manually for servicing and testing. This also lets you switch on/off the 230 V switched outputs. No automated control of the system is available during manual operation. To prevent system instability, the system switches back to "Display" mode after approx. 8 hours in manual mode, re-activating automated control. The option "Follow-on manual" can be used

to set manual operation for a set period. During this period, you can exit from the "Manual Operation" menu and carry out servicing or testing. Any values set in the menu will stay in force for this period of time, letting you use the "Info" menu to view and monitor readings and the system status.



7.5 "System Settings" menu





Parameters set in this menu should only be configured or modified by installers or qualified technical personnel. Setting the wrong parameters can compromise the functionality of the control unit and solar system.

During normal operation, the "System Settings" menu only displays parameters and does not allow them to be altered. This prevents accidental changes. **To change parameters, this menu must be selected within one minute of switching on the unit.**

The System Settings menu "locks" itself automatically one minute after the unit has been switched on and one minute after the user has exited the menu.

While the system is running, changes can be made using the System Settings menu by pressing the top , bottom  and right-hand  button simultaneously. Once the user is in the menu, no time limits apply.

The System Settings menu is used to select the basic schema and the language, and also to activate or deactivate the available protective and ancillary features. The buttons  and  are used to page through the various submenus. The status – e.g. "On" or "Off" – is also shown next to the name of each submenu. Submenus are selected by using the  button.

Allocation of layout no. to system number: PC0 = 3330, PC1 = 3331, PC2 = 3332, PC3 = 3333, PC4 = 3334.

Note: 3300 is the initial software set!

Example: change system from 3300 to 3331

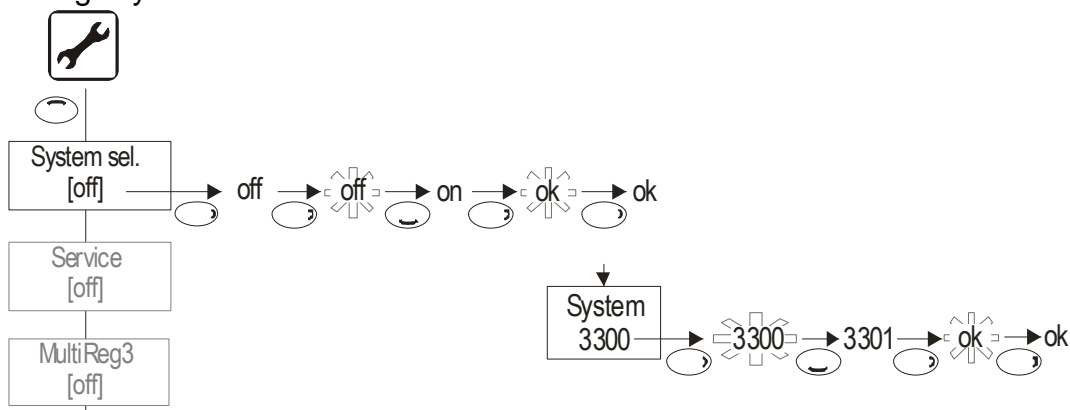

8 CONTROL UNIT FUNCTIONS

The control unit is equipped with a wide range of functions for controlling and monitoring the solar power system. These functions can be classified as follows:

- Control functions for charging the storage tank
- Functions for protecting and monitoring the system
- Ancillary features

The "Control unit functions" document describes the control unit functions available.

The unit functions available depend on the system software and the basic layout selected. These functions are described in the instructions provided for the basic layouts.

9 DATA INTERFACE - DATASTICK®

The control unit is equipped with an innovative data interface. This interface enables the following optional functions:

- Data logging (with DataStick®)
- Remote system monitoring (with modem package)

These functions are optional. To use them, you will need extra accessories (not supplied with the unit) such as a DataStick or modem!

9.1 DataStick®

A DataStick® provides a simple way to carry out data exchange between the control unit and a PC. The system has the advantage that the PC does not need to be connected to the control unit itself, meaning that even a desktop PC can be used. Data is stored indefinitely on the DataStick® – even without power.

- The DataStick® can be connected or disconnected to the port on the top of the unit without disturbing unit functionality; no special tools are required.

9.2 Data logging

By using a DataStick®, all system status, measurement and error message data can be recorded at intervals of 1-30 minutes (configurable) and then transferred to a standard PC. Each data record also contains the date and time of day.

Over 16,000 data records can be saved to the DataStick®.

Recording times depend on the configured recording interval, as follows:

Interval	Approx. max. time
1 minute	11 days
5 minutes	55 days
30 minutes	350 days

The recording function starts automatically once the DataStick® is inserted.

Parameters are stored on the DataStick® itself and can be modified as needed using "Data logging" on the "Programming" menu:

- Recording interval configuration
- Selection of simple recording (storage medium is written to until full) or cyclical recording (old data is overwritten)
- Reset logging storage (any data present is deleted, unit reboots)
-

Accessories required:

- PC software for evaluating the data recorded
- PC interface adapter for the USB port
- SOLAREG® DataStick®

10 TROUBLESHOOTING







In principle, all system errors can be placed in one of two categories:

- faults that are recognised by the control unit itself, and which it can therefore report

The symbol  functions as a general error indicator.

- Faults that cannot be reported by the controller

10.1 Reportable faults



Error displayed on-screen	Possible causes	Action to take
  flashing	<ul style="list-style-type: none"> • Disruption to sensor cable • Sensor defective 	→ Check cable → Check sensor resistance, replace sensor if necessary
  flashing	<ul style="list-style-type: none"> • Short-circuit in sensor cable • Sensor defective 	→ Check cable → Check sensor resistance, replace if necessary
Circulation fault: no flow-through  +  flashing Also displayed with energy yield measure- ment: 	<ul style="list-style-type: none"> • Fault in pump connection • Pump defective • Air in the system • Flow meter defective • Connection to flow meter defective • Disruption to sensor cable • Sensor defective 	→ Check cabling → Replace pump → Vent system → If visible, check whether the fly-wheel of the meter moves when the system is running → Check cable → Check cable → Check sensor resistance, replace sensor if necessary

10.2 Non-reportable faults

For faults and malfunctions that cannot be displayed, you can use the following table to identify them, plus evaluate the possible causes and sources of such errors. If you

cannot rectify the fault by using the description below, you will need to contact your supplier or installer.

	Important: any faults involving the 230 V/AC mains power supply must only be rectified by a technician!
---	--

Error display	Possible causes	Action to take
No display possible 	<ul style="list-style-type: none"> • 230 V mains power supply unavailable 	<ul style="list-style-type: none"> → Switch on or connect up control unit → Check fuses for building power supply
	<ul style="list-style-type: none"> • Fuse inside unit defective 	<ul style="list-style-type: none"> → Check fuse, replace if necessary with new 2A (T) fuse. → Check 230 V components for short-circuits
Control unit inoperative	<ul style="list-style-type: none"> • Unit defective • Unit is in manual operation mode • Switch-on condition not yet achieved. 	<ul style="list-style-type: none"> → Contact your supplier → Exit "Manual Operation" menu. → Wait until switch-on condition achieved
"Pump" icon turns, but pump is not working 	<ul style="list-style-type: none"> • Disruption to pump connection. • Pump has seized up. • Switched output has no current. 	<ul style="list-style-type: none"> → Check cable to pump → Ensure pump can run smoothly → Contact your supplier.
Temperature display fluctuates strongly at short intervals	<ul style="list-style-type: none"> • Sensor cabling has been laid near to 230 V cables • Long sensor cables extended using unshielded leads • Unit defective 	<ul style="list-style-type: none"> → Reposition sensor cabling Shield sensor leads → Shield sensor leads → Contact your supplier

11 TECHNICAL DATA

Casing	
Material	100% recyclable ABS casing for wall mounting
Dimensions (L x W x H) in mm, weight	175 x 134 x 56; approx. 360 g
Protection class	IP20 as defined by VDE 0470
Electrical specifications	
Supply voltage	AC 230 V/50 Hz, -10...+15%
Radio interference class	N (as defined by VDE 0875)
max. line diameter 230 V connectors	2.5 mm ² fine-/single-wire
Temperature sensor	PT1000, 1 kΩ at 0 °C
Measuring range	- 30°C .. +250°C
Test voltage	4 kV 1 min (VDE 0631)
Switching voltage Current per switched output Total current for all outputs	230 V~ / 1 A / approx. 230 VA for cos φ = 0.7-1.0 4 A / approx. 900 VA maximum
Fuses	Fine-wire fuses, 5 x 20 mm, 4 A (T) (4 amps, time delay)
Other	
Recommended flow transmitter	Grundfos Sensor VFS 2-40
Operating temperature	0 ... + 50°C
Storage temperature	-10 ... + 65 °C

Specifications subject to change as technical improvements are made.

12 PT1000 RESISTANCE TABLE

Temperature sensors can be checked for proper function by using an ohmmeter and consulting the following temperature resistance table:

Temperature in °C	Resistance in ohms	Temperature in °C	Resistance in ohms
-30	882	60	1232
-20	921	70	1271
-10	960	80	1309
0	1000	90	1347
10	1039	100	1385
20	1077	120	1461
30	1116	140	1535
40	1155	200	1758
50	1194		

13 DECLARATION OF CONFORMITY

We, PROZEDA GmbH, declare under our sole responsibility that the Regtronic PC type 1317 product complies with the following standards:

DIRECTIVE 2004/108/EC OF THE EUROPEAN PARLIAMENT AND OF THE COUNCIL of 15 12.2004 on the approximation of the laws of the Member States relating to electromagnetic compatibility and repealing Directive 89/336/EEC Law on the electromagnetic compatibility of equipment (EMC) of 26 February 2008

DIRECTIVE 2006/95/EC OF THE EUROPEAN PARLIAMENT AND OF THE COUNCIL of 12 December 2006 on the approximation of the laws of the Member States concerning electrical equipment for use within certain voltage limits

DIN EN 61326-1, VDE 0843-20-1:2006-10 Electrical measurement, control and laboratory use - EMC requirements - Part 1: General requirements (IEC 61326-1:2005); German version EN 61326 -1:2006

DIN EN 61326-2-2, VDE 0843-20-2-2:2006-10 Electrical measurement, control and laboratory use - EMC requirements - Part 2-2: Particular requirements - Test, operating conditions and performance requirements for portable test, measurement and monitoring equipment for use in low voltage power supply systems (IEC 61326-2-2:2005); German version EN 61326-2-2:2006