

# Installation and Operating Instructions

## Radio frequency receiver

### INSTAT 868-a4...

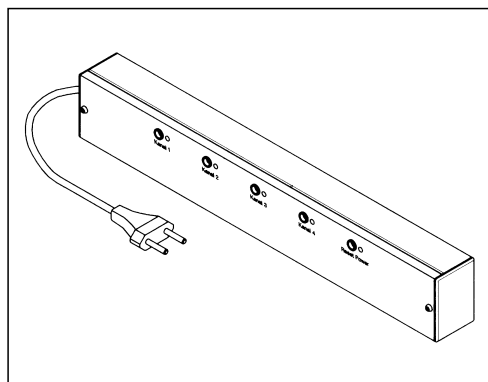

RF approval is available for the following countries: Germany, France, England, Netherlands, Belgium, Luxembourg, Norway, Denmark, Sweden, Switzerland, Finland, Spain, Italy, Austria, Ireland, Iceland, Portugal.

CE 0125 Ⓢ

## Contents:

1. Application
2. Features
3. Function description
  - 3.1 Function – Switching mode –
  - 3.2 Function – Pump logic –
  - 3.3 Function – Time switch function –
  - 3.4 Function – Master/Slave –
  - 3.5 Heating/Cooling changeover
  - 3.6 Deleting the radio link
  - 3.7 Testing the radio distance
  - 3.8 Identifying active radio links
  - 3.9 Lamp function
  - 3.10 Bridge function
4. Installation
5. Commissioning
  - 5.1 Establishing the radio link
  - 5.2 Valve test
  - 5.3 Power failure
  - 5.4 Quit/Reset
  - 5.5 Faults
  - 5.6 Troubleshooting
6. Technical data
7. Dimensions
8. Wiring diagrams and examples
9. Brief operating instructions

### Warning!

This unit must not be opened and installed except by authorized persons and in compliance with the circuit diagram provided on the pcb. It is mandatory in all work on the unit to observe the current safety regulations. In order to classify for protection class II it is necessary to take adequate installation measures. This separately mounted unit is designed for temperature control exclusively in dry and closed rooms with standard environment. The unit features radio-interference suppression in compliance with VDE0875 T.14 and EN55014, respectively and works according to operating principle 1C (EN60730).

## 1. Application

This module of the *INSTAT 868*-family converts the information from a transmitter, e.g. *INSTAT 868-r...*, into control signals for the loads.

## 2. Features

- Ready to plug-in, for immediate connection to a 230 V conduit box
- 230 V actuators can be directly connected
- 24 V actuators switchable via volt free contacts (separate transformer required)
- 4 receive channels in one housing
- or 3 receive channels and one output for pump logic, e.g. for switching off the circulating pump when all valves are closed
- or 2 receive channels, each with one associated time switch output
- Master/slave function (master dictates switching times)
- Changing Heating/Cooling mode
- Valve test function
- Radio link test and system demonstration
- One transmitter can control several receive modules
- Self-learning address setting due to "Learning mode" in the transmitter
- One push-button per output for setting functions
- One signal lamp per output to indicate relay status, faults, etc.
- One reset button
- Acoustic signal in case of faults
- Monitoring valid addresses
- Monitoring the transmitter (if no signal has been received from the transmitter for an extended period of time, for instance, when the battery is empty, the output is switched on for 30% of the time and the signal lamp flashes).

## 3. Function description

The *INSTAT 868-a4* receiver converts radio signals from a transmitter, for instance, *INSTAT 868-r*, into control signals for loads. The loads are switched by means of a relay with changeover contacts. The switching condition is indicated by the respective signal lamp.

For relay switching characteristics, see Installation instructions for the transmitter under Item "Function description".

For controlling loads, the output can be configured in different ways. The functions subsequently listed can be combined in an *INSTAT 868-a4*.

### 3.1 Function – Switching mode – "One transmitter controls one switching output"

Up to 4 transmitters control one output each (channels 1...4) for heating ON/OFF (possibly, channel 4 lights up, see Section 3.2). One or more actuators can be connected to each output. For example, see Fig. 1.

### 3.2 Function – Pump logic –

Up to 3 transmitters control one output each (channels 1...3) for heating ON/OFF. Channel 4 output serves as a common pump logic output.

The pump is switched off, **LED 4 extinguishes** (if none of the available transmitters has not called for heat (for more than approx. 10 minutes). The pump is switched by the **break contact** of the relay. This means that "emergency operation" of the heating system is possible in the event of a power failure if "normally open" actuators are used.

By parallel connection of the channel 4 outputs, the pump logic can be extended to several receiving modules. To avoid short circuits in the slave units, remove bridges BR 4, BR 5. Supply slave units via terminal 7, 8 of the master unit, see Fig. 2.

This function is always activated, as long as **channel 4 is not programmed to a transmitter**. Reactivation is possible only via Item 3.6 "Delete radio links".

### 3.3 Function – Time switch output – "One transmitter controls one switching and an associated time switch output"

(Not possible with *INSTAT 868-r1*)

One transmitter controls one output for heating "ON/OFF" and one time switch output for temperature setback. Two adjacent outputs respectively are combined to form pairs, the one with the lower number switches the actuator, the one with the higher number serves as a time switch output, see Fig. 3.

The time switch output switches "ON" if the controlled temperature  $\downarrow$  (night) is active on the transmitter and the warm-up period has not yet started.

This output can, for instance, be used to control the temperature setback input for other controllers. Outputs which are not used for temperature setback, can be freely assigned to other transmitters. The time switch function is independent of the transmitter operating mode. For 'party', 'manual operation' and 'frost protection' in the transmitter, the switching times of the weekly program apply. If the daily program is active, its respective switching times apply.

### 3.4 Function – Master/Slave –

In the case of this function, the slaves follow the master switching times.

Master/Slave is activated, if:

- Channel 1 = Master (*INSTAT 868-r*, clock thermostat)
- Channels 2...4 = Slave (*INSTAT 868-r1*)

Only slaves in the automatic mode follow the master.

Only one master is possible. It must always be assigned to channel 1. If other *INSTAT 868-r* are assigned to higher channels, these do **not** follow the master (the slaves do). In case of masters failing, the slave receive channels provide control to the comfort temperature, set on the slave controllers. For example, see Fig. 4.

## 3.5 Changing Heating/Cooling mode

With this function the *INSTAT 868-a4* can be used for heating or for cooling. The switching behaviour of all outputs will be reversed (in case activated pump logic will be maintained without reverse). The function "time switch" is not reversed.

### For cooling mode (summer time)

1. Button at channel 3 and "reset" button pressing at the same time.
2. At first release button "reset" then button "channel 3"

### For heating mode (winter time) (as delivered condition)

1. Button at channel 4 and "reset" button pressing at the same time.
2. At first release button "reset" and then button "channel 4"

## 3.6 Deleting the radio link

To delete all radio links:

1. press push-button at channel 1 and reset button simultaneously.
2. release reset button first, then channel 1 push-button. This deletes all radio links.

Any necessary links must be established new (see Item 5.1).

Now, after having pressed the reset button, none of the lamps must light up briefly see 3.8..

## 3.7 Testing the radio distance

To determine the distance of the radio link, the following procedure has to be followed:

### On the transmitter:

Set the transmitter to Learning mode

### Then on the receiver:

1. Press the channel 2 push-button and reset button simultaneously.
2. Release the reset button first, then the channel 2 push-button. Channel 2 signal lamp lights up. The signal tone and the relay operate in the switching mode., approx. 2 sec. "ON", approx. 8 sec. "OFF". Now, while holding the transmitter in your hand, walk away from the receiver until you reach the point where the signal tone can no longer be heard and the relay is about to stop operating. This is the maximum possible radio link distance.

After a certain period, the transmitter automatically ceases to operate in the "Learning mode". Always terminate the radio link test in the receiver by pressing the reset button.

Any other channels are not affected by the radio test.

## 3.8 Identifying active radio links

Having pressed the reset button, the programmed channels are indicated by the respective channel lamps briefly lighting up.

## 3.9 Lamp function

The signal lamps provide information about the respective channel:

- Heating "ON/OFF" In normal operating mode, steady light is possible
- Faults Flashing, 1 sec. interval, number varies depending on type of fault s. 5.5
- Learning mode Permanently "ON"
- Valve test "ON" until push-button is pressed
- Radio test Flashing, 10 sec. interval

## 3.10 Bridge function

BR 1: Opening for switching beeper OFF (single-pole plugging prevents loss of bridge)

BR 4, 5: Opening for double-pole insulation of the supply voltage from the switching voltage

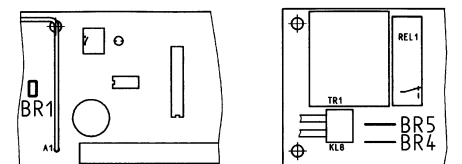

see wiring diagram

## 4. Installation

Mounting: for instance

- In the distribution board on DIN rail
- In the heating circuit distributor on DIN rail
- Mounting position: any
- The unit must not have contact with water.

### Electrical connection of operating voltage:

Insert plug into conduit box. If a direct connection is required, cut the plug off and clamp the wires.

### Connecting the actuators:

Before inserting the cables, make a hole in the nipple using a round, pointed object.

### Electrical connection:

#### (switch off mains supply)

See diagram on the printed circuit board and Item 8. In the as-supplied condition, the unit is designed for switching 230 V actuators. The actuators are simply connected to the terminals (a-c [normally-open] and b-c [normally-closed]) of the respective channels by means of both leads (terminals 7, 8 are not connected).

### For switching a second voltage of up to 230/400V max. (also for 24 V actuators):

Remove bridges BR 4 and BR 5 **completely**.

The second voltage is fed via terminals 7, 8 (between channels 2 and 3). Example, see Fig. 3.

By removing bridge BR 3, channels 3/4 can be operated with a voltage different from that of channels 1/2 (via terminals 7, 9).

### Note:

Having **removed** bridge BR 3 channels 3/4 remain connected as a single-pole connection to channels 1/2.

Volt free contacts with the required safety clearance can only be obtained after **complete** removal of bridges BR 4, 5. A suitable transformer is required for 24 V.

Mount cover in volt free condition only

## 5. Commissioning

Delete all channels before commissioning, see Section 3.6.

### 5.1 Establishing the radio link

On completion of the installation work, a link between the *INSTAT 868-r...* transmitter and the respective output (channels 1...4) must be established.

This must be carried out in the following sequence:

- a) Set the transmitter to learning mode (see Transmitter operating instructions)
- b) 1. For function – switching mode – Set the required switching output of the receiver to learning mode. To do this: Briefly press the push-button for the desired output. A signal sounds, the associated signal lamp lights up and the output switches ON briefly. When the transmitter is identified, the signal tone ceases to sound and the associated signal lamp switches off.
2. For function – pump logic – As with b1, however, a transmitter must not be assigned to channel 4.
3. For function – time switch output – Set the desired switching output of the receiver and the associated time switch output to learning mode. To do this: press both the push-button for the desired switching output (channels 1,3) and the push-button for the time switch output (channels 2,4) (e.g. press 1, 2). A signal sounds, the associated two signal lamps light up and the two outputs switch on briefly.
- c) When the transmitter is identified, the signal tone ceases to sound and the associated signal lamps extinguish.
- d) Terminate the learning mode on the transmitter
- e) Testing the established radio link, see Section 3.8.

It is not possible to assign one transmitter to several outputs in the same unit. However, one transmitter can control several outputs in different receiving modules. To establish the radio link, only one transmitter must be in the learning mode.

### 5.2 Valve test

When the push-button of an associated output is pressed:

- the associated output switches ON (as long as the push-button is pressed),
- the signal lamp lights up,
- the signal tone sounds.

After releasing the output button, the reset button must be pressed within 10 sec.

As a result of this, the signal lamp extinguishes and the signal tone ceases to sound.

After 10 sec., the learning mode starts; a link would be established to a transmitter which happens to be in the learning mode.

### 5.3 Power failure

If there is a power failure in the transmitter or in the receiver, all data will be saved. When power supply is restored, normal operation is resumed.

### 5.4 Quit/Reset

- To
- quit the learning mode or
  - acknowledge a failure or
  - terminate the radio link distance test or
  - terminate the valve test or
  - in the event of any other inexplicable phenomena

press the reset button. This switches the relays to the OFF status. When new actuating signals are received (possibly after 10-20 min.), they will continue to work. Any existing radio link will be maintained.

## 5.5 Faults

If faults occur, an alarm is triggered. In this case, the signal lamp flashes with varying duration, if necessary, a signal tone sounds.

### 5.5.1 Double addressing

In this case the signal lamp flashes permanently two times short one after the other. The signal sounds be cancelled by re-learning one of the both transmitters. The output is switched with 30% capacity (3 minutes ON, 7 minutes OFF).

### 5.5.2 Brief losses of the transmission signal

If the transmitter fails to receive an actuating signal within a period of 1 and up to ~10 hours, the signal lamp shows a permanent one brief flash. No signal tone sounds. The output is switched with 30% of the manipulated variable (3 min. ON, 7 min. OFF). Upon the transmission signal recurring, the alarm automatically ceases.

### 5.5.3 Longer losses of the transmission signal

If the transmitter has not received an actuating signal for more than 10 hours, the signal lamp shows permanent one short flash. The signal tone sounds. The output is switched with 30% of the manipulated variable (3 min. ON, 7 min. OFF). Upon the transmission signal recurring, the alarm automatically ceases.

#### Note:

- In the case of heating systems that are in stand-by mode even in the summer, e.g. electric heaters, the valve protection (in the transmitter) must be switched off. In the other case the output would be switched On for 3 minutes each day!
- The signal tone can be switched off permanently by removing bridge BR 1.

For all types of faults, the following applies:

- Function – Switching mode – A fault at one output will not affect the other outputs.
- Function – Pump logic – A pump keeps ON operating in the alarm mode (already after one transmitter has failed).
- Function – Time switch output –: The faulty behaviour also applies to the associated time switch output.
- Function – Master/Slave – In the case of the master failing, the slaves are switched to comfort mode.
- A flashing signal lamp indicates the alarm status, not the switching status of the output.
- After a power failure in the transmitter or in the receiver, normal operation is resumed.
- Under unfavourable local conditions it is possible that the radio link between the transmitter and the receiver is insufficient, for instance, if the receiver is installed in an interference-proof metal housing. Please check whether the situation improves when the transmitter is arranged in a different position. For checking the radio link, see Section 3.7. If necessary, the additional aerial can be used.

**Table 1: When the radio link does not work...**

Check the following:	Yes	No
1. Receiver: Is signal lamp 'Power' lighting up?	Continue with 2	Check power supply possibly the unit is defective
2. Receiver: Is a channel 1...4 signal lamp flashing? Can the warning tone be heard? (possibly only after one hour)	Double addressing see Section 5.5.1 or transmission signal is missing	Continue with 5
3. Press the reset button. Are the required channel signal lamps lighting up briefly? See Item 3.8	Continue with 4	Transmitter not programmed Reprogram, see Section 5.1
4. Transmitter: Is the battery OK?	Continue with 5	Insert new batteries
5. Transmitter: Adjust to 30 °C. Is the relay switched on after ~30 sec? (signal lamp lights up).	Continue with 6	Relay was already switched on Continue with 6 or transmission signal is missing, continue with 7
6. Transmitter: Adjust to 5 °C. Is the relay switched off after ~30 s (signal lamp does not light up)	<b>Everything OK</b>	Transmitter signal is missing, continue with 7
7. Transmitter-receiver-actuator: Check wiring, if necessary, reprogram connection to radio receiver.	<b>Everything OK</b>	Continue with 8, if necessary, check radio link distance, see Section 3.7
Are Items 5 and 6 now successful?		"Testing the radio link distance"
8. Reduce distance between receiver and transmitter to ~2 m (not less). Are Items 5 and 6 now successful?	Transmitter and receiver are working properly (Use additional aerial if necessary)	Transmitter or radio receiver are defective

**Note:** In individual cases it may not be possible to establish a permanent radio link between radio transmitter and radio receiver. The reason for this is not to be attributed to our radio control, but to the radio distance to be used. Therefore, we recommend checking its proper functioning at the respective place of installation.

## 7. Dimensions (for INSTAT 868-a4)

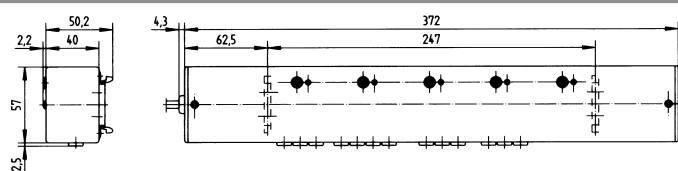

## 5.6 Troubleshooting

### 1. Valve does not open:

- Has it been properly wired up?
- Has the radio link been established? (see Section 5.1)
- See table 1 up from item 3.
- Press the reset button (see Section 5.4)!

### 2. The signal lamp for a radio channel flashes and possibly a beeper is sounding

- For basic fault procedures, see Section 5.5
- Learning mode, valve test, radio range test have not been interrupted (see Sections 5.1, 5.2, 3.7, 5.4)!
- Two transmitters are transmitting with the same address; reprogram the associated radio link (see Section 5.5.1)!
- No radio link, see Item 7 in the Table 1!
- One or more channels which are not in use are flashing. These channels have lost their transmitter. Proceed as described under Section 3.6 'Deleting the radio link'. Re-learn needed links.

### 3. The channel 4 signal lamp lights up, although no transmitter has been programmed.

- Channel 4 serves as a pump logic, see Section 3.2.

In the case of inexplicable faults it is recommended to press the reset button on the receiver and, if necessary, on the transmitter.

## 6. Technical data

Type	INSTAT 868-a4
Article-No.	0536 40 140 002
Operating voltage	230 V (195...253 V) 50/60 Hz
Power consumption	< 3 VA
Ambient temperature	0...+50 °C (without condensation)
Storage temperature	-20...+60 °C
Aerial	Internal
Additional aerial	ZA 193 771
Push-button: for programming	4
for reset	1
Lamps: for programming	4
for operating volt.	1
Load circuit:	4 changeover contacts, 8 A cos φ = 1; 2 A cos φ = 0.6** 24 ... 230 V AC volt free*
Number of actuators per contact:***	
230 V	3 W each electrothermal
24 V	10*** max. 4*** max.
Double-pole insulation voltage when bridges BR 4, 5 are opened	400 V* max.
Single-pole insulation voltage when bridge BR 3 is opened	230 V* max.
Protection class of housing	IP 40 / insulated
Weight	~530 g

\*) After complete removal of bridges BR4, 5, a creepage distance and clearance of 8 mm between the operating voltage and the relay terminals is guaranteed. The unit is therefore suitable for switching safety extra-low voltage (SELV).  
After removal of bridge BR 3, the two switching units (channels 1/2 against channels 3/4) show a 230 V basic insulation.  
\*\*) Total of all currents ≤ 10 A  
With a total of all currents of >2 A, install as described under "Switching a second voltage" (see Item 4, Installation).  
\*\*\*) A maximum of 10 x 4 = 40 (230 V) actuators or 4 x 4 = 16 (24 V) actuators respectively can be controlled by an INSTAT 868-a4 at one time. Four actuators can be mechanically connected to the six-point terminal. If there are more actuators, provide external terminal points.

## 8. Wiring diagrams and examples

**Fig. 1**

Each transmitter controls a switching output for heating ON/OFF. No master/slave. Graphical representation of 230 V actuators.

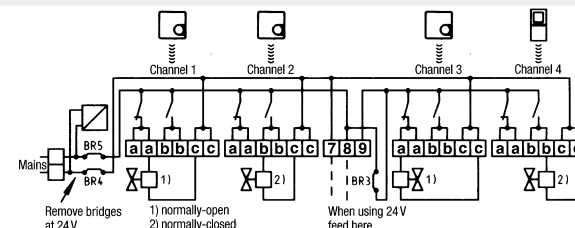

**Fig. 2**

Each transmitter controls a switching output for heating ON/ OFF. Additional pump logic. No master/slave. Graphical representation of 230V actuators/pump.

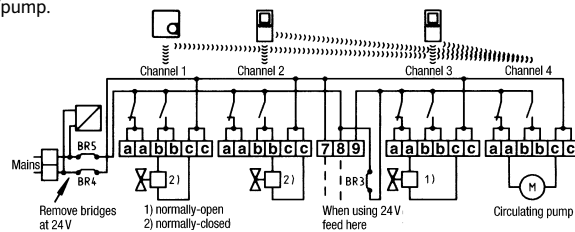

**Fig. 3**

Each master controls one switching output (channel 1) and an associated time switch output (channel 2) for temperature setback of other controllers. Slaves on channels 3, 4. Graphical representation of 24 V actuators

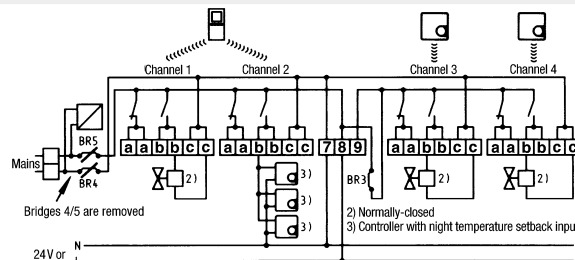

**Fig. 4**

One master (channel 1) with 2 slaves (channel 2, 3). Additional pump logic (channel 4). A third slave can be programmed at channel 4. Connect a valve instead of a pump. Graphical representation 230 V actuators

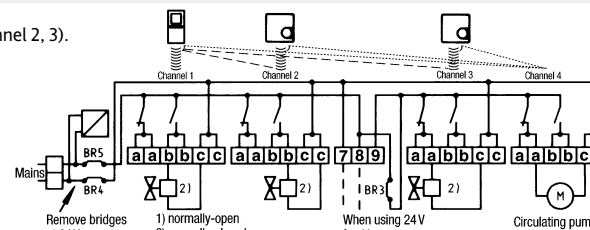

## 9. Brief operating instructions for the INSTAT 868-a4 radio frequency receiver

<b>Deleting the radio links</b>	3.6	<ul style="list-style-type: none"> <li>• Press the <b>channel 1 button + the reset button</b> simultaneously</li> <li>• Release the <b>reset button</b>, then the <b>channel 1 button</b></li> </ul>
<b>Testing the radio distance</b>	3.7	<ul style="list-style-type: none"> <li>• Set transmitter to <b>Learning mode</b></li> <li>• Press the <b>channel 2 button + reset button</b> simultaneously</li> <li>• Release the <b>reset button</b>, then the <b>channel 2 button</b></li> <li>• Channel 2 signal lamp lights up</li> <li>• Signal tone + relay are operating in the switching mode (brief ON - extended OFF)</li> <li>• When the switching mode ceases to operate, the radio distance is exceeded</li> <li>• Press the <b>reset button</b> for termination</li> <li>• Transmitter: switch off Learning mode</li> </ul>
<b>Establishing the radio link</b>	5.1 or 3.1	<ul style="list-style-type: none"> <li>• Set <b>transmitter to Learning mode</b></li> <li>• Briefly press the <b>channel button!</b></li> <li>• Signal lamp lights up + signal tone sounds</li> <li>• When transmitter is identified, signal lamp + tone will stop</li> <li>• Transmitter: switch off <b>Learning mode</b> - press the <b>OK button</b></li> </ul>
Function pump logic	3.2	<ul style="list-style-type: none"> <li>• Channels 1, 2, 3 Switching mode - Channel 4 Pump logic</li> <li>• Function is active, as long as channel 4 is not programmed</li> <li>• Like function "Switching mode"</li> </ul>
Function	3.3	<ul style="list-style-type: none"> <li>• Set Transmitter to Learning mode</li> <li>• Briefly press <b>channel 1 + 2</b> or <b>channel 3 + 4 buttons</b></li> <li>• Signal lamps light up + signal tone sounds</li> <li>• When transmitter is identified, signal lamp extinguishes and signal tone ceases to sound</li> <li>• lower number = switching output (actuator)</li> <li>• higher number = time switch output</li> <li>• Transmitter: switch off <b>Learning mode</b></li> </ul>
Switching and time switch output	3.4	<ul style="list-style-type: none"> <li>• Slaves follow master switching times</li> <li>• Assign master to channel 1, program slaves to following channels</li> </ul>
Function Master/slave	3.4	<ul style="list-style-type: none"> <li>• Slaves follow master switching times</li> <li>• Assign master to channel 1, program slaves to following channels</li> </ul>
<b>Changing Heating/Cooling mode</b>	3.5	<ul style="list-style-type: none"> <li>• Winter mode (as-delivered condition)</li> <li>• Press the <b>channel 4 + the reset button simultaneously</b></li> <li>• Release the <b>reset button</b>, then the <b>channel 4 button</b></li> <li>• Summer mode</li> <li>• Press the <b>channel 3 button + the reset button simultaneously</b></li> <li>• Release the <b>reset button</b>, then the <b>channel 3 button</b></li> </ul>
Heating		<ul style="list-style-type: none"> <li>• Press the <b>reset button</b> – programmed channels will be briefly displayed</li> </ul>
Cooling		<ul style="list-style-type: none"> <li>• Press the <b>channel button</b></li> <li>• As long as the channel button is pressed, the output switches On</li> <li>• Press the <b>reset button within 10 sec.</b> after releasing the channel button</li> </ul>
<b>Displaying programmed channels</b>	3.8	<ul style="list-style-type: none"> <li>• Press the <b>reset button</b> – programmed channels will be briefly displayed</li> </ul>
<b>Valve test</b>	5.2	<ul style="list-style-type: none"> <li>• Press the <b>channel button</b></li> <li>• As long as the channel button is pressed, the output switches On</li> <li>• Press the <b>reset button within 10 sec.</b> after releasing the channel button</li> </ul>
<b>Signal lamp - Fault messages</b>	5.5	<ul style="list-style-type: none"> <li>• Double addressing - reprogramming the transmitter</li> <li>• Brief losses of transmitter signal (1 h up to 10 h)</li> <li>• Extended losses of transmitter signal (more than 10 h)</li> <li>• Output receives 30% of the manipulated variable (3 min. ON - 7 min. OFF)</li> </ul>