



	Page
Contents	2
General information	3
Characteristic lines	4
Contents of measuring case	5
Component connection diagram	6
Technical data	8
Keyboard	9
Main menu	10
System-Setup	10
Measurement-Setup	11
Valve-Setup	11
Temperature measurement	11
Measurement	12
Balanced pressure method	12
Data Logging	12
Kv-value-method	13
Measurement of "Cocon" valves and metering stations	13
Computer-method	13
OV-Balance	14
Storage and printing of valve data	23
Example	24
Batteries	25
Display	25
Functional messages	26
Error messages	27
Address	28

Subject to modification without notice. Oventrop does not accept liability for the accuracy of the OV-DMC flow-meter readings.

General information:

The flow meter "OV-DMC 2" was specially designed for flow measurements and the hydronic balancing of heating and chilled water a/c systems. In practice, operation off the line is guaranteed by using rechargeable batteries. To facilitate handling, null balance is automated. This process of changeover to the measuring position of the measuring head is taken over by an electric motor which is automatically triggered by the flow meter during each measurement. This step largely protects the measuring head against any damage. To protect the measuring head from contamination, the inlet and outlet nipple are provided with integrated strainer inserts. Nipples for replacement are supplied with each flow-meter (see part 17) and can be replaced by using a standard spanner (spanner size 17 mm). Spare part number of the nipples for subsequent ordering: 106 91 86.

Attention:

- Before the measuring hoses are connected to the double regulating and commissioning valve, the flow meter has to be connected to the measuring head and has to be switched on.
- Provide for free water flow through measuring hoses. Clean or replace strainer inserts of the measuring hose in case of heavy pollution.

For further details regarding function sequences see page 10 and onwards.

The logical structure and the consequent query on the display offer a good condition to carry out hydronic balancing of existing installations without calculation. Presetting of a double regulating and commissioning valve can be calculated by using the balanced pressure method, computer method or OV balance method after having entered the valve size and the nominal flow rate. The presetting values of individual double regulating and commissioning valves can be calculated on the basis of the characteristic lines of all Oventrop double regulating and commissioning valves as well as those of some competitors which are stored in the flow meter (see list below).

When using the "OV-DMC 2" for the regulation of valves which are not produced by Oventrop, the corresponding kv-value has to be entered before the first measurement. To do so, the kv-value method is chosen in the menu "Measurement-Setup". Any data obtained during measurement is stored in the "OV-DMC 2" and can be processed via a PC under Windows which guarantees the filing of any data obtained during hydronic balancing. Moreover, temperature can be measured by using the flow meter. To do so, the sensor is introduced into the pressure test points at the double regulating and commissioning valve. As for the double regulating and commissioning valves "Hycocon", the temperature must be seized at the pipework or the valve body.

Characteristic lines:

Characteristic lines of the Oventrop valves:

- Double regulating and commissioning valves "Hydrocontrol R" DN 10 to DN 65
- Double regulating and commissioning valves "Hycocon V" DN 15 to DN 40
- Regulating valves "Hycocon T" DN 15 to DN 25
- Double regulating and commissioning valves "Hydrocontrol G" DN 65 to DN 300
- Double regulating and commissioning valves "Hydrocontrol F" DN 20 to DN 300
- Double regulating and commissioning valves "Hydrocontrol FR" DN 50 to DN 200
- Double regulating and commissioning valves "G-86" DN 10 to DN 65 (Swedish market)
- Double regulating and commissioning valves "RF-93" DN 20 to DN 300 (Swedish market)
- Regulating valve for chilled ceiling installations "Cocon kv 0.45" DN 15
- Regulating valve for chilled ceiling installations "Cocon kv 1.0" DN 15
- Regulating valve for chilled ceiling installations "Cocon kv 1.8" DN 15
- Bronze metering station DN 15 to DN 50
- Flanged stainless steel metering station DN 65 to DN 600
- Flanged cast iron metering station DN 65 to DN 300

Characteristic lines of other valves:

- Tour & Anderson (stored values taken from the catalogue 1999)
- Flanged valve type "STAF" DN 20 to DN 300
- Flanged valve type "STAF-SG" DN 20 to DN 300
- Flanged valve type "STAF-R" DN 65 to DN 150
- Female threaded valve type "STA" DN 15 to DN 50
- Female threaded valve type "STAD" DN 10 to DN 50
- Male threaded valve type "STADA" DN 10 to DN 50
- Female threaded valve type "STA-DR" DN 15 to DN 25

Crane (stored values taken from the catalogue 2000):

Double regulating and commissioning valves:

- Fig.-No. D 930: DN 10 to DN 50
- Fig.-No. DM 930: DN 20 to DN 300
- Fig.-No. D922/D932: DN 15

Metering stations/combinations metering stations/valves:

- Fig.-No. D901/D941/D931: DN 15 to DN 50
- Fig.-No. DN902/D942: DN 15
- Fig.-No. DN933: DN 15
- Fig.-No. D933: DN 15
- Fig.-No. D934: DN 15
- Fig.-No. DM900/DM942: DN 20 to DN 300
- Fig.-No. DM950: DN 50 to DN 300

Hattersley (stored values taken from the catalogue 2000):

Double regulating and commissioning valves:

- Fig.-No. M737: DN 50 to DN 300
- Fig.-No. M1700: DN 15 to DN 50
- Fig.-No. 1700L: DN 15
- Fig.-No. 1710: DN 15 to DN 50

Metering stations/combinations metering stations/valves:

- Fig.-No. M2733: DN 50 to DN 300
- Fig.-No. M2943G: DN 350 to DN 600
- Fig.-No. M2944G: DN 350 to DN 600
- Fig.-No. M2963G: DN 350 to DN 600
- Fig.-No. M2964G: DN 350 to DN 600
- Fig.-No. M2973G: DN 350 to DN 600
- Fig.-No. M2974G: DN 350 to DN 600
- Fig.-No. 2473LC: DN 15
- Fig.-No. 2473L: DN 15
- Fig.-No. 2473MC: DN 15
- Fig.-No. 2473M: DN 15
- Fig.-No. 2432C: DN 15
- Fig.-No. 2432: DN 15 to DN 50
- Fig.-No. 5200: DN 15 to DN 50
- Fig.-No. M7733CSDR: DN 65 to DN 200

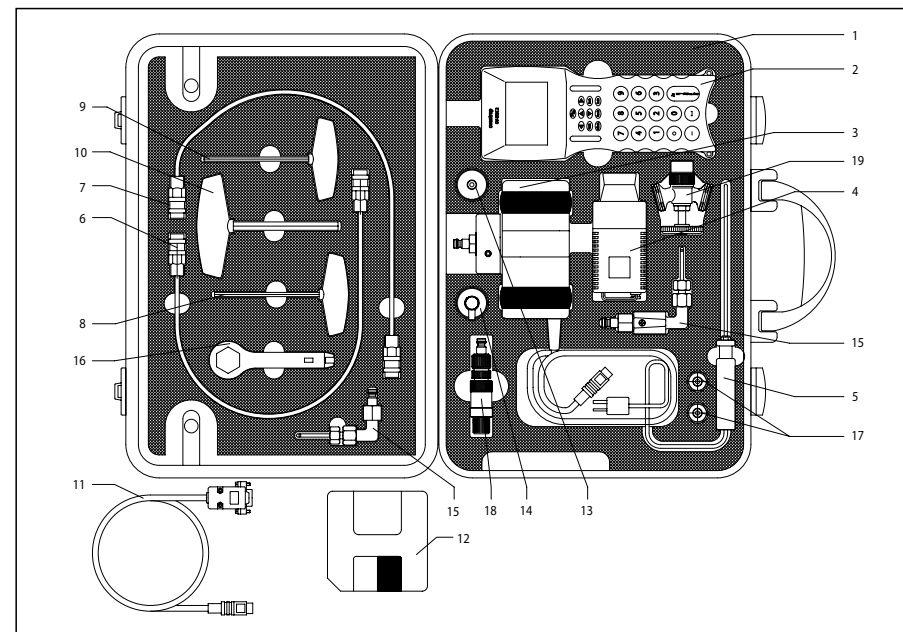

1. Measuring case
2. Flow meter "OV-DMC 2" with shoulder strap
3. Measuring head with connection cable, connection nipple for measuring hose and two rubber rings protecting the measuring head against impact
4. Power pack with connecting cable
5. Temperature sensor with connecting cable 1 m long
6. Measuring hose, red with quick couplings 0.5 m long
7. Measuring hose, blue with quick couplings 0.5 m long
8. Allen key 3 mm with black handle
9. Allen key 4 mm with black handle
10. Allen key 8 mm with black handle
11. PC connection cable to transmit stored data of the "OV-DMC 2" to the serial interface RS-232
12. Diskette for data transmission
13. 2 measuring adapters with connection thread $\frac{3}{4}$ " for quick-coupling technic Suitable for "Hydrocontrol" as well as the fill and drain tool 106 17 91 of "Hycocoon"
14. Measuring adapter with connection thread $\frac{3}{4}$ " for double regulating and commissioning valves "Hydrocontrol" with needle technic
15. Set of measuring needles 106 91 99 for measuring technic "classic" of double regulating and commissioning valves, e.g. "Hydrocontrol"
16. Operating key 106 01 85 for older double regulating and commissioning valves "Hydrocontrol"
17. Two connection nipples 106 91 86 for replacement at measuring head
18. Set of measuring needles 106 17 99 for measuring technic "eco" of double regulating and commissioning valves, e.g. "Hycocoon"
19. 2 fill and drain tools 106 17 91 for measuring technic "eco" of double regulating and commissioning valves, e.g. "Hycocoon"

Operating instructions

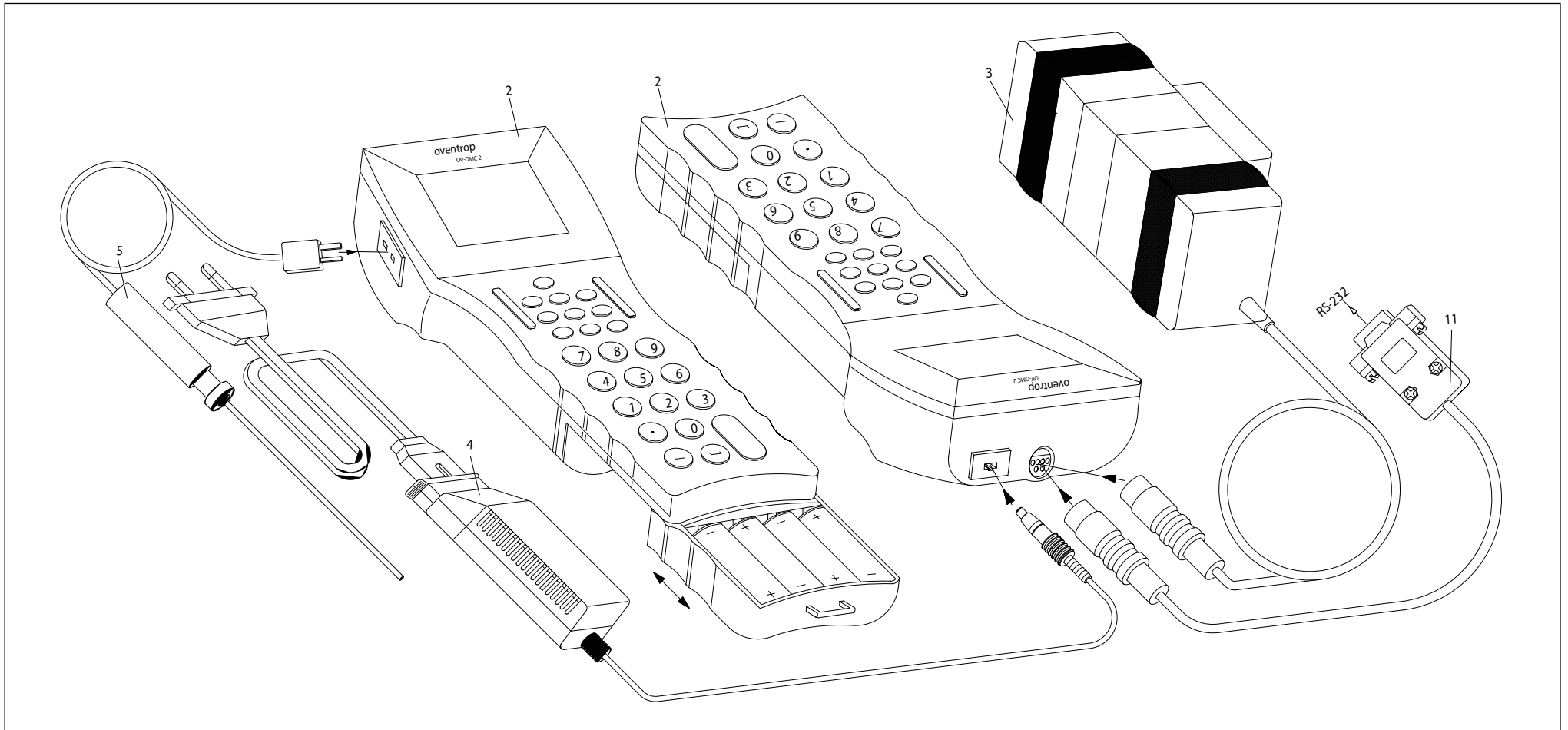

2. Flow meter "OV-DMC 2" with shoulder strap
3. Measuring head with connection cable, connection nipples for measuring hoses and two rubber rings protecting the measuring head against impact
4. Power pack with connecting cable
5. Temperature sensor with connecting cable 1.0 m long
11. PC connecting cable to transmit stored data of the "OV-DMC 2" to the serial interface RS-232

Measuring range:	Measuring range - differential pressure: -0.05 kPa to 200 kPa
	Max. static excess pressure: 2000 kPa
	Measuring range - temperature: -20°C to +120°C
Resolution:	Differential pressure: 0.01 kPa
	Flow: 0.0001 l/s
	Temperature: 0.1°C
Accuracy:	Differential pressure: up to 10 mbar ± 0.5%
	10 to 2000 mbar 1% of measured value
	Flow: 0.01 l/s
	Temperature ± 0.5°C
Ambient temperature:	Working temperature: 0°C to 40°C
	Storage: -20°C to +60°C

Attention: In case of risk of frost, no water may remain in the measuring head!

In this case, the measuring head and the measuring hoses have to be drained completely.

Humidity: Max. relative humidity of 90% non-condensing

Protection class: Body IP52
Keyboard IP54

Dimensions/weight: Flow meter: 160 x 63 x 40 mm, weight 470 g
Measuring head: 130 x 70 x 70 mm, weight 1240 g

Display: LCD display with backlighting

Power supply: 4 rechargeable NiMH batteries
or by using enclosed power pack 230 V AC 50/60 Hz
or by using 4 commercial Mignon batteries 1.5 V

Attention: In case of battery operation, the power pack must not be connected!

Interface: RS-232

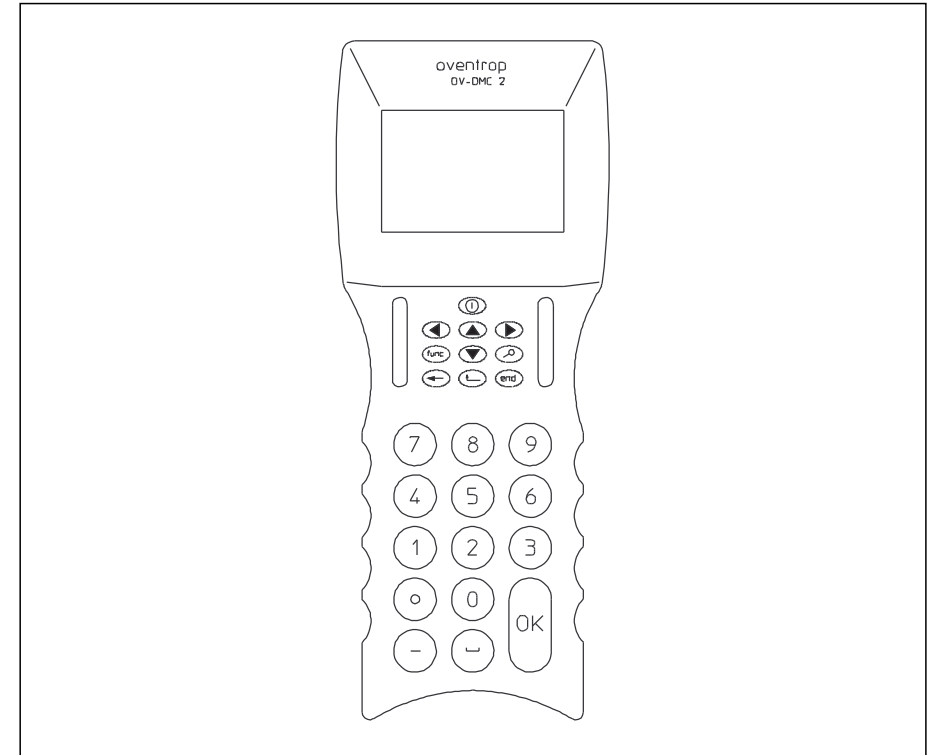

The flow meter is activated by using the key . The flow meter is switched on by pressing the key for about 1 second and is switched off by pressing it for about 3 seconds (only possible in the main menu). Before the flow meter switches off completely, some data is saved and it is checked (with the measuring head being connected) whether the bypass inside the measuring head is opened. If required, it is opened then.



Use the keys and to get from one point of the menu to the next.



Selecting key and within the menu.



Modification of flow meter setting, e.g. adjustment of the contrast of the display (see page 25).



Going back to the previous menu, e.g. from menu "Measure (start)" to menu "Valve-Setup" after having completed measurement if you perhaps want to correct a wrong entry of the valve size.



To enter the chosen submenu, press the key "OK". Depending on the chosen menu, use the keys or to get back to the overriding menu or "OK" (from menus which do not have any submenus).

Points of main menu



General information:



If the flow meter is switched on with the measuring head being connected (keep key  pressed for about 1 sec.), the main menu appears after a short initialisation.



Apart from the main menu, the symbols “—” or “I” are indicated in the right and left corner of the display.



The symbol “—” indicates that the bypass valve within the measuring head is opened.
When the symbol “I” appears, the bypass valve is closed and should under no circumstances be connected to a heating circuit! In this case, please proceed like this: A measurement with the measuring head not being connected to the heating circuit is to be carried out and to be concluded properly (so that the bypass valve is opened). The measuring head should only then be connected to the heating circuit!

System-Setup

English Choice of the language by using the keys  and . Confirm by pressing the key “OK”.

Sound The sound can be switched on or off by using the keys  and .

Light The lighting can be switched on or off by using the keys  and .

Light time The time of lighting is adjustable between 10 s and 60 s by means of the keys  and .
The lighting is reactivated by pressing any key.

Charging batteries - Charging of the batteries is activated by pressing the key “OK”.

Memory see menu “Store Measurement” (page 23).

Print content

View content

Clear memory

```



— MAINMENU —
=====
SYSTEM-SETUP
MEASUREMENT-SETUP
CHOOSE VALVE
MEASURE (START)
TEMP.MEASUREMENT
—
    
```

```



— SYSTEM-SETUP —
=====
English
sound: on
light: off
lighttime: 00 s
charge batteries
memory
—
    
```



Measurement-Setup





Measuring

method----- Choice of the measuring methods by using the keys  and .

Balanced pressure method, kv-value method, computer method, OV-Balance

Pressure----- Choice of the unit for pressure indication by using the keys  and .

Flow----- Choice of the unit for flow rates by using the keys  and .

Water----- Choice of the medium (e.g. ethylene glycol) in the heating circuit by using the keys  and .
When using ethylene glycol, indicate the percentage composition by pressing the key . The indicated value can be modified by using the keys  and .

Connect the temperature sensor to the flow meter. **An error message (see Temperature Measurement page 11) appears if there is no sensor connected.**

Change to temperature measurement by pressing the key “OK”.

Confirm the measured temperature by using the key “OK”. The main menu is called up at the same time.
Choice of the medium (e.g. ethylene glycol).

```

— MEASUREMENT-SETUP —
=====
BALANCED PRESSURE
pressure: mbar
flow: l/h
Water
—
    
```

```

— MEASUREMENT-SETUP —
=====
KV VALUE METHOD
pressure: mbar
flow: l/h
Water
—
    
```



```



— MEASUREMENT-SETUP —
=====
COMPUTER METHOD
pressure: mbar
flow: l/h
Water
—
    
```



```

— MEASUREMENT-SETUP —
=====
BALANCED PRESSURE
METHOD
pressure: mbar
flow: l/h
Ethylene glycol 35%
—
    
```

Valve-Setup

Oventrop ----- Choice of the valve manufacturer by using the keys  and .

Type----- Change to valve type by using the key .
Choice of the valve type by using the keys  and .

Size----- Change to valve size by using the key .
Choice of the valve sizes (dimensions) by using the keys  and .



```

— VALVE-SETUP —
=====
OVENTROP
type: Hydrocon
size: 020
—
    
```

Temperature measurement

Connect the temperature sensor to the flow meter.

Change to temperature measurement by using the key “OK”.

Go to main menu by pressing the keys “OK”,  or  after having measured the temperature.

An error message will appear on the display if there is no sensor connected.

Change to main menu by pressing the key “OK”, connect temperature sensor and repeat measurement.

```

— TEMP.MEASUREMENT —
=====

Temp.: 022.2 °C
Temp.: 072.0 °F
—
    
```

Measurement

Some measurements are started directly from the menu "Valve-Setup" ("Cocon" valves and metering stations). The sequence of measurement is similar to the kv-value method and is also described under that point.

For all other regulating valves, the menu "Measurement-Setup", offers different measuring methods:

Balanced pressure method/Data logging
Kv-value method Computer method OV-Balance

Balanced pressure method: The valve manufacturer as well as the valve chosen in the submenu "Valve-Setup" is indicated. "Presetting" requires the presetting of the valve to be measured. Input is completed by pressing the key "OK". Now the measuring head is activated by the flow meter and the bypass is closed automatically. The closing procedure is indicated by the rotating symbols in the left and right display corners. The closing procedure being completed (indicated by symbol "I"), it still takes a short moment before the pressure measured as well as the resulting flow rate is indicated.

Now the desired flow rate has to be entered. After having entered this value, which is confirmed by pressing the key "OK", the flow meter calculates the new presetting which it indicates as "presetting new". Now the valve has to be preset according to the new value. By pressing the key "OK" the menu "Check Measurement" is reached. Here, the new presetting value, the resulting differential pressure and the old and new flow rate (in comparison) are indicated. After having completed control, the beginning of the menu can be reached by pressing the key  and a new measurement can be carried out.

Attention: Each measurement with subsequent change of valve type has to be completed by pressing the key  !

Data Logging: Here, several measurements are carried out at different intervals and are stored in the memory of the flow meter as consecutive valve numbers.

The data logging function is started with the balanced pressure method. The command "Store" is chosen in the menu "Store Measurement" and the menu "Store Measurement" is reached by pressing the key "OK". Apart from "name", "group" and "number", the valve type, valve size, presetting, differential pressure and the flow rate are stored. This data can be printed via the serial interface.

"Store" is reached after having confirmed entry by using the key "OK". Now choose "Data Logging" by using the key  and confirm by pressing the key "OK". The menu window of "Data Logging" is reached next.

Now the clock time in minutes and the number of measurements can be entered. A maximum of 200 measurements is possible with the free storage locations being indicated in the display under "Measurements". Input has to be confirmed by using the key "OK". Data logging starts with "Start" and is confirmed by using the key "OK".

After having processed all measurements, the programme "Data Logging" is completed automatically.

To conserve the batteries, long term measurements may only be carried out with the power pack being connected. Should no power supply be available, a limited number of measurements may be carried out without the power pack. During entry the following has to be observed:

- The product of clock time and measurements may not exceed 60 (e.g. 10 measurements every 6 minutes).
- The number of measurements may not exceed 20.
- The measurement cycle may not exceed 2 hours.

If the a.m. instructions are not followed, the error message "No powerpack" appears.

Now a power pack has to be connected and the error message has to be neutralised by pressing the key "OK". The green control lamp of the flow meter lights up during power pack operation.

```

- BALANCED PRESSURE -
=====
Hydrocon R DN 020
  presetting:
             mbar
             l/h
             l/h
- presetting new: -
    
```

```

- CHECK MEASUREMENT -
=====
Hydrocon R DN 025
  presetting:
             mbar
             l/h
             l/h
- >STORE< -
    
```

```

- STORE MEASUREMENT -
=====
name: DataLog1
group: 2
number: 1
  > STORE <
- > DATA LOGGING < -
    
```

```

- DATA LOGGING -
=====
rate: 10 min
measurements: 200
next in: 10 min
  > START <
    
```

```

- DATA LOGGING -
=====
!! Error !!
No Power pack!
  > Yes <
    
```

Kv-value method: The kv-value of the valve to be measured is entered. Input is completed by pressing the key "OK". Now the measuring head is activated by the flow meter and the bypass is closed automatically. The closing procedure is indicated by the rotating symbols in the left and right display corners. The closing procedure being completed (indicated by symbol "I"), it still takes a short moment before the pressure measured as well as the resulting flow rate is indicated. The menu "Store measurement" is reached by pressing the key "OK". Apart from "name", "group" and "number", differential pressure and flow rate are stored. This data can be printed via the serial interface.

Attention: Each measurement with subsequent change of valve type has to be completed by pressing the key  !

Measurement of "Cocon" valves and metering stations: Here, the "Cocon" valve or the metering station are chosen in the menu "Valve-Setup". Choice is confirmed by pressing the key "OK" and measurement is started automatically. Now the measuring head is activated by the flow meter and the bypass is closed automatically. This closing procedure is indicated by the rotating symbols in the left and right display corners. The closing procedure being completed (indicated by symbol "I"), it still takes a short moment before the differential pressure measured as well as the resulting flow rate is indicated. By pressing the key , the measuring procedure is completed and the menu "Store measurement" is reached by pressing the key "OK". Apart from "name", "group" and "number", differential pressure and flow rate are stored. This data can be printed via the serial interface.

Attention: Each measurement with subsequent change of valve type has to be completed by pressing the key  !

Computer method: The valve manufacturer as well as the valve chosen in the submenu "Valve-Setup" is indicated. At the prompt "Preset'g 1" enter the presetting of the valve to be measured. Input is completed by pressing the key "OK". Now the measuring head is activated by the flow meter and the bypass is closed automatically. The closing procedure is indicated by the rotating symbols in the left and right display corners. The closing procedure being completed (indicated by the symbol "I"), it still takes a short moment before the flow rate measured is indicated.

Now the valve has to be preset to the new presetting which is entered at the prompt "Preset'g 2". By pressing the key "OK", the second flow value is indicated on the display. The desired flow rate has to be entered now. Input is completed by pressing the key "OK". The flow meter now calculates the new value of presetting which is indicated as "Preset'g new". Now the valve is preset according to the new value. By pressing the key "OK", the menu "Check Measurement" is reached. Here, the new presetting value, the resulting differential pressure and the old and new flow rate (in comparison) are indicated. After having completed control, the beginning of the menu can be reached by pressing the key  and a new measurement can be carried out.

Attention: Each measurement with subsequent change of valve type has to be completed by pressing the key  !

```

- KV-VALUE METHOD -
=====
Kv-val.:
             mbar
             l/h
- >STORE< -
    
```

```

- STORE MEASUREMENT -
=====
name:
group:
number:
- >STORE< -
    
```

```

- AKTIV -
=====
COCONkv045 DN 015
             mbar
             l/h
- >STORE< -
    
```

```

- STORE MEASUREMENT -
=====
name:
group:
number:
- >STORE< -
    
```

```

- COMPUTER-METHOD -
=====
Hydrocon R DN 020
  preset'g 1:
  preset'g 2:
             l/h
             l/h
- preset'g new: -
    
```

```

- CHECK MESAUREMENT -
=====
Hydrocon R DN 025
  presetting:
             mbar
             l/h
             l/h
- >STORE< -
    
```

OV-Balance: This regulation method is an advancement of the compensation method. The advantage of the OV-Balance is that the complete supply system may be balanced by only one person. The time required for the hydronic balance is reduced considerably provided that the installation is structured clearly and a consecutive numbering of all regulating valves is summarised in regulating groups. **Once the numbering has been determined, it must be kept to during measurements.** Nevertheless, individual valves may be added, deleted or moved subsequently within the group, provided they were taken into consideration during the preceding numbering of all valves.

Example of an installation with numbering of the valves:

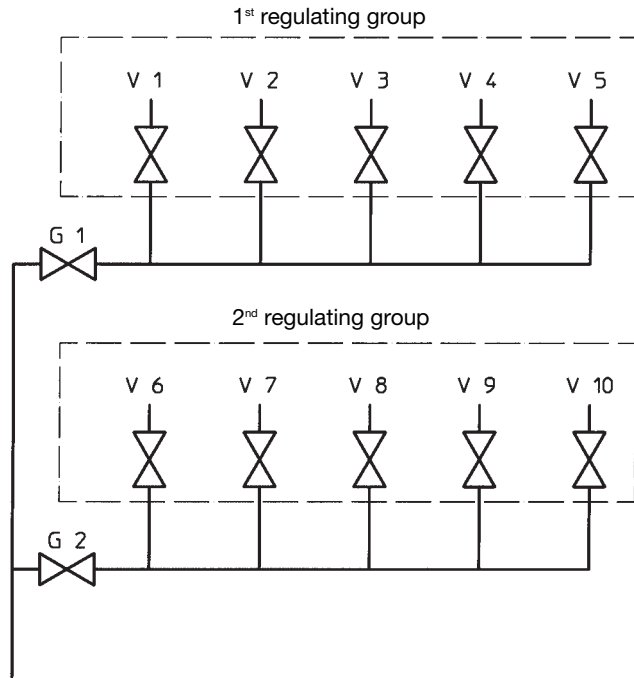

A supply system may be composed of several regulating groups. Each group has to be regulated according to the following sequence of regulation shown on page 15. The group being installed at the most remote location of the circulation pump has to be regulated first. To guarantee a sufficient differential pressure in the last group, the group valves preceding should be set to smaller presetting values. After having calculated the presetting values by using the flow meter, the valves of the regulating group are to be set. The presetting values are stored in the flow meter and can be visualised on the display by entering the name of the group. To do this, the measured values of OV-Balance can be listed in a print-out.

Before carrying out the on site regulation, it has to be verified whether all shut-off valves within the circuit are opened. Moreover it must be ensured that the installation corresponds to the design condition, e.g. thermostatic radiator valves preset, thermostatic head removed.

Sequence of regulation:

1. Number the valves of the regulating group all the way through without forgetting or skipping a valve (see example of an installation on page 14).
2. Set all valves in the regulating group to position "half opened".
The group valve may also be fully opened!
3. Measure each valve of the group to be regulated in position "half opened" and "closed" by using the flow meter. Here, the instructions of the flow meter for the sequence of measurement have to be observed! When entering the measured data of the individual valves of a group, the sequence of the measurements may be chosen freely but once the numbering of the valves has been determined, it has to be observed.
4. Measurement of the group valve of the last regulated group in position "closed".
5. Calculation of presetting values for the valves of the regulating group without group valve by using the flow meter. Operating errors and insufficient differential pressures making a calculation of the presetting values impossible, are indicated by the flow meter.
6. Set the valves of the regulating group according to the presetting values calculated by the flow meter. Should further regulating groups exist, proceed according to the steps mentioned above.
7. Regulation of the last group valve behind the circulation pump by using the computer method. Here, the total flow rate required for the preceding regulating groups is entered into the flow meter and the required presetting for the group valve is calculated. The hydronic balance of the complete supply system is only completed after having set this presetting value at the last group valve.

OV-Balance offers the following menu points:

- "Measurement"
Input of the measured data of the individual valves of a regulating group including the group valve with subsequent calculation of the required presetting values. See sequence of programme on pages 16, 17 and 18.
- "New valve"
Subsequent addition of valves to a regulating group which were not taken into consideration in the numbering before. See sequence of programme on pages 19 and 20.
- "Delete valve"
Subsequent deletion of valves of a regulating group. See sequence of programme on page 21.
- "Move valve"
Subsequent moving of valves of a regulating group if the numbering within the menu "Measurement" was mixed up. See sequence of programme on page 22.

Enter name of the regulating group (e.g. cellar)
Choose first letter by using the key **▲** and jump to the second letter by pressing the key **▶** and so on.
Go to the next menu window by using the key "OK".

```

- OV-BALANCE -
-----
NAME/GROUP NEW
name:      cellar
group:     0
          0 valves
- - - - -
    
```

Enter number of the regulating group (e.g. 1)
Go to next menu window by using the key "OK".

```

- OV-BALANCE -
-----
NAME/GROUP NEW
name:      Cellar
group;     1
          0 valves
- - - - -
    
```

User information.

Go to next menu window by using the key "OK".

```

- OV-BALANCE -
-----
*****
* number of valves *
* WITHOUT group val. *
*          Enter          *
*****
    
```

Enter the number of the regulating valves of one group (e.g. 5, without group valve)
Go to next menu window by using the key "OK".

```

- OV-BALANCE -
-----
NAME/GROUP NEW
name:      Cellar
group      1
          5 valves
- - - - -
    
```

Choose the menu option by pressing the keys **▲** and **▼** (e.g. measurement).
Go to next menu window by using the key "OK".

```

- OV-BALANCE -
-----
measure
add valve
delete valve
move
- - - - -
    
```

Enter presetting of the first valve of the group (e.g. 3.0, medium presetting.)
Go to next menu window by using the key "OK".

```

- OV-BALANCE -
----- in object -----
Cellar G.: 1 / 1
----- DN 0
3.0 preset'g. 0.0
          mbar
          l/h
- - - - - >STORE< - - - - -
    
```

Choose the valve manufacturer by using the keys **◀** **▶**.
Change to valve type via **▲** **▼**.
Choice of valve type via **◀** **▶**.
Change to valve size via **▲** **▼**.
Choice of valve size via **◀** **▶**.
Go to next menu window by using the key "OK".

```

- VALVE-SETUP -
-----
OVENTROP
type:     Hydrocon R
size:     DN 20
- - - - -
    
```

Confirm the presetting entered before by using the key "OK" while changing to the next menu window automatically.

```

- OV-BALANCE -
----- in object -----
Cellar G.: 1 / 1
Hydrocon R DN 20
3.0 preset'g. 0.0
          mbar
          l/h
- - - - - >STORE< - - - - -
    
```

User information.

Go to next menu window by using the key "OK".

```

- OV-BALANCE -
----- in object -----
!! Attention !!
adjust valve!
- - - - -
    
```

User information.

Go to next menu window by using the key "OK".

```

- OV-BALANCE -
----- in object -----
!! Attention !!
close valve!
- - - - -
    
```

Display of the presetting 0.0 for closed valve. Go to next menu window by using the key "OK".

```

- OV-BALANCE -
----- in object -----
Cellar G.: 1 / 1
Hydrocon R DN 20
3.0 preset'g. 0.0
          mbar
          l/h
- - - - - >STORE< - - - - -
    
```

User information.

Go to next menu window by using the key "OK".

```

- OV-BALANCE -
----- in object -----
!! Attention !!
enter flow!
- - - - -
    
```

Enter nominal flow rate for valve no. 1 (e.g. 500 l/h).
Go to next menu window by using the key "OK".

```

- OV-BALANCE -
----- in object -----
Cellar G.: 1 / 1
Hydrocon R DN 20
3.0 preset'g 0.0
          mbar
          500 l/h
- - - - - >STORE< - - - - -
    
```

The command for storing appears.
Go to next menu window by using the key "OK".

```

- OV-BALANCE -
----- in object -----
Cellar G.: 1 / 1
Hydrocon R DN 20
3.0 preset'g. 0.0
          mbar
          500 l/h
- - - - - >STORE< - - - - -
    
```

User information.

Set back valve to previous presetting (e.g. 3.0).
Go to next menu window by using the key "OK".

```

- OV-BALANCE -
----- in object -----
!! Attention !!
3.0
reset valve
- - - - -
    
```

Display of the next valve (2) which can be measured in the regulating group. Other valves may also be chosen by means of the keys **◀** and **▶**.
The numbering of valves once determined must be observed.
Go to next menu window by using the key "OK".

```

- OV-BALANCE -
----- in object -----
Cellar G.: 1 / 2
----- DN 00
3.0 preset'g. 0.0
          mbar
          l/h
- - - - - >STORE< - - - - -
    
```

After having completed the measurement of all valves of a regulating group, the group valve is measured. Display shows "0". Go to next menu window by using the key "OK".

```

OV-BALANCE
----- in object -----
Cellar G.: 1 / 0
Hydrocon R DN 25
3.0 preset'g. 0.0
mbar
l/h
-----
>STORE<
    
```

Choose the valve manufacturer by using the keys (left) (right). Change to valve type via (up) (down). Choice of valve type via (left) (right). Change to valve size via (up) (down). Choice of valve size via (left) (right). Go to next menu window by using the key "OK".

```

VALVE-SETUP
-----
OVENTROP
type: Hydrocon R
size: DN 25
-----
    
```

User information.

Go to next menu window by using the key "OK".

```

OV-BALANCE
----- in object -----
!! Attention !!
GROUP VALVE
-----
    
```

User information.

Go to next menu window by using the key "OK".

```

OV-BALANCE
----- in object -----
!! Attention !!
close valve
-----
    
```

Display of presetting 0.0 for closed valve. Go to next menu window by using the key "OK".

```

OV-BALANCE
----- in object -----
Cellar G.: 1 / 0
Hydrocon R DN 25
--- preset'g. 0.0
mbar
l/h
-----
>STORE<
    
```

Display of command "Store". Go to next menu window by using the key "OK".

```

OV-BALANCE
----- in object -----
Cellar G.: 1 / 0
Hydrocon R DN 25
--- preset'g. 0.0
mbar
l/h
-----
>STORE<
    
```

User information.

Set back valve to former presetting (e.g. 3.0). Go to next menu window by using the key "OK".

```

OV-BALANCE
----- in object -----
!! Attention !!
reset valve
-----
    
```

Referring to the following calculation of the presetting values. Go to next menu window by using the key "OK".

```

OV-BALANCE
-----
*****
OV-BALANCE
* ? CALCULATE ? *
* YES *
*****
    
```

Referring to incorrect calculation of the presetting values (valve no. 2 probably has to be measured again). Go to next menu window by using the key "OK".

```

!! Attention !!
check valve
--- 2 ---
    
```

After successful calculation, the presetting values can be queried according to the valve numbers (e.g. valve data of valve 1). Choice of the valve number by using the keys (left) (right). Change to main menu by pressing the key (enter).

```

SETTINGS
-----
Name: Cellar
G.: 1 No.: 1
0.20 l/h
128.0 mbar
Hydrocon R DN 20
presetting: 1.5
    
```

Menu option

```

MAINMENU
-----
SYSTEM-SETUP
MEASUREMENT-SETUP
VALVE SETUP
MEASURE (START)
TEMP. MEASUREMENT
    
```

Choose the name of the regulating group (e.g. cellar). Go to next menu window by using the key "OK".

```

OV-BALANCE
-----
CHOOSE GROUP
name: Cellar
group: 1
4 valves
-----
> N E W <
    
```

Choose the number of the regulating group (e.g. 1). Go to next menu window by using the key "OK".

```

OV-BALANCE
-----
CHOOSE GROUP
name: Cellar
group: 1
valves
-----
> N E W <
    
```

Choose calculation "No" by using the keys (left) (right). Go to next menu window by using the key "OK".

```

OV-BALANCE
-----
*****
OV-BALANCE
* ? CALCULATE ? *
* NO *
*****
    
```

Choice of the menu options by using the keys (up) (down) (e.g. new valve). Go to next menu window by using the key "OK".

```

OV-BALANCE
-----
measure
new valve
delete valve
move valve
    
```

Enter valve number of the regulating group to be added (e.g. 3). Go to next menu window by using the key "OK".

```

OV-BALANCE
-----
New Valve
name: Cellar
group: 1
no. valve: 4
add valve no.: 3
    
```

Selection of the measurement menu for the valve to be added. Go to next menu window by using the key "OK".

```

OV-BALANCE
----- in object -----
Cellar G.: 1 / 3
DN 0
3.0 preset'g. 0.0
mbar
l/h
-----
>STORE<
    
```

Change to next menu window by pressing the key (enter).

```

OV-BALANCE
----- in object -----
Cellar G.: 1 / 3
DN 0
3.0 preset'g. 0.0
mbar
l/h
-----
>STORE<
    
```

Choose the valve manufacturer by using the keys (left) (right). Change to valve type via (up) (down). Choice of valve type via (left) (right). Change to valve size via (up) (down). Choice of valve size via (left) (right). Go to next menu window by using the key "OK".

```

VALVE-SETUP
-----
OVENTROP
type: Hydrocon R
size: DN 20
-----
    
```

Enter presetting of the valve to be added (e.g. 3.0, medium presetting). Go to next menu window by using the key "OK".

```

OV-BALANCE
----- in object -----
Cellar G.: 1 / 3
Hydrocon R DN 20
3.0 preset'g 0.0
mbar
l/h
-----
>STORE<
    
```

User information.

Go to next menu window by using the key "OK".

```

OV-BALANCE
----- in object -----
!! Attention !!
adjust valve
-----
    
```

User information.

Go to next menu window by using the key "OK".

```

OV-BALANCE
----- in object -----
!! Attention !!
close valve
-----
    
```

Display of presetting 0.0 for closed valve. Go to next menu window by using the key "OK".

```

OV-BALANCE
----- in object -----
Cellar G.: 1 / 3
Hydrocon R DN 20
3.0 preset'g 0.0
mbar
l/h
-----
>STORE<
    
```

User information.

Go to next menu window by using the key "OK".

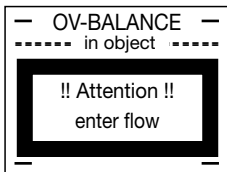

Enter nominal flow rate for valve no. 3 (e.g. 500 l/h). Go to next menu window by using the key "OK".

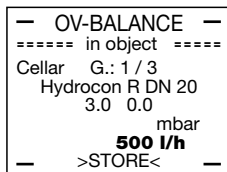

Display of command "Store". Go to next menu window by using the key "OK".

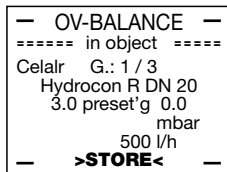

User information.

Set valve back to former presetting (e.g. 3.0). Go to next menu window by using the key "OK".

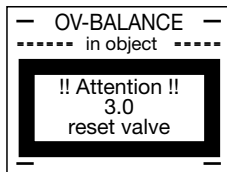

Display of next valve (2) which may be measured in the regulating group. Other valves may, however, be chosen by using the keys ◀ ▶. The numbering of valves once determined must be observed! Go to next menu window by using the key (end).

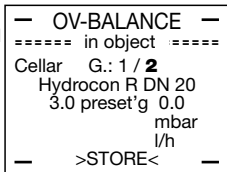

Choose calculation "Yes" by using the keys ◀ and ▶. Go to next menu window by using the key "OK".

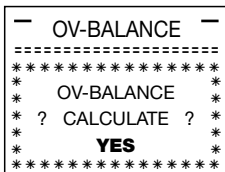

Choose "System-Setup" in main menu by using the keys ▲ and ▼.

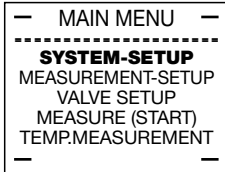

Choose "Store" by using the keys ▲ and ▼.

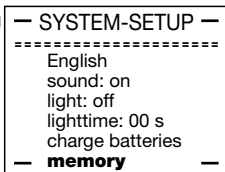

Choose "View content" by using the keys ▲ and ▼.

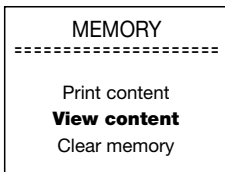

After successful calculation, the presetting values can be queried according to the valve numbers (e.g. valve data of valve 1). Choose the valve number by using the keys ◀ ▶. Change to main menu by pressing the key (end).

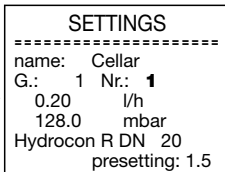

Choice of next menu option.

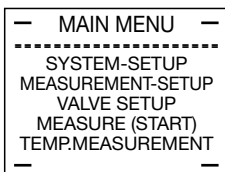

Choose name of the regulating group (e.g. cellar). Go to next menu window by using the key "OK".

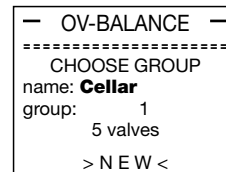

Choose number of the regulating group (e.g. 1). Go to next menu window by using the key "OK".

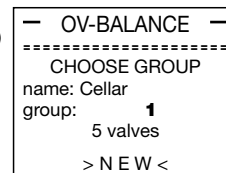

Choose calculation "No" by using the keys ◀ and ▶. Go to next menu window by using the key "OK".

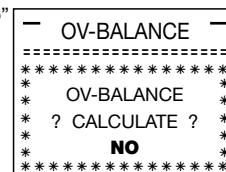

Choose menu option by pressing the keys ▲ and ▼ (e.g. delete valve). Go to next menu window by using the key "OK".

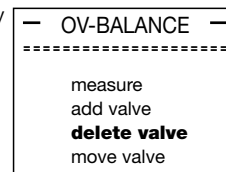

Choose valve number by using the keys ▲ and ▼.

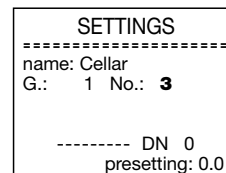

Choose the valve number of the regulating group to be deleted by using the keys ◀ and ▶ (e.g. 3). Listing of all data of the valve no. 3 to be deleted. Go to next menu window by using the key (end).

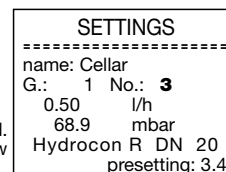

Delete valve by pressing the keys ◀ and ▶. Go to next menu window by using the key "OK".

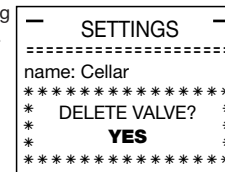

Referring to the following calculation of the presetting values. Go to next menu window by using the key "OK".

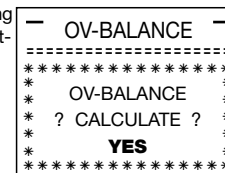

After successful calculation, the presetting values can be queried according to the valve numbers (e.g. valve data of valve 1). Choice of the valve data by using the keys ◀ ▶. Change to main menu by pressing the key (end).

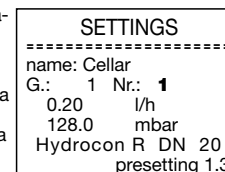

Menu option.

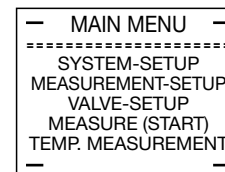

Choose name of the regulating group (e.g. cellar).
Go to next menu window by using the key "OK".

```

OV-BALANCE
-----
CHOOSE GROUP
name: Cellar
group: 1
      5 valves
      > N E W <
    
```

Choose number of the regulating group (e.g. 1).
Go to next menu window by using the key "OK".

```

OV-BALANCE
-----
CHOOSE GROUP
name: Cellar
group: 1
      5 valves
      > N E W <
    
```

Choose calculation "No" by pressing the keys **←** and **→**.
Go to next menu window by using the key "OK".

```

OV-BALANCE
-----
*****
* OV-BALANCE *
* ? CALCULATE ? *
* NO *
*****
    
```

Choose menu point by pressing the keys **▲** and **▼** (e.g. move valve).
Go to next menu window by using the key "OK".

```

OV-BALANCE
-----
measure
add valve
delete valve
move valve
    
```

Choose the valve number of the regulating group to be moved (e.g. 3) by using the keys **←** and **→**.
Listing of all data of the valve no. 3 to be moved.
Go to next menu window by using the key "OK".

```

OV-BALANCE
=== move valve ===
name: Cellar
G.: 1 Nr.: 3
Hydrocon R DN 20
      move valve no. 3
      behind valve no. 4
    
```

Referring to the following calculation of the presetting values.
Go to next menu window by using the key "OK".

```

OV-BALANCE
-----
*****
* OV-BALANCE *
* ? CALCULATE ? *
* YES *
*****
    
```

After successful calculation, the presetting values can be queried according to the valve numbers (e.g. valve data of valve 1).
Choice of the valve data by using the keys **←** **→**.

```

SETTINGS
-----
name: Cellar
G.: 1 Nr.: 1
      0.20 l/h
      128.0 mbar
Hydrocon R DN 20
      presetting: 1.3
    
```

Change to main menu by pressing the key **END**.

Menu option.

```

MAIN MENU
-----
SYSTEM-SETUP
MEASUREMENT-SETUP
VALVE-SETUP
MEASURE (START)
TEMP. MEASUREMENT
    
```

Storage of valve data

The menu "Store Measurement" offers the possibility to store measurements. Apart from "name", "group" and "number", the valve type, valve size, presetting, differential pressure and flow rate are stored. This data can be printed via the serial interface.

Name

The menu point "name" allows the entry of up to 8 alphanumeric signs (0-9, A-Z, a-z). Figures are entered by pressing the corresponding keys on the keyboard. Letters are produced by using the keys **▲** or **▼**. Each key stroke moves you either upwards (A, a, B, b...) or downwards (Z, z, Y, y...) in the alphabet.

Having reached the required letter, the cursor is moved one position to the right by using the key **→**. Then press the key "OK" to conclude entry and to jump to point "group".

A measurement to be stored, can also be stored under an existing name. To do this, you have to specify a different group- or valve number.

Group

Numerical values up to 999 can be entered here.

Press key "OK" to conclude entry.

Number

Numerical values up to 999 can be entered here.

Press key "OK" to conclude entry.

Printing of valve data

This point of the menu permits the output of the measured values via a PC. To do so, the measurements carried out must have been stored in the flow meter by using the command "Store". Up to 99 measurements may be stored and transmitted to the PC subsequently.

In order to do this, the serial transmission cable has to be connected to the flow meter and the serial interface (COM1 or COM2). The serial interface used has to be set to the following values in the system control of Windows.

Baud rate: 19200

Data bits: 8

Parity: none

Stop bits: 1

Print-out: none

After having selected "Receiving data" on the PC, the programme is waiting for the data of the "OV-DMC 2". To do this, choose the submenu "Print content" within the menu "System-Setup" and start data transfer by pressing the key "OK" on the flow meter.

```

TEMP. MEASUREMENT
-----
!! Error !!
No temperature sensor!
      > Yes <
    
```

```

CHECK MEASUREMENT
-----
Hydrocon R DN 025

presetting:
              mbar
              l/h
      > STORE <
    
```

```

STORE MEASUREMENT
-----
name:
group:
number:
      > STORE <
    
```

```

MEMORY
-----

Print content
View content
Clear memory
    
```

Example of the listing of all stored measured values

Printing the memory content shows the sequence of measurement!

Print-out of measured data (example)

Date: 30.03.00
 Project number: 47/2000
 Project: Multiple dwelling unit
 Address of project: Neubaustrasse 7, 59939 Olsberg
 Builder-owner: Herbert Häusle, Marktplatz 3, 59939 Olsberg
 Specifying engineer: Rudi Rechner
 Plumber: August Röhrich

***** Listing of all stored measured values *****

Name	Group no.	Valve no.	Valve	DN	Pre-setting	Nominal flow [m³/h]	Actual. flow [m³/h]	Diff.pressure [mbar]
Cellar	1	1	Hydrocon	15	1.36	0.15	0.15	78.03
Cellar	1	2	Hydrocon	15	2.63	0.30	0.31	78.45
Cellar	1	3	Hydrocon	20	3.60	0.60	0.61	78.32
Cellar	1	4	Hydrocon	25	1.90	0.70	0.69	77.91

View content

It is possible to view the measured values (access by pressing the key "OK"). The measurements which are stored can be viewed by using the keys and .

When moving to "group" or "number" by using the keys and , the desired measurement can be selected by using the keys and . The menu option can be exited by pressing the key .

Clear memory

It is possible to delete the stored measuring data. The display shows the message "Measurement store ?Delete? No". "No" can be changed to "Yes" by using the keys and . The command to delete the whole memory content has to be confirmed by pressing the key "OK". Before deleting, it is recommended to have the memory content printed via the serial interface. After having deleted the memory content, new measurements can be stored.

If all storage locations are occupied, it is not possible to store any more measurements and the sequence shown on the right appears (procedure as described above).

```

MEMORY
=====
Print content
View content
Clear memory
    
```

```

MEMORY
=====
Print content
View content
Clear memory
    
```

```

-- STORE MEASUREMENT --
=====
*****
* MEASUREMENT STORE *
* ? DELETE? *
* No *
*****
    
```

```

-- STORE MEASUREMENT --
=====
*****
* MEASUREMENT STORE *
* ? DELETE? *
* Yes *
*****
    
```

Batteries

1.2 V NiCd or NiMH batteries should preferably be used. The batteries should have a minimum capacity of 700 mAh but NiMH batteries with 1500 mAh are even better. The larger the capacity, the longer the battery life. Should the batteries be empty, operation can be continued by using the power pack supplied with the flow meter. Here, the green control lamp at the flow meter will light up.

The charging operation of the batteries is indicated at the flow meter by a red control lamp and can be selected in the menu "System-Setup/charge batteries".

State of charging

During the charging operation, the battery voltage and the time of charging are indicated. If the maximum charging time of 12 hours is exceeded or the charging voltage of 5.8 V is reached, the charging operation is automatically completed.

The charging operation can be interrupted by pressing the keys "OK", or .

Batteries are changed by sliding out the battery case on the lower side of the computer (see pages 6/7). When changing batteries, battery polarity + and - has to be observed.

Disposal of used batteries should be carried out by commercial waste disposal departments.

Display

Adjustment of the contrast of the LCD display.

Switch on flow meter by pressing the key .

When the name "Oventrop" appears on the display, keep the key pressed until "please wait" appears. Then "enter access code" appears.

The access code, 1234, has to be entered by using the keys. The figures 1234 do not appear on the display, only "----".

This is followed by a diagnostic menu with the contrast being adjusted by using the keys and and being completed by pressing the key .

```

-- SYSTEM-SETUP --
=====
English
sound: on
light: off
lighttime: 00 s
charge batteries
memory
    
```

```

CHARGE-MENU
=====
cell voltage: 5.3 V

time: 00h 00min
    
```

```

oventrop
    
```

```

Enter access code

---> : XXXX
    
```

```

Diagnostic-> [1]

LCD contr. down -> [<]
LCD contr. up -> [>]

End by pressing
key "end"
    
```

In the main menu "Measure (start)", the functional sequence of the measuring head is shown on the display. This message only appears on the screen for a few seconds. The sequence is continued automatically.

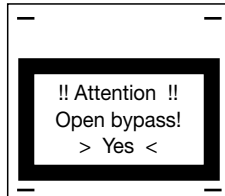
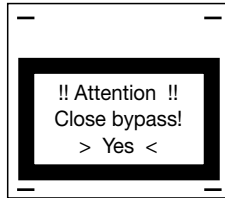

This message has no significance for the handling of the flow meter but only shows that stored data has been saved.



This message appears if no more storage locations are available (see page 14).



The following error message may appear on the display:

Error: No temperature sensor!
Solution: Connect temperature sensor and press key "OK".

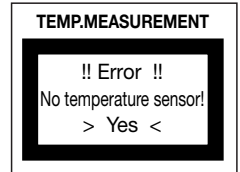

Error: No measuring head!
Solution: Connect measuring head and press key "OK".

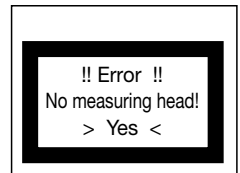

Error: Input error!
Solution: Check last entry and press key "OK".

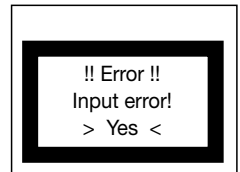

Error: Negative pressure!
Measuring connection +/- mixed up
The direction of flow does not conform with the arrow embossed on the body of the double regulating and commissioning valve.
Solution: Delete message by pressing the key "OK".

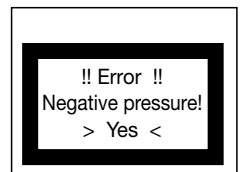

Error: No power pack!
This message appears if the submenu "charge batteries" is selected in the main menu "System-Setup" with no power pack being connected.
Solution: Plug in power pack and press key "OK". The red control lamp on the flow meter will light up.

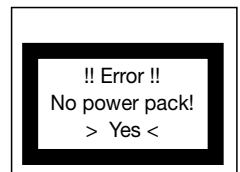

Please contact the company F.W. Oventrop GmbH & Co. KG in case of malfunction and for any further questions.



“OV-DMC 2” item no. 106 91 77 with double regulating and commissioning valve “Hydrocontrol R”