

# ASSEMBLY AND OPERATING MANUAL

---

Microcontroller-controlled temperature difference controller for solar thermal systems

## Oventrop REGTRONIC PX

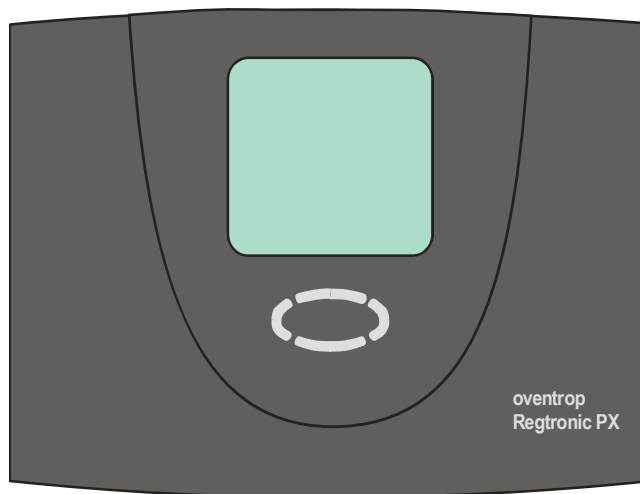

### **Important!**

Please read the instructions carefully before installing and operating the unit!

Failure to do so can void product warranty!  
Please keep the instructions in a safe place!

The unit described herein has been manufactured and inspected according to CE regulations.

**Table of contents:**

**1 SYMBOLS AND ABBREVIATIONS.....3**

**2 APPLICATIONS / FEATURES.....4**

2.1 BASIC INFORMATION .....4

2.2 APPLICATIONS .....4

2.3 UNIT FEATURES .....4

**3 SAFETY ADVICE .....5**

3.1 ESSENTIAL SAFETY ADVICE.....5

3.1.1 *Avoiding the risk of explosion* .....5

3.1.2 *Avoiding a lethal hazard due to electric shocks*.....5

3.1.3 *Avoiding a fire hazard* .....5

3.1.4 *Avoiding a risk of injury due to burning*.....5

3.1.5 *Preventing material damage*.....5

3.2 STRUCTURAL FEATURES OF THE INFORMATION ON DANGERS.....6

3.3 STRUCTURAL FEATURES OF THE INFORMATION ON MATERIAL DAMAGE AND ENVIRONMENTAL POLLUTION .....6

**4 UNIT INSTALLATION .....7**

4.1 OPENING THE UNIT.....8

4.2 WALL INSTALLATION.....8

**5 ELECTRICAL CONNECTIONS – OVERVIEW .....9**

5.1 GENERAL CONNECTION GUIDELINES:.....10

5.2 115 V CONNECTORS .....11

5.3 CONNECTING SENSORS.....11

5.4 SURGE PROTECTION MODULE .....11

**6 OPERATION / DISPLAY .....12**

6.1 OVERVIEW OF DISPLAY AND CONTROL BUTTONS .....12

6.2 SCREEN .....13

6.3 EXPLANATION OF ICONS .....13

6.4 BUTTON FUNCTIONS.....14

6.5 CONTROL UNIT USAGE EXAMPLE .....15

6.5.1 *Changing Target dTon temperature*.....15

**7 USER MENUS .....19**

7.1 OVERVIEW: MENU LAYOUT.....20

7.2 "INFO" MENU  .....21

7.3 "PROGRAMMING" MENU  .....21

**8 CONTROL UNIT FUNCTIONS.....22**

**9 DATA INTERFACE - DATASTICK® .....22**

9.1 DATASTICK® .....22

9.2 DATA LOGGING .....22

**10 TROUBLESHOOTING.....24**

10.1 REPORTABLE FAULTS.....24

10.2 NON-REPORTABLE FAULTS .....25

**11 TECHNICAL DATA .....26**

**12 RESISTANCE TABLE PT1000 .....26**

**13 OVENTROP CORP. - LIMITED WARRANTY.....27**

# 1 SYMBOLS AND ABBREVIATIONS

## Explanation of the icons used in this Operating Manual:

•	List
	Please note!
<b>i</b>	Usage tips / special information
→	User action / procedure
?	Inspection / check

## Frequently-used abbreviations

Abbreviations and symbols are sometimes used to improve legibility in this documentation and on the display of the

control unit itself. Their meanings are presented in the following table.

Abbreviat ion	Meaning	Abbrevia tion	Meaning
Start	Initial value	°F	Degrees Fahrenheit
Stop	Final value	dT	Temperature difference
>	Larger than	kWh	Energy output in kWh
h	Operating hours		

## 2 APPLICATIONS / FEATURES

### 2.1 Basic information

The controller is designed as a system control unit, meaning it is suitable for a variety of systems, depending on the functional layout and options selected. The information provided in the following therefore details the general functionality of the controller.

The various functional layouts and

corresponding connection diagrams are described in separate documents.

Since the controller can be used in many different ways, it is important that you read the Operating Manual before connecting and starting up the unit!

### 2.2 Applications

The controller is used to control the functionality of solar thermal plant by providing ancillary and protective features.

The controller is designed to be used in dry environments such as those found in residential, office and commercial interiors.

If you wish to use the unit for other purposes, please check applicable statutory regulations prior to use.

### 2.3 Unit features

The control unit can be used with many types of system.

Regardless of the specific application, the unit offers the following standard features:

- **Easy, menu-driven operation** using icons, simple text messages and four control buttons.
- All presets and control values **can be set digitally**
- Integrated **operating hours counter** for memory loading
- Powerful **system monitoring** functionality, with errors and faults displayed using icons and simple text
- Integrated **energy output measurement**: the output measurement set (optional accessory) can be used to record the energy produced by the solar plant
- Indefinite storage of all configured values if power supply fails.

- Various **protective features**, such as:

- System protection
- Collector protection
- Recooling
- Frost protection

- DataStick® interface

A DataStick® (optional accessory) provides a simple way to carry out data logging.

#### **Available accessories (optional):**

- PT1000 temperature sensors
- Flow transmitters for output measurement
- Radiation sensors
- DataStick® for data logging and programming using a PC

## 3 SAFETY ADVICE

### 3.1 Essential safety advice

#### 3.1.1 Avoiding the risk of explosion

- The unit is unsuitable for use in areas in which there is a risk of explosion. Never use the unit in an environment in which there is a risk of explosion.

#### 3.1.2 Avoiding a lethal hazard due to electric shocks

- Have all work on the electrical connections carried out by qualified specialist electricians only. The specialist personnel must have the knowledge, skills and experience necessary for handling electrical systems and working on the local power supply as specified at the installation location.
- Make sure that all regulations applicable at the installation location are observed. **Installation, connection to mains and use of the equipment shall be in accordance with the National Electrical Code.**
- Carry out all work on the unit only when this has been de-energized.
- Make sure that the current supply connections are not interchanged with those of the protective low-voltage area.
- Following all work, close the casing cover until it engages and tighten the locking screw hand-tight.
- Make sure that the mains connection can be interrupted with an external switch.
- The possibility of fatal electric shocks exists on damaged units. Only use the unit in flawless condition. Immediately shut down damaged units.
- A danger of electric shocks exists on tearing off connections with flexible cables due to tensile strain. Make sure that all cables are secured with a strain relief device.

#### 3.1.3 Avoiding a fire hazard

- Install the unit on a noncombustible surface only.

#### 3.1.4 Avoiding a risk of injury due to burning

- Only install the temperature sensors when the system has cooled down to hand temperature. Otherwise, there is a risk of injury due to burning on hot parts of the system.

#### 3.1.5 Preventing material damage

- Only use the unit in flawless condition. Damaged units may cause system malfunctions and damage its components.
- Prevent moisture or liquids from entering the unit. If moisture nevertheless enters the unit, immediately have the unit disconnected from the mains power supply by qualified specialist personnel. Before reusing the unit, contact your specialist dealer and carry out the measures stipulated by this party.
- Damage possible due to excessively high temperatures. Make sure that none of the unit's components is exposed to a temperature outside of the permissible operating range. Data on the permissible

operating range can be found in the section entitled "Technical data".

Make sure that none of the system's electrical components are damaged due to the temperatures which occur during operation. Only use materials which are suitable for the operating temperatures specified in the system documentation.

- Make sure that all of the system's electrical components are suitable for an operating voltage of 115 V / 50/60 Hz. The components may otherwise be damaged.
- Only operate the system briefly, and only for test purposes, in "Manual mode". Monitoring of maximum temperatures and sensor function is switched off in this operating mode. During uncontrolled operation, the regulator is not switched off automatically in the event of faults. Regulator or system malfunctions may occur.
- Damage to the temperature sensors or

malfunctions in the event of incorrectly positioned temperature sensors.

Only install the temperature sensors in the intended position on the collectors. Install the temperature sensors in such a way that good heat transfer is ensured. Route the cables to the temperature sensors separately from the mains cables.

- The inputs can be better protected with additional overvoltage protection (Sensor connection box). Malfunctions are possible on use of sensor connection boxes from third-party manufacturers. Use sensor connection boxes supplied by the manufacturer only.
- Damage to the casing on excessive tightening of the screws during installation. Tighten all screws hand-tight only.

### **3.2 Structural features of the information on dangers**



#### **DANGER**

Notes containing the word **DANGER** warn of a hazardous situation which leads to fatal or severe injuries.



#### **WARNING**

Notes containing the word **WARNING** warn of a hazardous situation which may possibly lead to fatal or severe injuries.



#### **CAUTION**

Notes containing the word **CAUTION** warn of a situation which may lead to slight or moderate injuries.

### **3.3 Structural features of the information on material damage and environmental pollution**

#### ***Notice!***

These notes warn of a situation which leads to material damage or environmental pollution.

## 4 UNIT INSTALLATION



### DANGER

**Lethal hazard on installation in areas in which there is a risk of explosion or on combustible surfaces.**

- Do not use the unit in areas containing explosive materials.
- Install the unit on a noncombustible surface only.



### DANGER

**Lethal hazard due to electric shocks when working on the electrical system.**

- Have all work on the electrical system carried out by qualified specialist personnel only.
- Prior to all work, make sure that the unit has been disconnected from the mains power supply.
- Following all work, close the casing cover until it engages and tighten the locking screw hand-tight.

### **Notice!**

**Damage to the casing on excessive tightening of the screws during installation.**

- Tighten all screws hand-tight only.



When integrated with the Regusol, removal of the controller is unnecessary!

### 4.1 Opening the unit

Before opening, ensure the unit is isolated from the power mains. If a locking screw has been attached to the cover of the unit, you will need to remove this first. The top of the casing snaps onto the lower part of the

unit on both sides. You can release the top of the casing by pulling gently on the sides of the cover (see picture) and then pivoting the cover upwards.

Continue to pull the cover upwards until it snaps into place. This will enable you to easily install and connect up the control unit

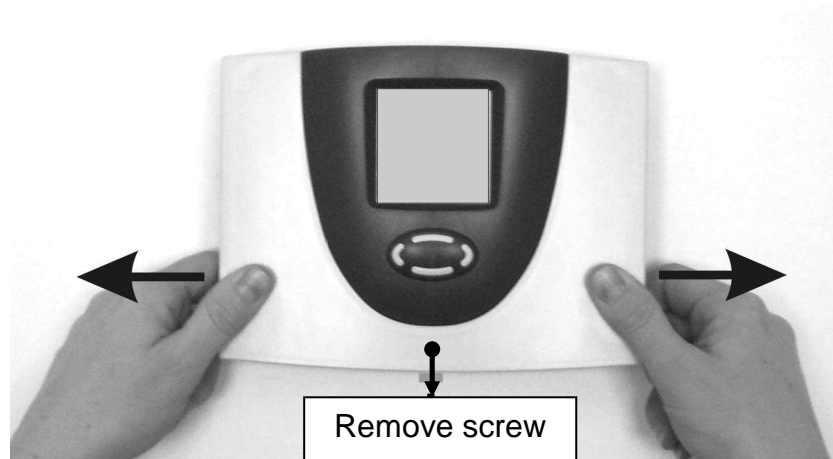

### 4.2 Wall installation

If installing the unit on a wall, proceed as follows:

- Drill the mounting holes to match the drilling template provided
- Screw in the two upper screws so that they project 6 mm from the wall
- Open the unit as described above and hang it on to these two screws. You can now screw in the two lower screws.
- **Tighten all screws only as much as necessary, to avoid damaging the lower part of the unit casing!**

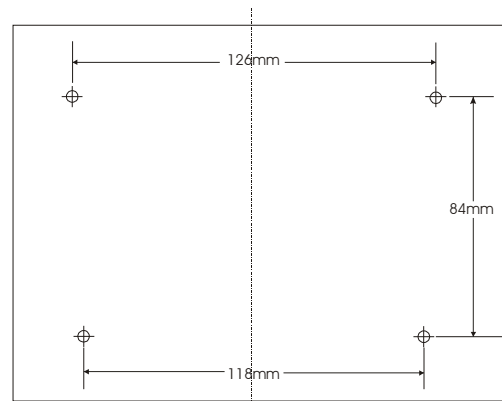



## 5 ELECTRICAL CONNECTIONS – OVERVIEW



### **DANGER**

**Lethal hazard due to electric shocks when working on the electrical system.**

- Have all work on the electrical system carried out by qualified specialist personnel only.
- Prior to all work, make sure that the unit has been disconnected from the mains power supply.
- Following all work, place the cover onto the casing until it engages and tighten the locking screw hand-tight.



### **DANGER**

**Lethal hazard due to electric shocks on tearing off connections with flexible cables due to tensile strain.**

- Make sure that all cables are secured with a strain relief device.

### **Notice!**

**Damage to the unit or malfunctions on use of unsuitable components.**

- Make sure that all of the system's components are suitable for an operating voltage of 115 V / 50/60 Hz.

### **Notice!**

**Malfunctions are possible on use of sensor connection boxes from third-party manufacturers.**

- Use sensor connection boxes supplied by the manufacturer only.

All electrical connections are made to the subassembly in the lower part of the unit. (SELV) connectors for sensors and flow transmitters are located on the right-hand side of the subassembly. The 115 V

connectors are located on the left-hand side. The number and location of 115 V and sensor connectors is described on the data sheet corresponding to the layout used.

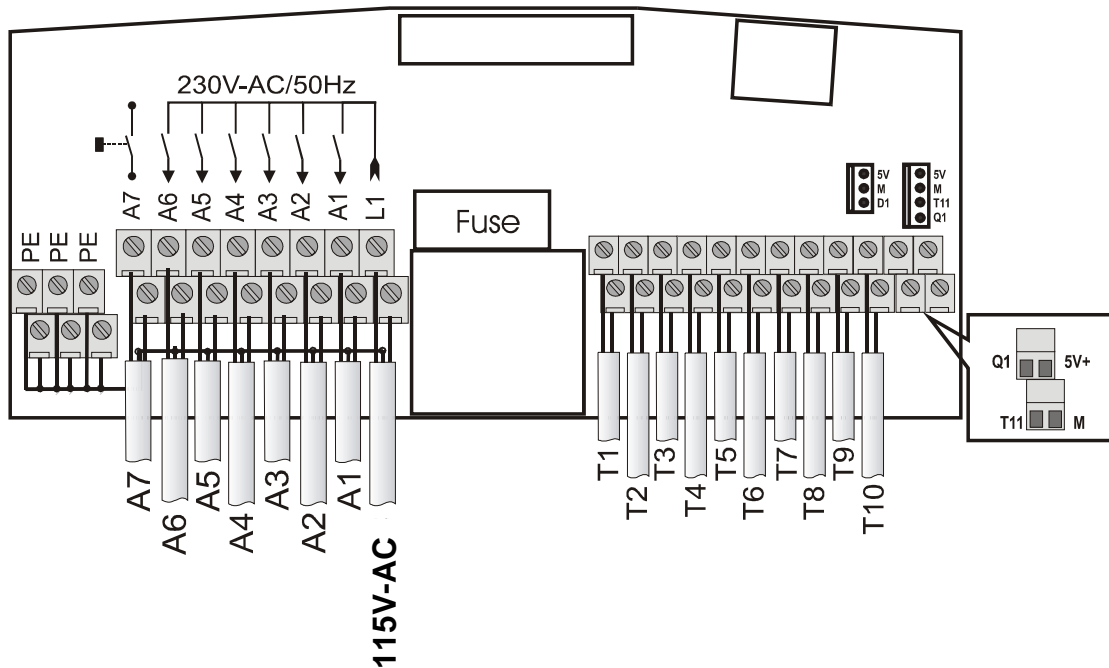

A7 PFC	6 x 115 V output	Line voltage	10 x PT1000 input	Grundfos sensor
-----------	---------------------	-----------------	----------------------	--------------------

### 5.1 General connection guidelines:

- When connecting all cables, strip the cable covering to a length of approx. 3" and the wires to a length of approx. 4".
- For flexible cables, a strain relief device must be present on the interior or exterior of the unit. On the 115 V side, this can be done by mounting a max. of 4 M12 cable screws. The ends of the wires must be covered with wire end ferrules. The cables are fed through openings in the unit.
- All ground leads must be attached to the terminals marked "PE" (potential earth).
- Installation, connection to mains and use of the equipment shall be in accordance with the National Electrical Code.

## **5.2 115 V connectors**

One mains connector is provided, plus a total of 6 115 V/50-60 Hz outputs.

-  If the control unit is wired directly into the mains, it must be possible to separate from power mains through a switch external to the unit. If the unit is connected using a cable and grounded plug, this switch is not necessary.
- i** The neutral lead terminals (N) are connected electrically and are not switched!
- i** All switched outputs (A1 to A6) are electronic 115 V AC make contacts. If you need potential-free contacts, then suitable accessory parts can be supplied.

Bear in mind the following points concerning the 115 V connectors:

- i** Depending on which functional layout is used, all outputs can be applied as switched outputs or – using block modulation – as pump power controls.
- i** All output activity is monitored electronically. A functional check is made automatically once a day, and can also be started manually from the Manual Operation menu.
- i** If the functional check fails, then this will close a potential-free contact (A7).

## **5.3 Connecting sensors**

The control unit works with high-precision platinum PT1000 temperature sensors. Between 2 and 10 sensors will be needed, depending on the system setup and functional layout. In some layouts the use of radiation sensors and flow transmitters will also be required. Inputs 1 to 7 are suitable for temperature sensors. Inputs 8 to 10 are universal inputs, which can be used for temperature sensors, radiation sensors or digital inputs.

### **Temperature sensor installation / cabling:**

- Mount the sensors in the corresponding places on the collector and storage tank. When doing so, ensure good temperature transfer, using heat-conductive paste if necessary.
- The temperature sensor cabling can be extended if required. Cross-sections required: lengths up to 49ft., 2 x 0.5 mm<sup>2</sup>; AWG22 lengths up to 164ft., 2 x 0.75 mm<sup>2</sup>, AWG20. Use shielded extension cables for long connections (e.g. to collector).

Do not insert shielded cable on the sensor side – clip it and strip it! The shield must be grounded (PE).

- Temperature sensors are connected according to the system setup. You do not need to observe polarity for the two wires when cabling temperature sensors.

 When laying sensor cabling, keep it away from 115 V cables: these can be a source of electrical interference under adverse conditions. Keep cabling at least 6" apart.

## **5.4 Surge protection module**

The control unit is provided with fine-level surge protection for all sensor inputs. As a rule, you will not need to take additional precautions for interior sensors. However, we recommend additional

protection for collector sensors and exterior sensors (sensor connection box with surge protection). Exterior protective devices must not contain any additional capacitors, as these may distort measurement readings.

# 6 OPERATION / DISPLAY

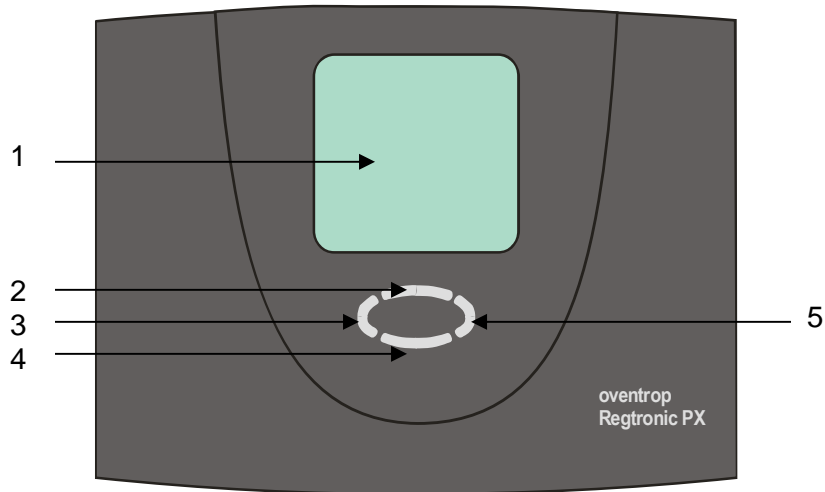

## 6.1 Overview of display and control buttons



Number	Description
1	Screen with graphical icons and 3-line simple text display
2	Page up / + button
3	Exit / Cancel / ESC button
4	Page down / - button
5	Select / Confirm / Enter button



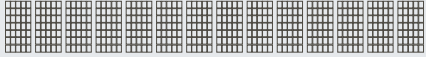
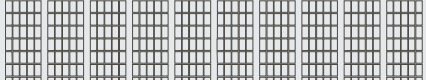

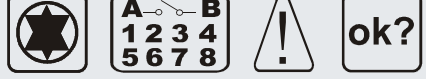





### 6.2 Screen

The screen displays graphical icons and simple text messages. The three-line simple text display is used to show display and programming values, relating these to measuring points.

	Main menus
	Measuring point reference
	Value / unit
	Additional information
	Status display

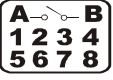
### 6.3 Explanation of icons

The following table describes the meanings of the various icons used.

Icon	Description	Display during operation
<b>Main menu</b>		
	"Info" menu	Icon flashes if selectable. Select with button  If only one icon is displayed, this menu is active
	"Programming" menu	
	"Manual operation" menu	
	"System Settings" menu	
<b>Status display</b>		
	Regulator active	Icon rotates if solar circuit pump is switched on
	Displays active switched outputs	Numbers of active switched outputs
	Indicates a system error	Display flashes if an error occurs in the system
	Used to confirm the saving of changed values	Value displayed can be rejected  or confirmed 





### 6.4 Button functions

The 4 control buttons provide simple and easy operation of the control unit. You can use the control buttons to:

- Display readings
- Make changes to unit settings

Use the icons on the display to guide you quickly through the various options, with clear indication of the current menu selection, reading or parameter.

The control buttons have the following functions:









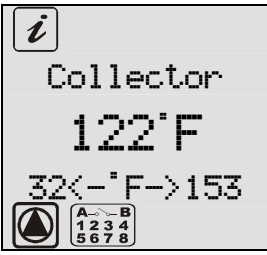

Button	Function	Description
	"Up" „+“	<ul style="list-style-type: none"> <li>• Page up in the menu</li> <li>• Change value: stepped increase of the value displayed If the button is pressed and held, values increase continuously</li> </ul>
	"Access" "Down" „-“	<ul style="list-style-type: none"> <li>• On the start screen: accesses a main menu</li> <li>• Page back in the menu</li> <li>• Change value: stepped decrease of the value displayed If the button is pressed and held, values decrease continuously</li> </ul>
	"Page left" "Exit"  "Cancel"	<ul style="list-style-type: none"> <li>• Page left in a main menu</li> <li>• Exit from a menu</li> <li>• Exit from a menu item</li> <li>• Cancel a modification made to a value without saving</li> </ul>
	"Page right" "Select" "Confirm"	<ul style="list-style-type: none"> <li>• Page right in a main menu</li> <li>• Select a menu item</li> <li>• Confirm and save a modification made to a value</li> </ul>















## 6.5 Control unit usage example

### 6.5.1 Changing Target dTon temperature







Once you have familiarized yourself with the menu descriptions in the "User menus" section, you can start making some operational changes. The example below describes one such operational procedure.









The starting point here is the "Info" menu, showing the current collector temperature. Objective: Change the parameter "Target dTon" from 7 K to 5 K, using the "Programming" menu.



		Escape: Exit the "Info" menu
		Page right: Select "Programming" menu
	 	Select "Programming" menu In the "Programming" menu, page until the submenu "Storage tank" is shown.
		Select submenu "Storage tank"
		In the submenu, page until the value "Target dTon" is shown.

 Storage tank 12 Tarsset dTon		Select value: the value "Target dTon" now begins to flash
 Storage tank 9 Tarsset dTon	 	Decrease the value until the chosen value is selected. Value continues to flash. Select "Confirm value"
 Storage tank 9 Tarsset dTon 	 or 	Icon  flashes. Confirm the change. Change is applied. Leave value as-is: change is not applied
    Flashes 12:09:24	2 x 	Exit submenu "Storage tank" Exit "Programming" menu

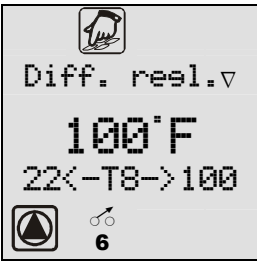

Corresponding settings in the "Programming" menu	
 <p>MultiRes 1 [Values] Diff. reel.</p>	<p>The MFR1 is configured in the "Programming" menu by selecting the submenu MFR1</p>
 <p>Diff. reel. 149°F maximum</p>	<p>Limiting the maximum temperature of the energy sink, such as for the storage tank accepting energy. The function is switched off once the energy sink sensor reaches the switch-off temperature.</p>
 <p>Diff. reel. 59°F minimum</p>	<p>Limiting the minimum temperature of the energy source, such as for the storage tank releasing energy. The function is only switched on once the energy source sensor reaches the switch-on temperature – in addition to the temperature difference required between the energy source and sink.</p>
 <p>Diff. reel. 12 dTmax</p>	<p>Switch-on difference between energy source and energy sink.</p>
 <p>Diff. reel. 6 dTmin</p>	<p>Switch-off difference between energy source and energy sink.</p>
 <p>Diff. reel. 0:00 Time 1: Start</p>	<p>Start time of the 1st time frame for the MFR.</p>

 <p>Diff. resol. 23:59 Time 1: Stop</p>	<p>Stop time of the 1st time frame for the MFR.</p> <p>Defining a time frame from 0:00 to 23:59 means the function will be permanently activated.</p>
 <p>Diff. resol. 12:00 Time 2: Start</p>	<p>Start time of the 2nd time frame for the MFR.</p>
 <p>Diff. resol. 12:00 Time 1: Start</p>	<p>Stop time of the 2nd time frame for the MFR.</p> <p>If the start time and stop time of a time frame are identical, this time frame will be deactivated, that is, will not be taken into account.</p>
 <p>Diff. resol. 18:00 Time 3: Start</p>	<p>Start time of the 3rd time frame for the MFR.</p>
 <p>Diff. resol. TROL 18:00 Time 3: Stop</p>	<p>Stop time of the 3rd time frame for the MFR.</p> <p>Time frame is also deactivated.</p>
<p><b>Corresponding display in the "Info" menu</b></p>	
 <p>Diff. resol. Δ 132°F 45&lt;-T7-&gt;132</p>  	<p>Display of the temperature of the energy source sensor in the "Information" menu, with minimum and maximum values. The corresponding measuring point – here T7 – is also displayed.</p>

	<p>Display of the temperature of the energy sink sensor in the "Information" menu, with minimum and maximum values. The corresponding measuring point – here T8 – is also displayed.</p>
	<p>Display of the functional status in the "Information" menu.  The 3rd line displayed on the screen shows the active ancillary features – here "Diff. regl.".</p>

## 7 USER MENUS

**Notice!**

**Damage to the unit or malfunctions in the event of incorrect settings in the menu.**

- Make sure that only qualified specialist electricians open and work with the "Manual mode", "Basic setting" or "System setting" menus.

To make the device as easy as possible to operate, all device, user and display functions have been divided into 4 groups (i.e. main menus).

Depending on which system setup and supplementary features have been selected, submenus will also be available within these main menus.





The four menus

- Info
- Programming
- Manual Operation
- System Settings

will either display information about your solar equipment or will let you enter system parameters.

The menu currently active is indicated by the corresponding icon displayed in the top row of the screen.

### 7.1 Overview: menu layout

Menu	Overview of available functions
Info 	Main menu for automated control of the solar equipment. <ul style="list-style-type: none"> <li>• Displays current readings</li> <li>• Displays the system status</li> <li>• Displays error messages</li> <li>• Displays hours of operation and energy output (if available)</li> </ul>
Programming 	Alteration/configuration of programmable settings (parameters) <p><b>Notice:</b> Changes can compromise system functionality. Settings and changes here should only be carried out by technicians!</p>
Manual Operation 	Manual activation and deactivation of attached pumps / valves <p><b>Notice:</b> Changes can compromise system functionality. Settings and changes here should only be carried out by technicians!</p>
System Settings 	Information about basic settings controlling system functionality. End users can view – but not change – these parameters. <p><b>Notice:</b> Changes can compromise system functionality. Settings and changes here should only be carried out by technicians!</p> <p>Available submenus, depending on the unit model:</p> <ul style="list-style-type: none"> <li>▪ Select basic layout</li> <li>▪ Select language</li> <li>▪ Collector protection</li> <li>▪ Recooling</li> <li>▪ System protection</li> <li>▪ Frost protection</li> <li>▪ Type 1-3 tube collector feature</li> <li>▪ Output measurement</li> </ul> <p>Multi-function regulator</p> <ul style="list-style-type: none"> <li>▪ Heating</li> <li>▪ Cooling</li> <li>▪ Threshold switch</li> <li>▪ Increased return flow</li> <li>▪ Wood boiler feature</li> <li>▪ Difference regulator</li> <li>▪ Circulation</li> <li>▪ Alarm</li> <li>▪ Timer</li> </ul>



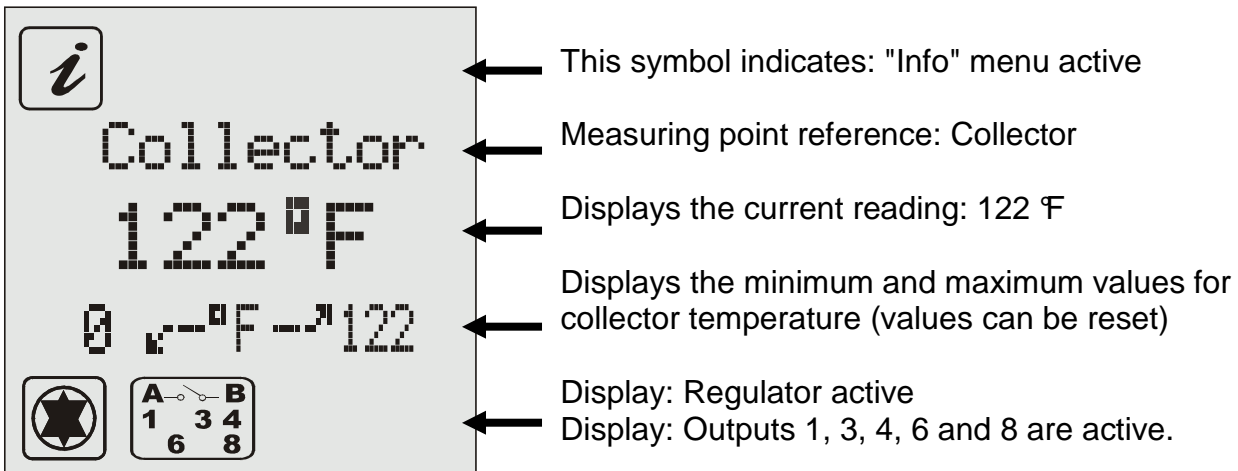

### 7.2 "Info" menu

The "Info" menu displays all of the readings and operational status values. Sample screen display from the "Info" menu:



**i** Note that only the regulator-specific values and those values required for the currently active supplementary features are shown!

If values can be reset, then they can be reset as follows:

- Select the value you want, using buttons  and 
- To reset the value, use button 
- Confirm message "OK?", using  for "No" or  for "Yes"

### 7.3 "Programming" menu

This menu can be used to check and change configurable parameters. In general the factory settings are configured to ensure the smooth operation of the system.

The number of values displayed depends on the unit type and which supplementary features have been configured. Only the values required for the unit are displayed.

Complex system set-ups require the programming of a variety of parameters. To keep the operation of the unit as simple as possible, these parameters have been grouped into submenus. Which submenus are available reflect the selected system setup selected and the active supplementary features.

## 8 CONTROL UNIT FUNCTIONS

The control unit is equipped with a wide range of functions for controlling and monitoring the solar power system. These functions can be classified as follows:

- Control functions for charging the storage tank
- Functions for protecting and monitoring the system
- Ancillary features

The "Control unit functions" document describes the available control unit functions.

The unit functions available depend on the system software and the selected basic layout. These functions are described in the instructions provided for the basic layouts.

## 9 DATA INTERFACE - DATASTICK®

The control unit is equipped with an innovative data interface. This interface enables the following optional functions:

- Data logging (with DataStick®)
- Remote system monitoring (with modem package)

**These functions are optional. To use them, you will need extra accessories (not included with the unit) such as a DataStick or modem!**

### 9.1 DataStick®

A DataStick® provides a simple way to carry out data exchange between the control unit and a PC. The system has the advantage that the PC does not need to be connected to the control unit itself, meaning that even a desktop PC can be used. Data is stored indefinitely on the DataStick® – even without power.

- The DataStick® can be connected to or disconnected from the port on the top of the unit without interrupting the unit's function; no special tools are required.

### 9.2 Data logging

By using a DataStick®, all system status, measurement and error message data can be recorded at intervals of 1-30 minutes (configurable) and then transferred to a standard PC. Each data record also contains the date and time of day.

Over 16,000 data records can be saved to the DataStick®.

Recording times depend on the configured recording interval, as follows:

Interval	Approx. max. time
1 minute	11 days
5 minutes	55 days
30 minutes	350 days

The recording function starts automatically once the DataStick® is inserted.

Parameters are stored on the DataStick® itself and can be modified as needed using "Data logging" on the "Programming" menu:

- Recording interval configuration
- Selection of simple recording (storage medium is written to until full) or cyclical recording (old data is overwritten)
- Reset logging storage (any data present is deleted, unit reboots)
- 

Accessories required:

- PC software for evaluating the data recorded
- PC interface adapter for the USB port
- SOLAREG® DataStick®

# 10 TROUBLESHOOTING



**DANGER**

Lethal hazard due to electric shocks when working on the electrical system.

- Have all work on the electrical system carried out by qualified specialist personnel only.

In principle, all system errors can be placed in one of two categories:

- Faults that are recognized by the control unit itself, and which it can therefore report

The symbol functions as a general error indicator.

- Faults that cannot be reported by the control unit

## 10.1 Reportable faults

Error displayed on screen	Possible causes	Suggested action
<p>flashing</p>	<ul style="list-style-type: none"> <li>• Disruption to sensor cable</li> <li>• Sensor defective</li> </ul>	<ul style="list-style-type: none"> <li>➔ Check cable</li> <li>➔ Check sensor resistance, replace sensor if necessary</li> </ul>
<p>flashing</p>	<ul style="list-style-type: none"> <li>• Short-circuit in sensor cable</li> <li>• Sensor defective</li> </ul>	<ul style="list-style-type: none"> <li>➔ Check cable</li> <li>➔ Check sensor resistance, replace if necessary</li> </ul>
<p>Circulation fault: no flow-through</p> <p>flashing</p> <p>Also displayed with energy output measurement:</p>	<ul style="list-style-type: none"> <li>• Fault in pump connection</li> <li>• Pump defective</li> <li>• Air in the system</li> <li>• Flow meter defective</li> <li>• Connection to flow meter defective</li> <li>• Disruption to sensor cable</li> <li>• Sensor defective</li> </ul>	<ul style="list-style-type: none"> <li>➔ Check cabling</li> <li>➔ Replace pump</li> <li>➔ Vent system</li> <li>➔ If visible, check whether the fly-wheel of the meter moves when the system is running</li> <li>➔ Check cable</li> <li>➔ Check cable</li> <li>➔ Check sensor resistance, replace sensor if necessary</li> </ul>



## 10.2 Non-reportable faults

The following table helps identify and evaluate the source of faults and malfunctions that the system cannot display



on its own. If you are unable to resolve the fault using the descriptions below, then please contact your supplier or installer.



**DANGER**

**Lethal hazard due to electric shocks when working on the electrical system.**

- Have all work on the electrical system carried out by qualified specialist personnel only.

Error display	Possible causes	Suggested Action
No display possible 	<ul style="list-style-type: none"> <li>• 115 V mains power supply unavailable</li> </ul>	<ul style="list-style-type: none"> <li>➔ Switch on or connect up control unit</li> <li>➔ Check fuses for building power supply</li> </ul>
	<ul style="list-style-type: none"> <li>• Fuse inside unit defective</li> </ul>	<ul style="list-style-type: none"> <li>➔ Check fuse, replace if necessary with new 2A (T) fuse.</li> <li>➔ Check 115 V components for short-circuits</li> </ul>
	<ul style="list-style-type: none"> <li>• Unit defective</li> </ul>	<ul style="list-style-type: none"> <li>➔ Contact your supplier</li> </ul>
Control unit inoperative	<ul style="list-style-type: none"> <li>• Unit is in manual operation mode</li> <li>• Switch-on condition not yet achieved.</li> </ul>	<ul style="list-style-type: none"> <li>➔ Exit "Manual Operation" menu.</li> <li>➔ Wait until switch-on condition achieved</li> </ul>
"Pump" icon turns, but pump is not working 	<ul style="list-style-type: none"> <li>• Disruption to pump connection.</li> <li>• Pump has seized up.</li> <li>• Switched output has no current.</li> </ul>	<ul style="list-style-type: none"> <li>➔ Check cable to pump</li> <li>➔ Ensure pump can run smoothly</li> <li>➔ Contact your supplier.</li> </ul>
Temperature display fluctuates strongly at short intervals	<ul style="list-style-type: none"> <li>• Sensor cabling has been laid near to 115 V cables</li> <li>• Long sensor cables extended using unshielded leads</li> <li>• Unit defective</li> </ul>	<ul style="list-style-type: none"> <li>➔ Reposition sensor cabling Shield sensor leads</li> <li>➔ Shield sensor leads</li> <li>➔ Contact your supplier</li> </ul>

# 11 TECHNICAL DATA

Electronic temperature differential controller (sensing control), 10 inputs, 6 outputs, 1 potential free output, independently mounted, continuous operation.

<b>Housing</b>	
Material/Installation	100% recyclable 3 part ABS housing Even wall mounted with screws
Dimensions W x H x D; weight	6.9 x 5.3 x 2.2 in; approx. 12.7 oz
Protection class	IP20
<b>Electrical specifications</b>	
Operating voltage	AC 115 Volts (+/- 15%), 50/60Hz, 1A
Control power consumption	< 1Watt
Max. cable cross-section 115V connections	2.5 mm <sup>2</sup> , 14 AWG rated at 221°F
Inputs - 10 for temperature sensors, varistor protected	PT1000 probe
Input - 11 for temperature sensor/flow sensor, varistor protected	Grundfos sensor
Temperature sensor measuring range	PT1000, silicone cable with probe 1 kΩ at 32°F -22°F to +482°F
Output - 1-6	115V~, 1A, cos φ > 0,7
Output - 7: potential-free	115V~, 1A, cos φ > 0,7
Fuse protected	Fine-wire fuse 5 x 20mm, 4A/T (4 amperes, delayed-action fuse)
Rated impulse voltage	4kV
Type 1 action	Type 1.B and Type 1.Y
Ball Pressure Test	167°F
Operation:	By 4 pushbuttons in the front of the housing
Software class	A
<b>Miscellaneous</b>	
Recommended flow sensor	PVM 1.5/90 1500l/h, Tmax >=90°C, 1l/pulse
Operating temperature	32 T122°F
Ambient temperature	14T149°F
Humidity	max. 60 %, non condensing

Subject to change in accordance with technical advance!

# 12 RESISTANCE TABLE PT1000

The temperature sensors can be checked for proper function using the following temperature resistance table and an ohmmeter:

Temperature in °F	Resistance in Ohm	Temperature in °F	Resistance in Ohm
-22	882	140	1232
-4	921	158	1271
14	960	176	1309
32	1000	194	1347
50	1039	115	1385
68	1077	248	1461
86	1116	284	1535
104	1155	392	1758

## 13 OVENTROP CORP. - LIMITED WARRANTY

Oventrop Corp. warrants to its "Customers" that all Oventrop products, used for heating and plumbing applications and sold in accordance with these warranty provisions, shall be free from defects in material and workmanship. "Customer" as used herein shall mean an end-user of Oventrop products.

This limited warranty shall last two (2) years for electric parts, and five (5) years for all other products from the date of purchase, unless otherwise specified in writing.

In order to be eligible for a warranty claim, Products sold

- (1) must be installed and maintained professionally according to the relevant assembly instructions and the product manual,
- (2) must only be used for purposes provided in the Oventrop Corp.'s product description or assembly instructions,
- (3) must be exposed only to gaseous or liquid media approved for the product by Oventrop Corp., and
- (4) shall not be combined with products of other manufacturers unless otherwise stated in the product manual.

Oventrop Corp.'s sole obligation hereunder shall be, at its option, to issue credit, repair or replace any component or part thereof which is proved to be defective. The limited warranty does not cover cost for transportation or labor charges (including installation and removal) unless such charges are authorized in writing in advance by the Oventrop Corp. Any repairs without the express written consent of Oventrop Corp. shall render this limited warranty invalid. Oventrop Corp. disclaims allowances for dismounting and consequential losses and damages.

Warranty claims must be received by Oventrop Corp. within the applicable warranty period and within thirty (30) days from the cause for the claim occurred or was discovered. Upon receipt of prompt notice of a warranty claim, Oventrop Corp. shall have ten (10) business days in which to determine whether it acknowledges responsibility for any asserted defects in material or workmanship and the appropriate action to be taken.

This limited warranty and any claims arising from the breach of warranty, or any other claim arising hereunder, shall be governed and construed under the laws of the State of New York. No other persons than Oventrop Corp. employees have any expressed or implied authority to bind Oventrop Corp. to any agreement or warranty of any kind without the express written consent of Oventrop Corp.

### **Disclaimer of Warranties:**

OVENTROP CORP. DISCLAIMS ANY WARRANTY NOT PROVIDED HEREIN INCLUDING THE IMPLIED WARRANTY OF MERCHANTABILITY AND IMPLIED WARRANTY OF FITNESS FOR A PARTICULAR PURPOSE. IT IS EXPRESSLY UNDERSTOOD THAT OVENTROP CORP. IS NOT RESPONSIBLE FOR ANY CONSEQUENTIAL OR OTHER DAMAGES THAT MAY ARISE FROM USING OVENTROP CORP. SYSTEM COMPONENTS. DAMAGE RESULTING FROM WATER FREEZING IN THE TUBING DOES NOT CONSTITUTE A DEFECT IN MATERIAL OR WORKMANSHIP, AND SHALL NOT BE COVERED BY THIS WARRANTY. OVENTROP-TUBING MAY NOT BE STORED IN DIRECT SUNLIGHT FOR ANY PERIOD LONGER THAN THREE WEEKS, OR THIS LIMITED WARRANTY BECOMES INVALID. OVENTROP CORP. DISCLAIMS ANY STATUTORY OR IMPLIED WARRANTY OF HABITABILITY. OVENTROP CORP. FURTHER DISCLAIMS ANY RESPONSIBILITY FOR LOSSES, EXPENSES, INCONVENIENCES, SPECIAL, INDIRECT, SECONDARY, INCIDENTAL, OR CONSEQUENTIAL DAMAGES ARISING FROM OWNERSHIP OR USE OF THE ARTICLES SOLD HEREUNDER. THERE ARE NO WARRANTIES WHICH EXTEND BEYOND THE FACE HEREOF.