

# INSTRUCTIONS FOR INSTALLERS

---

## **Oventrop REGTRONIC PX**

### **Important!**

Please read the instructions carefully before installing and operating the unit!

Failure to do so can void product warranty!  
Please keep the instructions in a safe place!

The unit described herein has been manufactured and inspected according to CE regulations.



**Notice!**

**Damage to the unit or malfunctions in the event of incorrect settings in the menu.**

**Setting the wrong parameters can compromise the functionality of the control unit and solar equipment**



- Make sure that only installers or qualified technical personnel configure or modify parameters in the System Settings menu.

**Table of contents:**



<b>1</b>	<b>"SYSTEM SETTINGS" MENU"/ CHANGES TO THE SYSTEM</b> .....	<b>3</b>
1.1	"MANUAL OPERATION" MENU  .....	5
1.2	"SYSTEM SETTINGS" MENU  .....	5
1.3	CONFIGURING A MULTI-FUNCTION REGULATOR .....	6
<b>2</b>	<b>USING A DATASTICK®</b> .....	<b>8</b>
2.1	FACTORY SETTINGS .....	8
2.1.1	<i>Restoring factory settings</i> .....	8
2.1.2	<i>Saving/loading configuration parameters</i> .....	8
2.2	UPDATING SYSTEM SOFTWARE.....	8

# 1 "SYSTEM SETTINGS" MENU"/ CHANGES TO THE SYSTEM

During normal operation, the "System Settings" menu solely displays parameters and does not allow them to be altered. This prevents accidental changes. **To change parameters, this menu must be activated within one minute of switching on the unit.**

While the system is running, changes can be made using the System Settings menu by pressing the top , bottom  and right-hand  button simultaneously. Once the user is in the menu, no time limits apply.

**The System Settings menu "locks" itself automatically one minute after the unit has been switched on and one minute after the user has exited the menu.**



The System Settings menu is used to select the basic schematics and the language, and also to activate or deactivate the available protective and ancillary features. The buttons  and  are used to page through the various submenus. The status – e.g. "On" or "Off" – is also shown next to the name of each submenu. Submenus are selected by using the  button.

Allocation of layout no. to system number: X1010 = 3301, X1020 = 3302, X1030 = 3303, X2010 = 3304, X2020 = 3305, X2030 = 3306.

Note: 3300 is the initial software set!

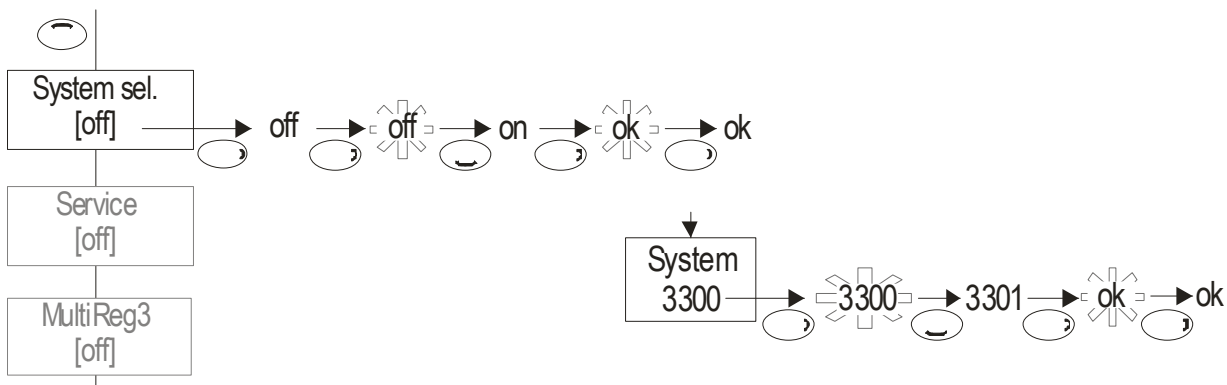
**Example:** change system 3300 to 3301



Menu	Overview of available functions
<p>Programming</p> 	<p>Alteration/configuration of programmable settings (parameters)</p> <p><b>Notice:</b> Changes can compromise system functionality. Settings and changes here should only be carried out by technicians!</p>
<p>Manual Operation</p> 	<p>Manual activation and deactivation of attached pumps / valves</p> <p><b>Notice:</b> Changes can compromise system functionality. Settings and changes here should only be carried out by technicians!</p>
<p>System Settings</p> 	<p>Information about basic settings controlling system functionality. End users can view – but not change – these parameters.</p> <p><b>Notice:</b> Changes can compromise system functionality. Settings and changes here should only be carried out by technicians!</p> <p>Available submenus, depending on the unit model:</p> <ul style="list-style-type: none"> <li>▪ Select basic layout</li> <li>▪ Select language</li> <li>▪ Collector protection</li> <li>▪ Recooling</li> <li>▪ System protection</li> <li>▪ Frost protection</li> <li>▪ Type 1-3 tube collector feature</li> <li>▪ Output measurement</li> </ul> <p>Multi-function regulator</p> <ul style="list-style-type: none"> <li>▪ Heating</li> <li>▪ Cooling</li> <li>▪ Threshold switch</li> <li>▪ Increased return flow</li> <li>▪ Wood boiler feature</li> <li>▪ Difference regulator</li> <li>▪ Circulation</li> <li>▪ Alarm</li> <li>▪ Timer</li> </ul>

## 1.1 "Manual Operation" menu

### **Notice!**

**Damage to the unit or malfunctions in the event of incorrect settings in the menu.**

- Make sure that only qualified specialist electricians open and work with the "Manual mode" or "Basic setting" menus.

The solar power system can be operated manually for servicing and testing. This also lets you switch on/off the 115 V switched outputs. No automated control of the system is available during manual operation. To prevent system instability, the system switches back to "Display" mode after approx. 8 hours in manual mode, re-activating automated control.

The option "Follow-on manual" can be used to set manual operation for a set period. During this period, you can exit from the "Manual Operation" menu and carry out servicing or testing. Any values set in the menu will stay in effect for this period of time, allowing you use the "Info" menu to view and monitor readings and the system status.

## 1.2 "System Settings" menu

### **Notice!**

**Damage to the unit or malfunctions in the event of incorrect settings in the menu.**

- Make sure that only qualified specialist electricians open and work with the "Manual mode" or "Basic setting" menus.

During normal operation, the "System Settings" menu only displays parameters and does not allow them to be altered. This prevents accidental changes. **To change parameters, this menu must be selected within one minute of switching on the unit.**

While the system is running, changes can be made using the System Settings menu

by pressing the top , bottom 

and right-hand  button simultaneously.

Once the menu has been activated, no further time limits apply.

**The System Settings menu "locks" itself automatically one minute after the unit has been switched on and one minute after the user has exited the menu.**





The System Settings menu is used to select the basic schematics and interface language, as well as to activate or deactivate the available protective and





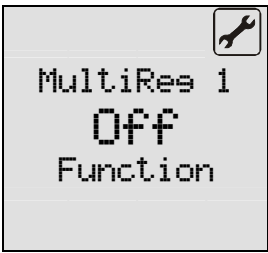

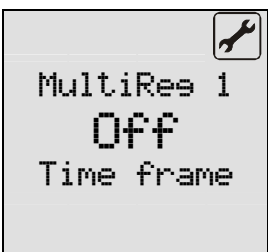
supplementary features. The buttons 

and  are used to page through the various submenus. The status – e.g. "On" or "Off" – is also shown next to the name of each submenu. Submenus are selected by

using the  button.

### 1.3 Configuring a multi-function regulator

 <p>MultiRes 1 [off]</p>	<p>Select the multi-function regulator (MFR for short) you want in the "System Settings" menu. Factory setting: MFR = Off</p>
 <p>MultiRes 1 Off Function</p>	<p>Select (activate) the submenu of the selected MFR. Function is "Off", i.e. no regulator functionality is currently active.</p>
 <p>MultiRes 1 Diff. real. Function</p>	<p>Select the specific MFR function to use. For this example we will use a difference regulator. Available functions: thermostat cooling, thermostat heating, threshold switch, increased return flow, wood boiler, difference regulator, circulation, alarm and timer</p>
 <p>MultiRes 1 Off Time frame</p>	<p>The MFR's functionality can be linked to specific time frames. "Off": No time frame active MFR function = continuously active</p>
 <p>MultiRes 1 On Time frame</p>	<p>Time frame linking is active, i.e. the selected function cannot be activated continuously, but is time-limited and only works within the specified time frame.</p>
 <p>MultiRes 1 TF 7 Source sensor<math>\Delta</math></p>	<p>Selects the temperature sensor for the energy source. (Any available temperature sensor can be selected, even if it is currently being used by another function.)</p>

 <p>MultiRes 1 TF 8 Sink sensor ▾</p>	<p>Selects the temperature sensor for the energy sink. (Any available temperature sensor can be selected, even if it is currently being used by another function.)</p>
 <p>MultiRes 1 None Link select</p>	<p>Theoretically, each MFR can be linked to other outputs – i.e. the status (active, inactive) of another output chosen by the user influences the control process of the current MFR</p>
 <p>MultiRes 1 Los. AND Link type</p>	<p>Select the link usage logic. "AND": the output is only on if A1 to A7 also fulfill these conditions and the switch-on conditions for MultiReg 1 are also met</p>
 <p>MultiRes 1 XX010X1 Link A1-A7</p>	<p>Select the output usage logic AND: MultiReg 1 (A6) is only on if:</p> <ol style="list-style-type: none"> <li>1. Its switch-on conditions are met AND</li> <li>2. A4, A7 are on (1) and A3, A5 are off (0). A1 and A2 are not considered in this scenario (X)</li> </ol> <p>Note: The user's output (here: A6) cannot be edited</p>
 <p>MultiRes 1 Los. OR Link type</p>	<p>Select the link usage logic. "OR": the output is only on if at least one of the conditions are fulfilled – including the switch-on conditions for MultiReg 1</p>
 <p>MultiRes 1 XX010X1 Link A1-A7</p>	<p>Select the output usage logic OR: MultiReg 1 (A6) is only on if:</p> <ol style="list-style-type: none"> <li>1. Its switch-on conditions are met AND</li> <li>2. A4 or A7 is on (1), or A3 or A5 is off (0). A1 and A2 are not considered in this scenario (X)</li> </ol> <p>Note: The user's output (here: A6) cannot be edited</p>
 <p>MultiRes 1 [on] Diff. resl.</p>	<p>Exit the submenu MFR1 in the "System Settings" menu. The activated function is shown as text on the screen.</p>

## 2 USING A DATASTICK®

Installers or technicians can use a DataStick® for the following tasks:

- Updating unit parameters
- Saving/loading factory settings
- Updating system software

### **2.1 Factory settings**

Factory settings can be saved, loaded or restored in the "System Settings" menu.

This also makes it possible to transfer configuration data from one control unit to another, for example.

#### **2.1.1 Restoring factory settings**

Menu item "Factory settings":

- Off
- On: Restores the default factory settings

#### **2.1.2 Saving/loading configuration parameters**

Menu item "Factory settings" Parameters:

The DataStick® should only ever be inserted or removed while this menu is active. If the DataStick® has been previously used for programming purposes, then other menus in the system will ask the user if the software on the DataStick® should be loaded! Stick-based parameter backups will not have this effect.

- Off
- Save
- Stick available: Message "OK"
  - Stick unavailable: Message "OK" (the data will be sent, although it cannot be stored)
- Load
  - Stick available, system no. and system version on the stick match the data in the control unit: Message "OK"
  - Stick available, system no. on the stick matches the data in the control unit, but the version is different: Message "Chk. par.": the installer needs to check and verify the parameters.
  - System no. does not match the system no. in the control unit: Message "Error"

### **2.2 Updating system software**

First insert the DataStick. If the DataStick contains a software package that is valid for this unit, then the screen will display "Copy DataStick start?". Press the "OK" button twice to confirm, and the copy

process will start. Once copying has finished, the unit will ask you to remove the DataStick. The control unit will then reboot.